

1: 9	↑	Serie	44
2: 9	↗		
3: 8	↘		
4: 9	←		
5: 9	↙		
Total			44

6: 9	→	Serie	43
7: 8	↗		
8: 9	↖		
9: 8	↗		
10: 9	↘		
Total			87

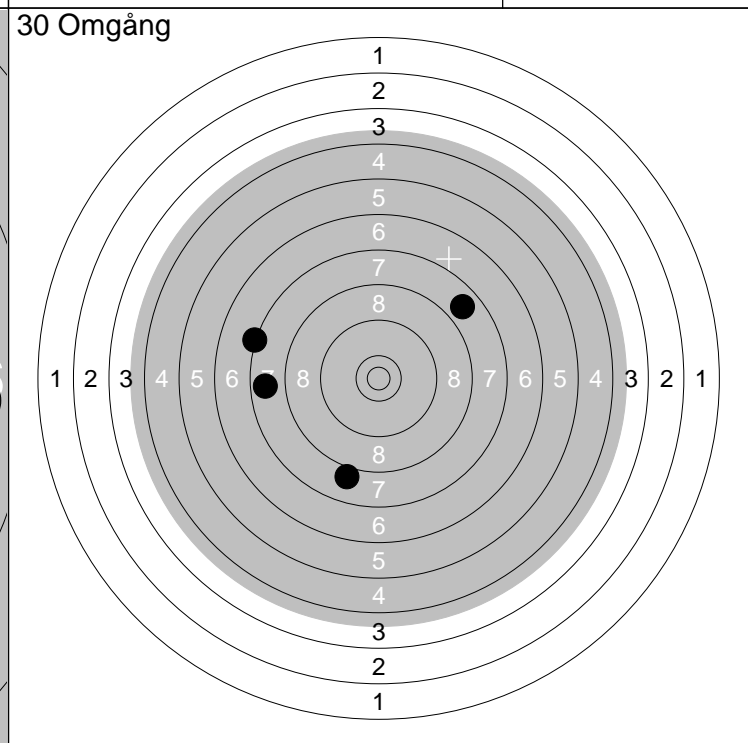
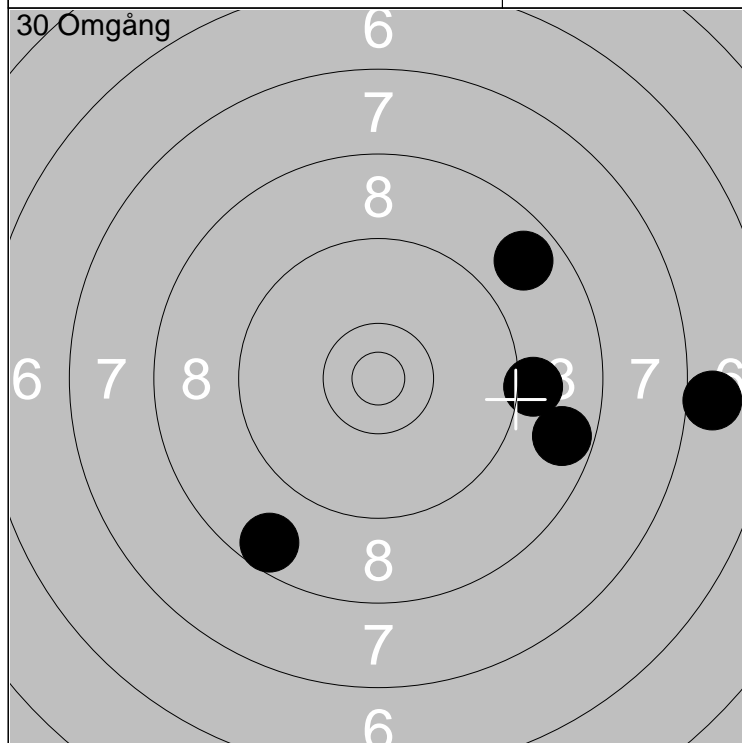

11: 7	→	Serie	40
12: 8	→		
13: 8	↗		
14: 9	→		
15: 8	↙		
Total			127

16: 7	←	Serie	29
17: 7	←		
18: 0	↗		
19: 7	↗		
20: 8	↙		
Total			156

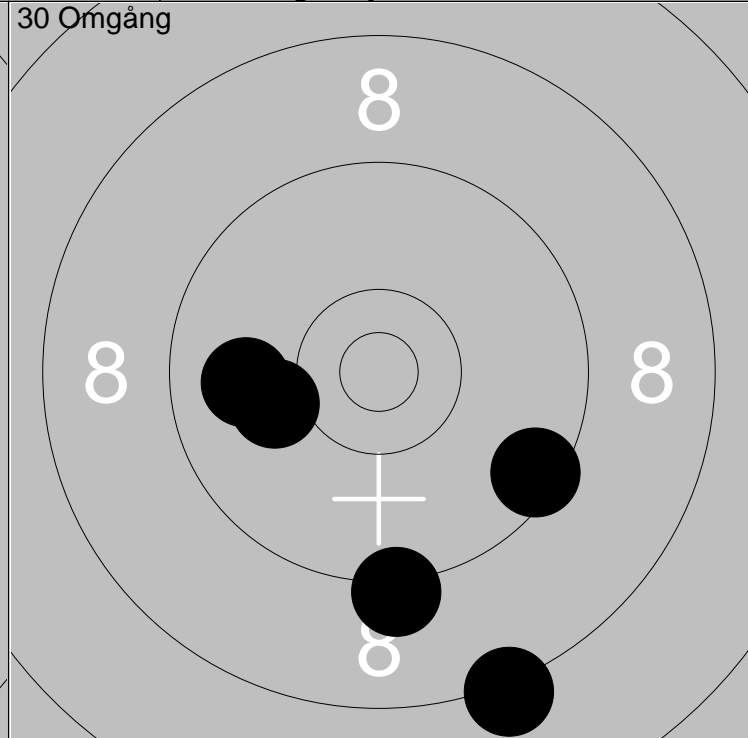
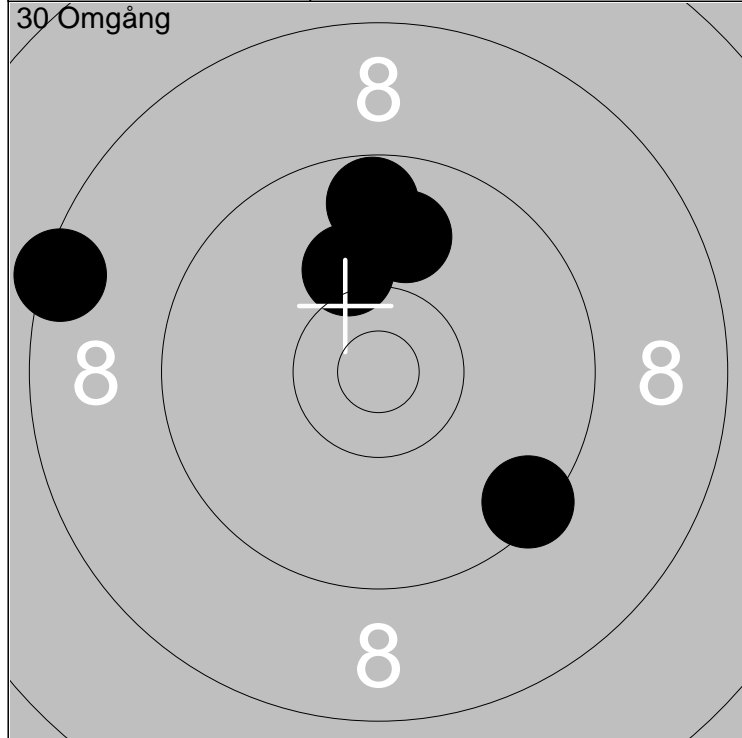

1: 9	↘	Serie	45
2: 10	↗		
3: 9	↗		
4: 9	↗		
5: 8	↖		
Total		45	

6: 9	↘	Serie	45
7: 9	↖		
8: 10	↖		
9: 9	↘		
10: 8	↘		
Total		90	

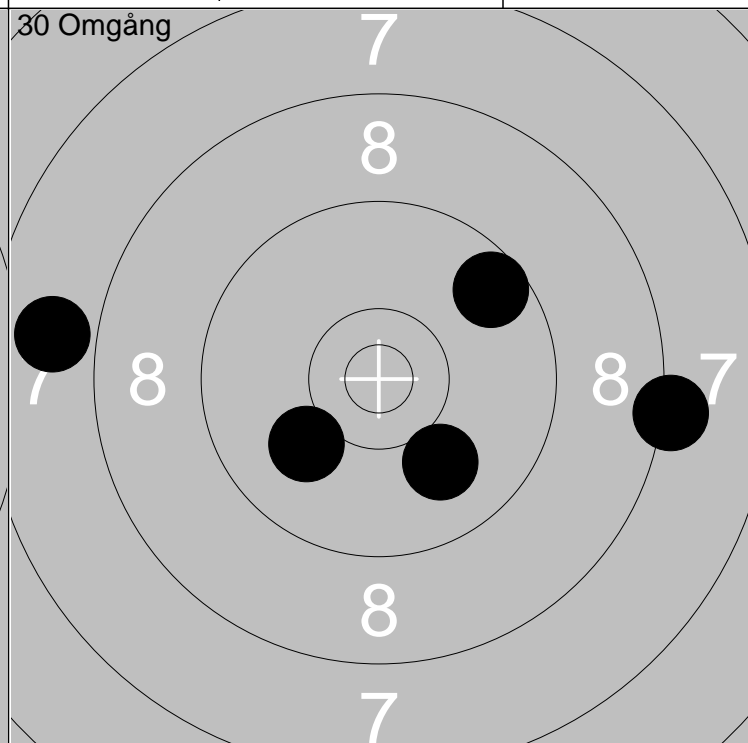
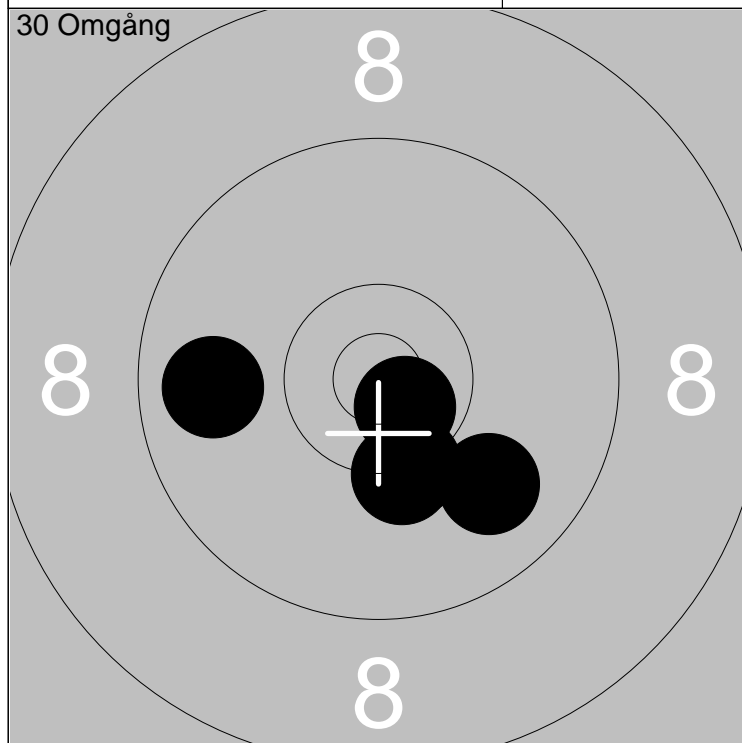

11: 10	↘	Serie	48
12: 9	↘		
13: *10	↘		
14: 9	↖		
15: *10	↘		
Total		138	

16: 10	↖	Serie	44
17: 7	↖		
18: 9	↗		
19: 8	↗		
20: 10	↘		
Total		182	

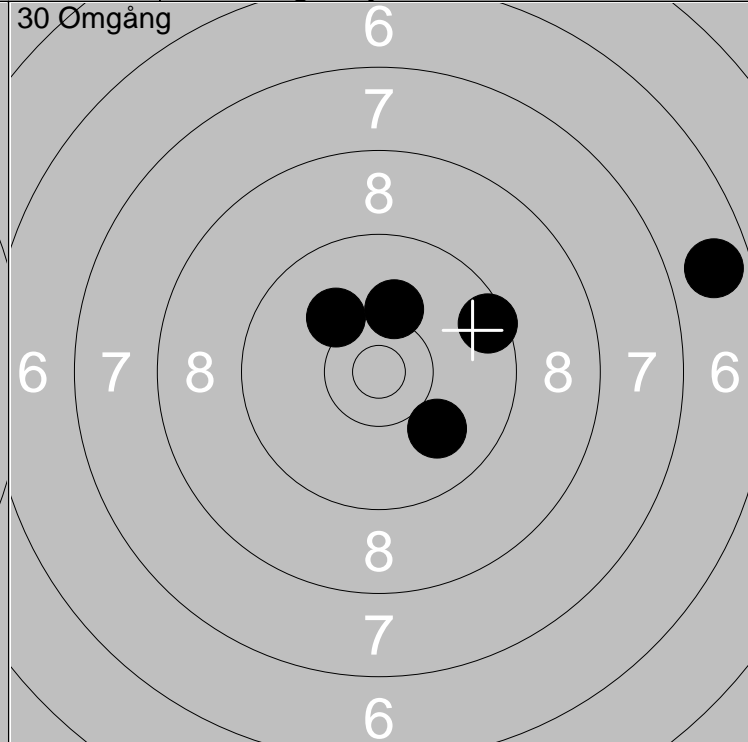
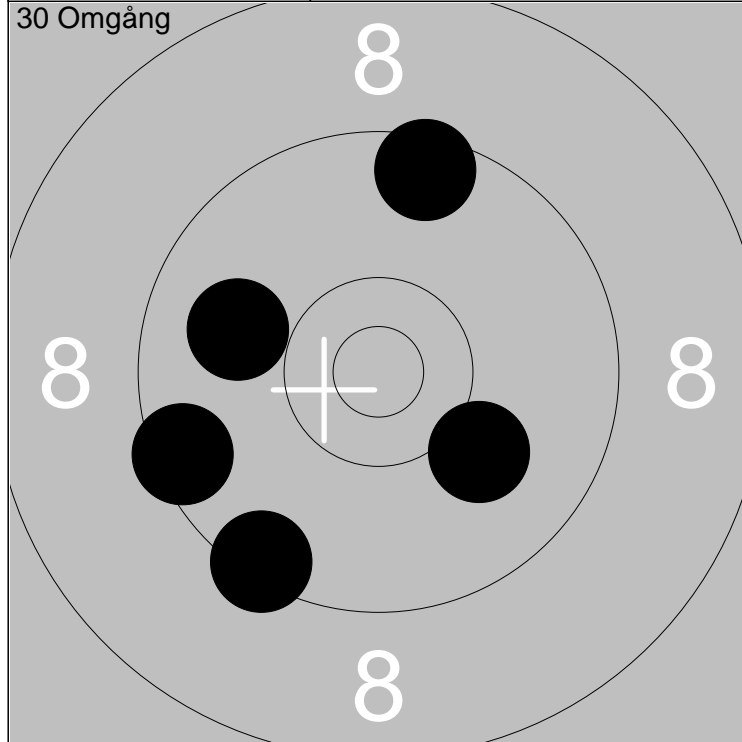

1: 9	←
2: 10	↘
3: 9	↖
4: 9	↙
5: 9	↑

Serie	46
Total	46

6: 6	→
7: 10	↑
8: 10	↖
9: 9	↗
10: 10	↘

Serie	45
Total	91

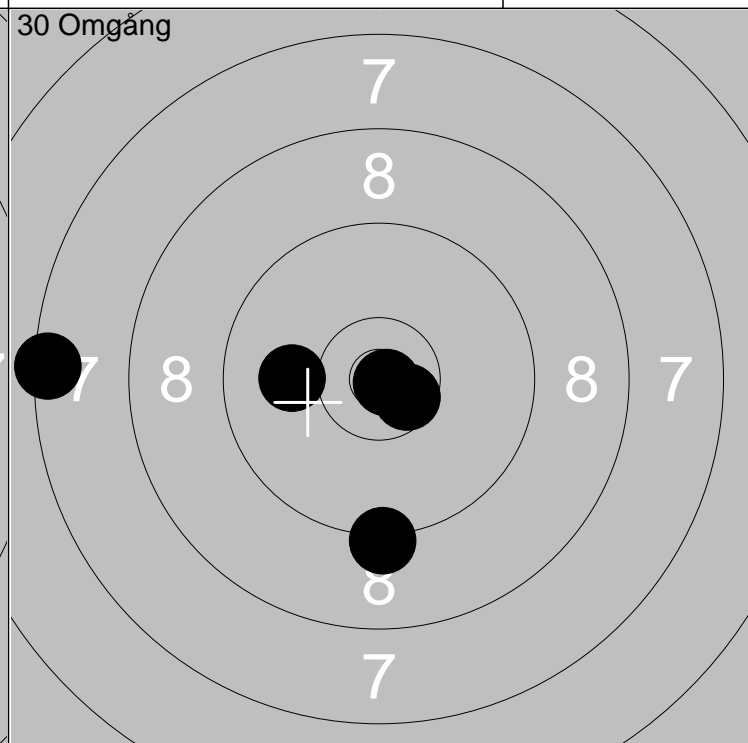
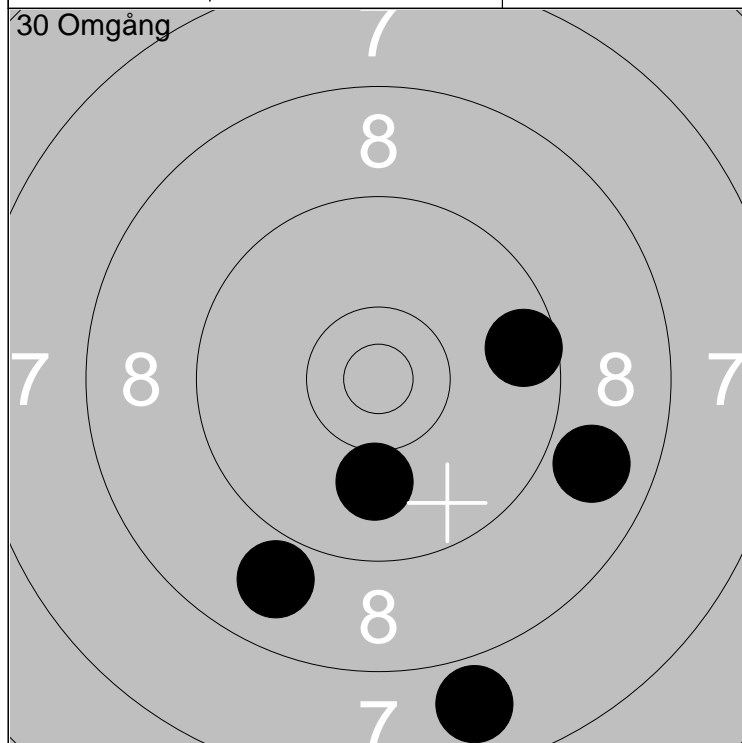

11: 8	→
12: 10	↓
13: 7	↓
14: 8	↙
15: 9	→

Serie	42
Total	133

16: 10	←
17: 9	↓
18: *10	→
19: 7	←
20: *10	↘

Serie	46
Total	179

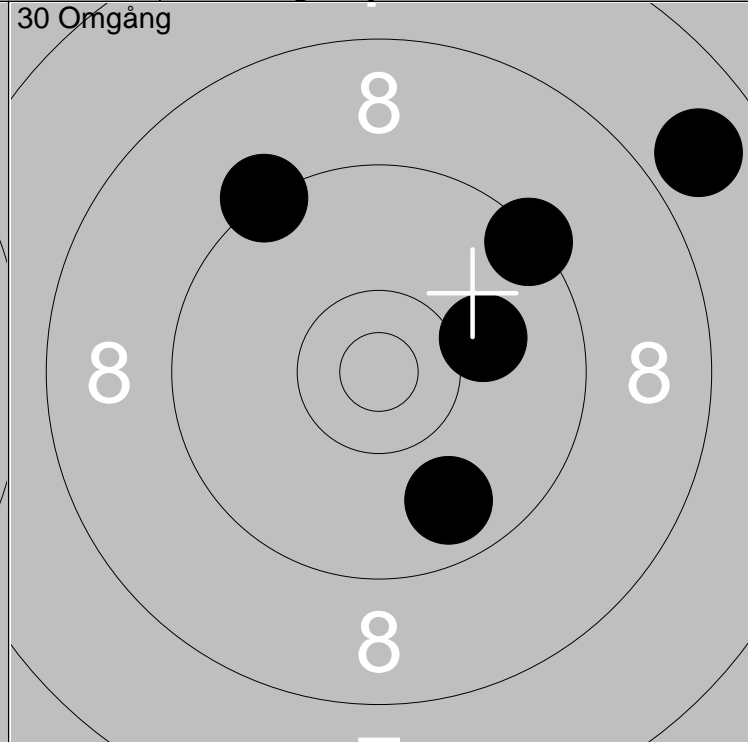
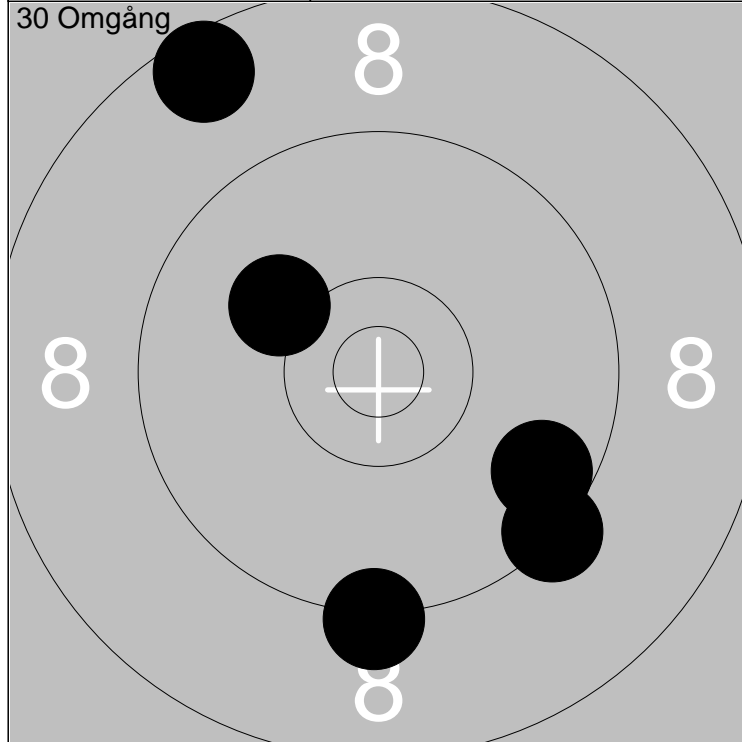

1: 9	↘	Serie	45
2: 10	↗		
3: 9	↘		
4: 9	↓		
5: 8	↗		
Total		45	

6: 10	→	Serie	44
7: 7	↗		
8: 9	↘		
9: 9	↗		
10: 9	↗		
Total		89	

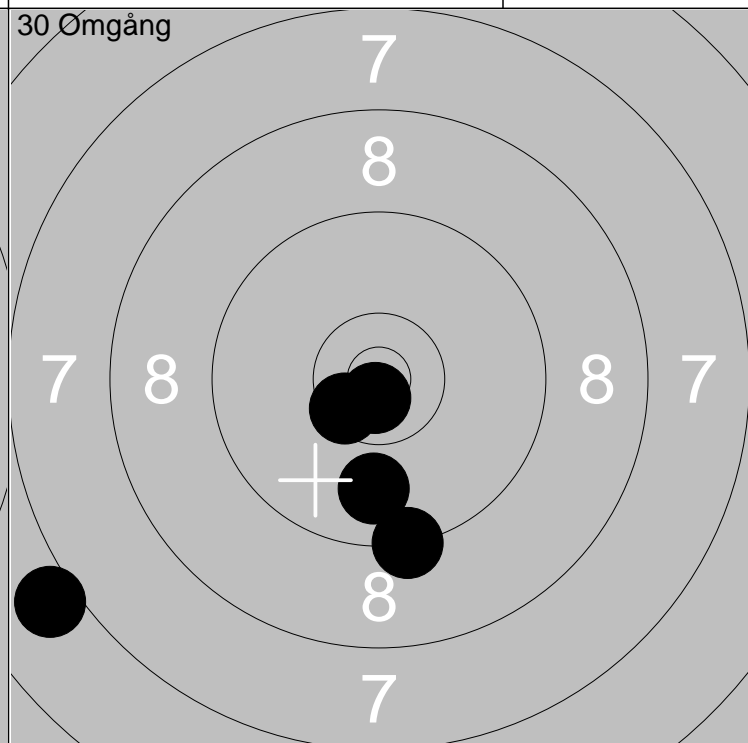
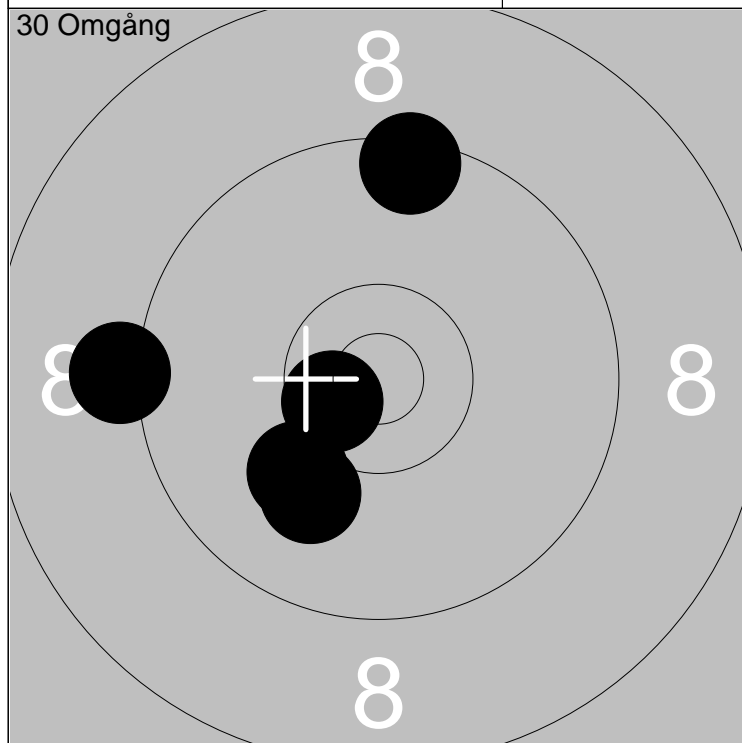

11: 9	←	Serie	48
12: *10	↙		
13: 10	↘		
14: 10	↘		
15: 9	↑		
Total		137	

16: *10	↓	Serie	45
17: 7	↙		
18: *10	↙		
19: 9	↓		
20: 9	↓		
Total		182	

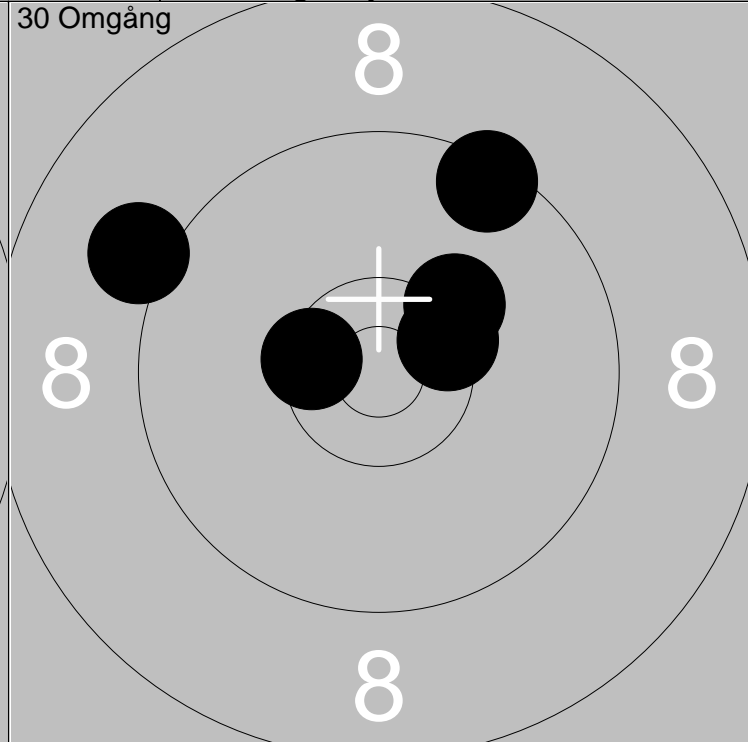
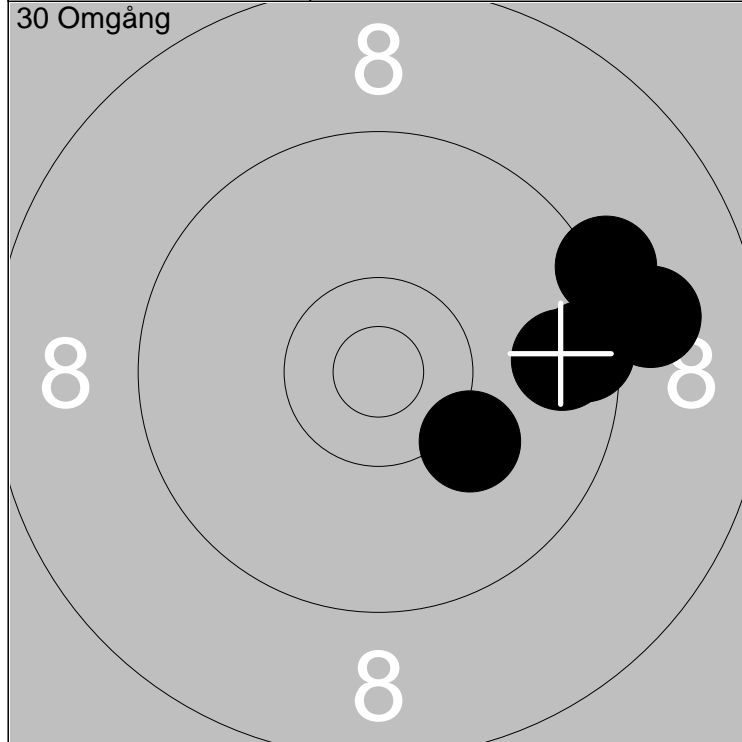

1: 9 →
2: 9 →
3: 9 →
4: 10 ↘
5: 9 ↗

Serie	46
Total	46

6: *10 ↗
7: *10 ←
8: 10 ↗
9: 9 ↗
10: 9 ←

Serie	48
Total	94

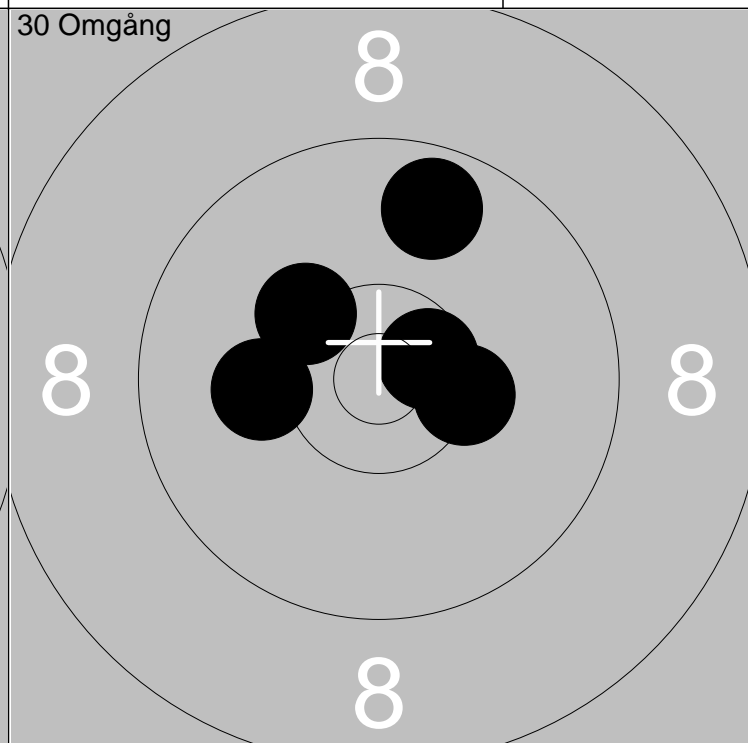
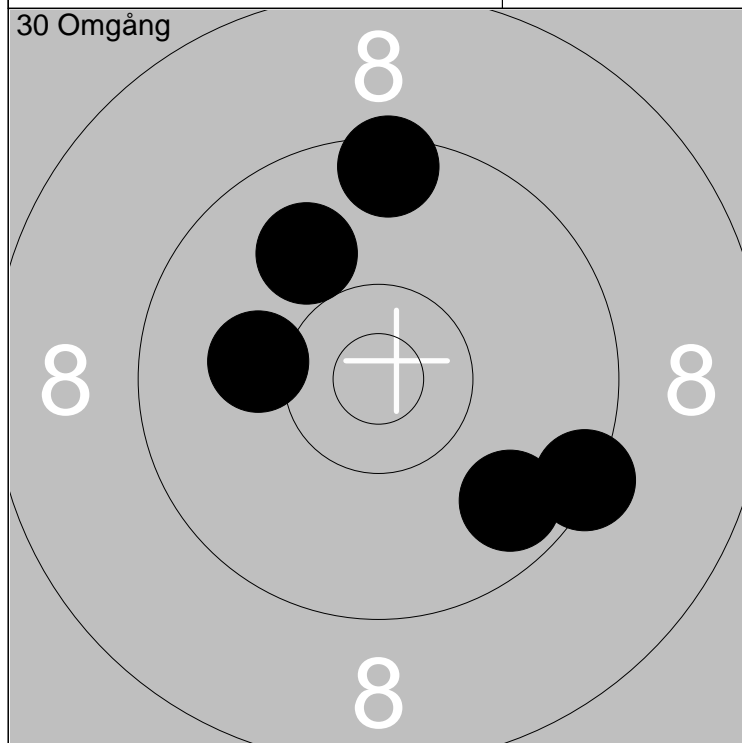

11: 10 ←
12: 9 ↘
13: 10 ↗
14: 9 ↘
15: 9 ↑

Serie	47
Total	141

16: 10 ↖
17: *10 →
18: 9 ↑
19: *10 →
20: 10 ←

Serie	49
Total	190

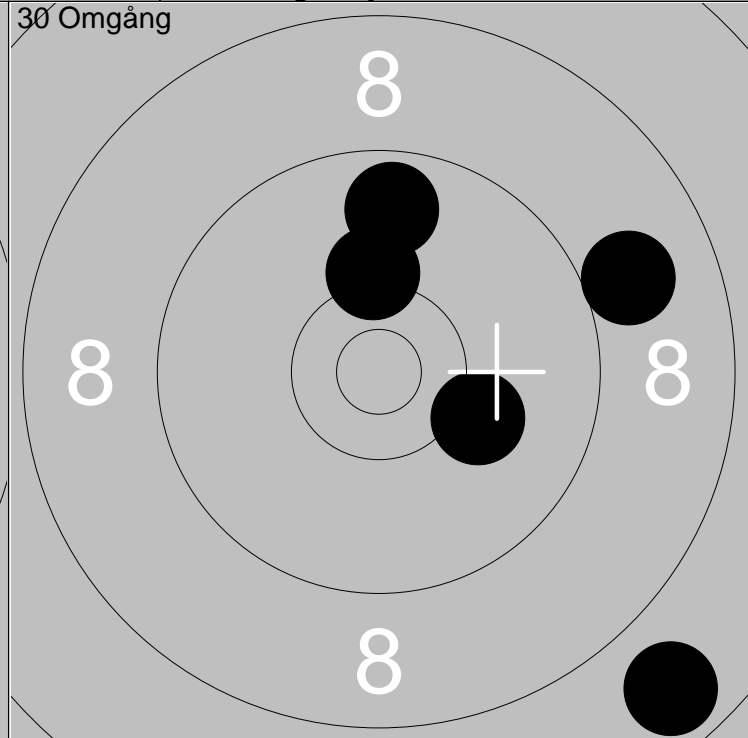
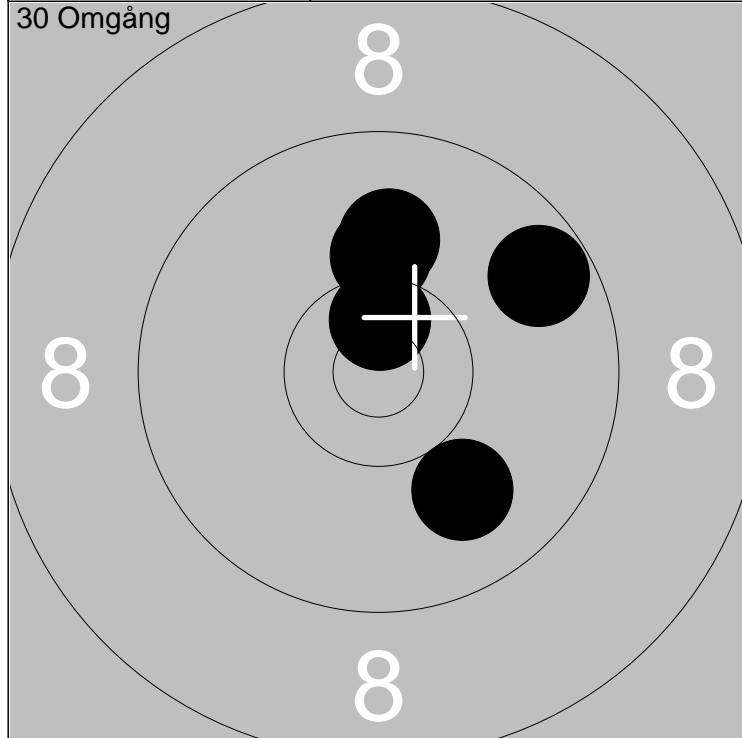

1: 9	↗
2: *10	↑
3: 10	↘
4: 10	↑
5: 10	↑

Serie	49
Total	49

6: 9	↗
7: 10	↑
8: 9	↑
9: 10	↘
10: 7	↘

Serie	45
Total	94

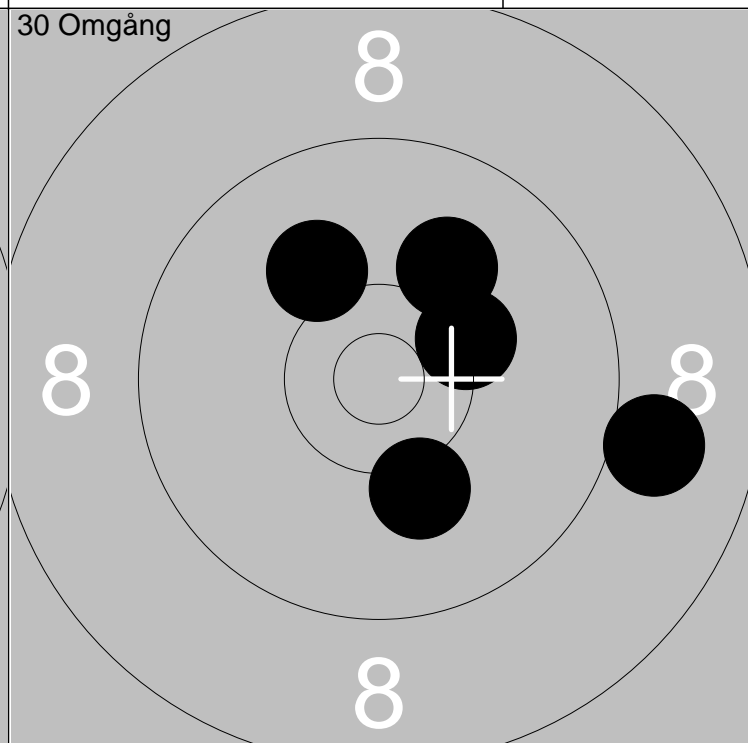
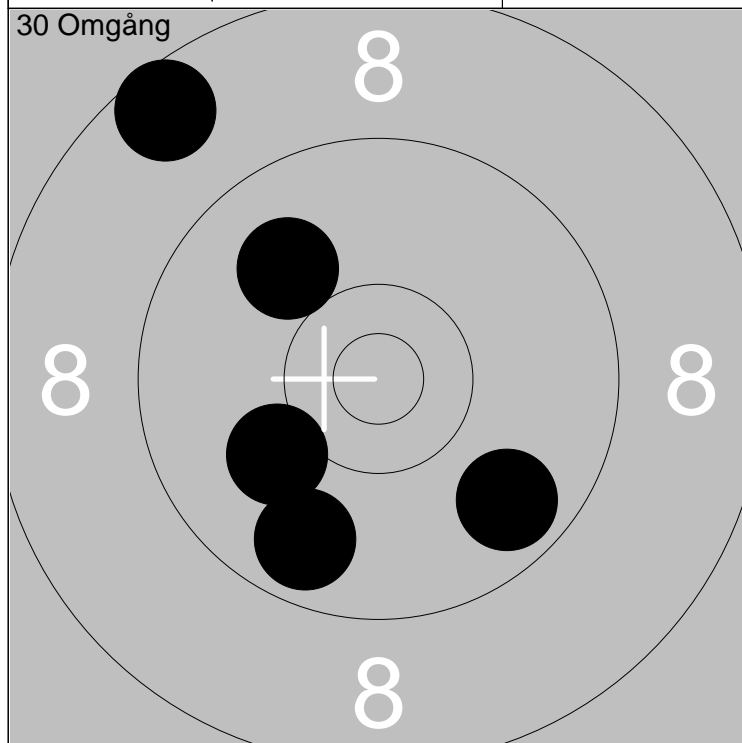

11: 9	↘
12: 10	↙
13: 9	↘
14: 10	↗
15: 8	↗

Serie	46
Total	140

16: 10	↘
17: 9	↘
18: *10	↗
19: 10	↗
20: 10	↖

Serie	49
Total	189

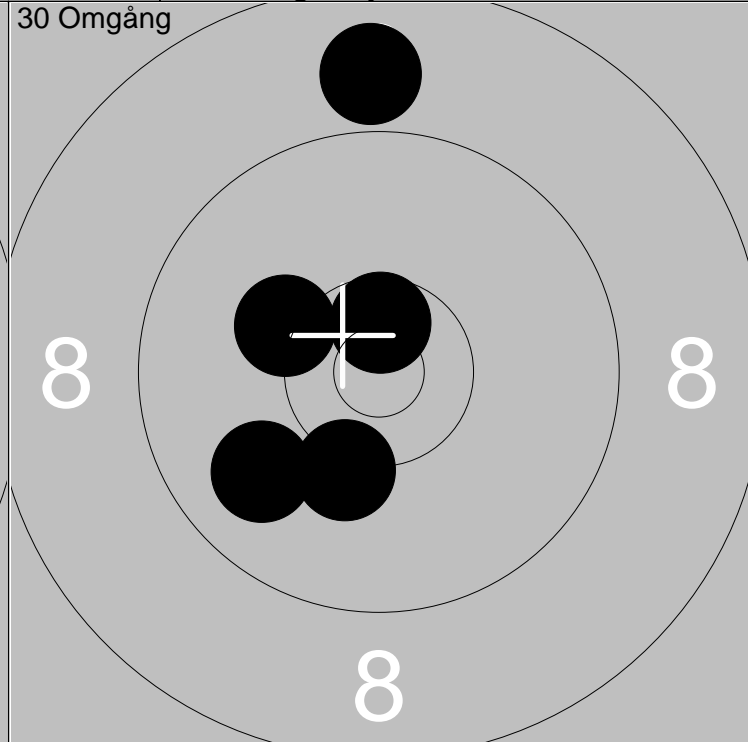
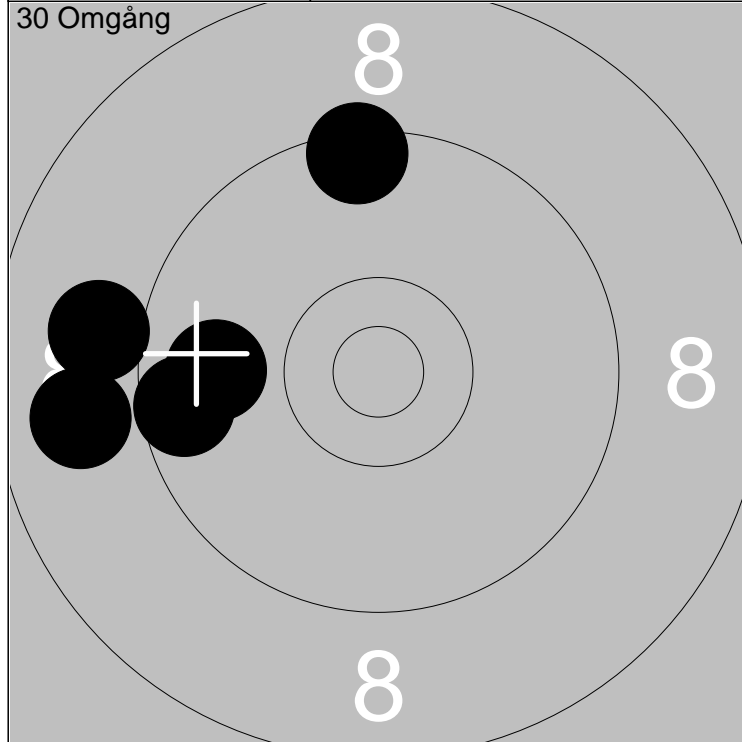

1: 8	←		Serie	44
2: 9	↑			
3: 9	←			
4: 9	←			
5: 9	←			
			Total	44

6: 9	↙		Serie	47
7: 10	↓			
8: 8	↑			
9: *10	↑			
10: 10	↖			
			Total	91

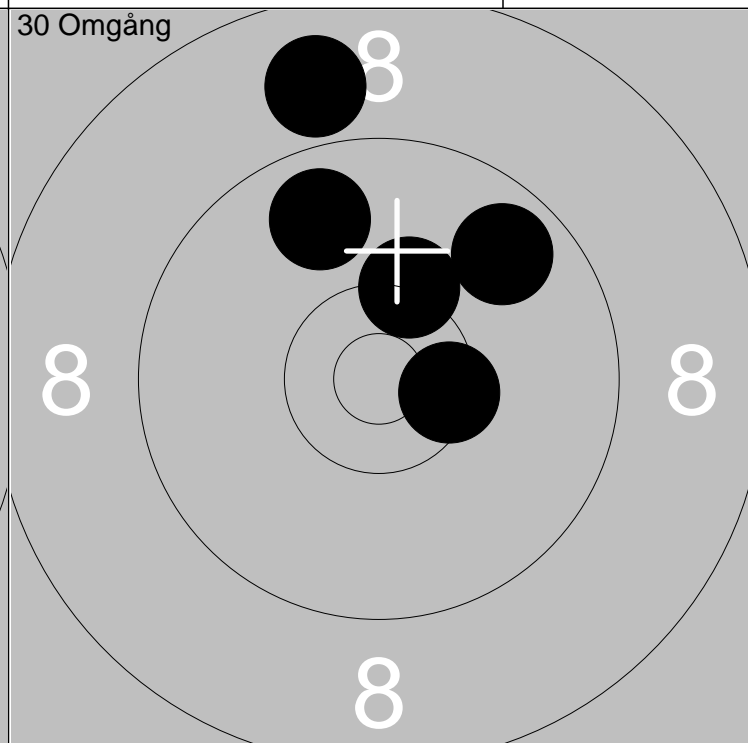
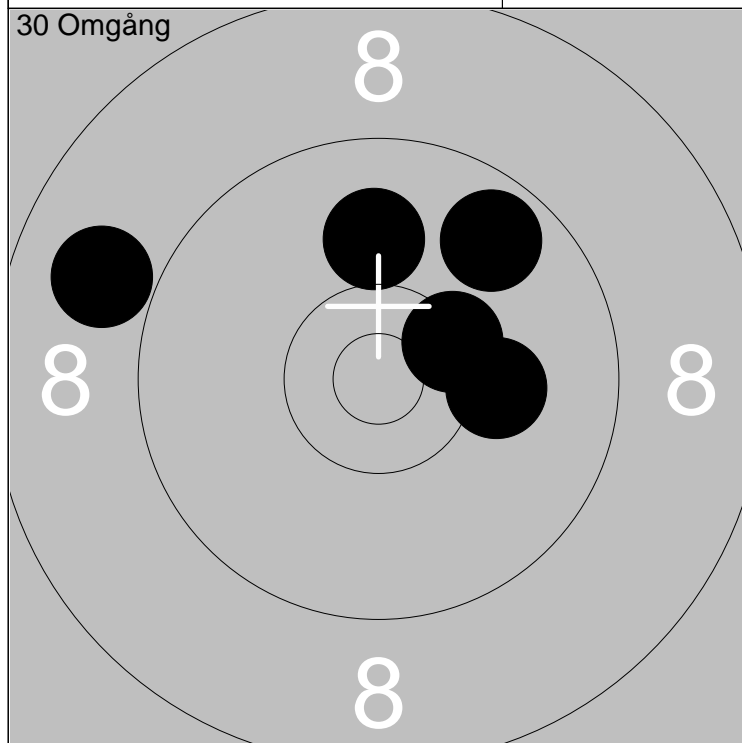

11: 8	↙		Serie	47
12: 10	↑			
13: 10	→			
14: 9	↗			
15: *10	↗			
			Total	138

16: *10	↑		Serie	46
17: *10	→			
18: 9	↑			
19: 9	↗			
20: 8	↑			
			Total	184

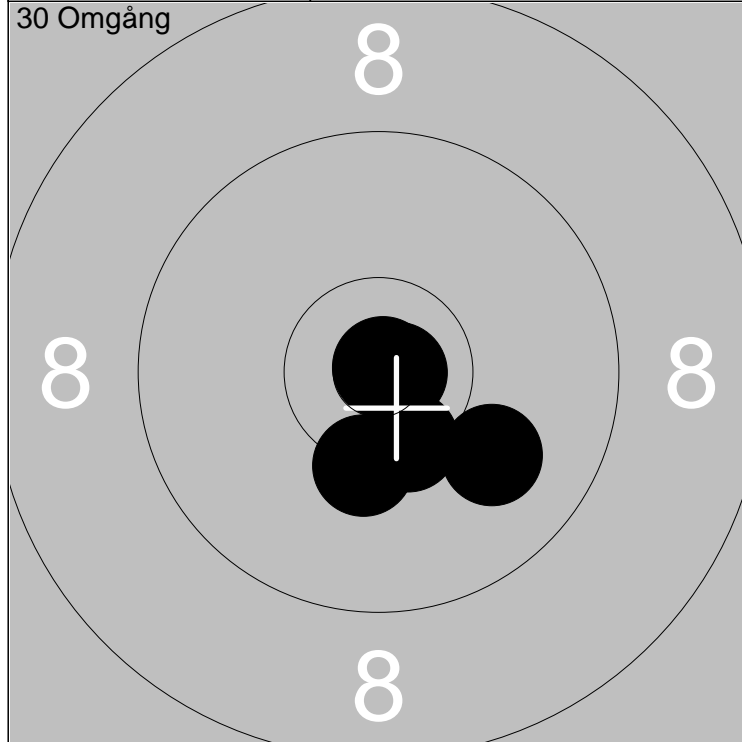

1:	↘
2:	→
3:	↙
4:	↗
5:	↘

Serie	52
Total	52

6:	↗
7:	↖
8:	↗
9:	↗
10:	→

Serie	47
Total	100

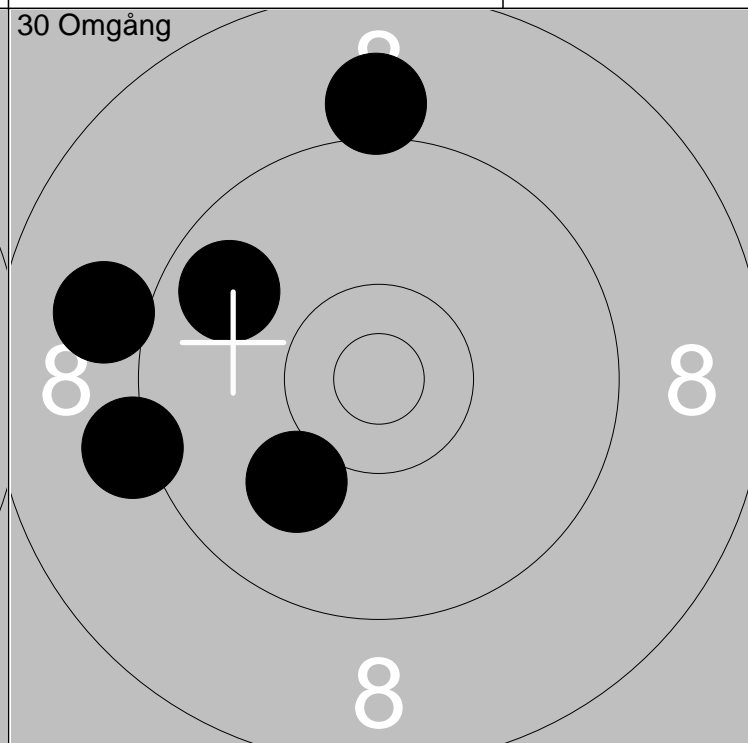
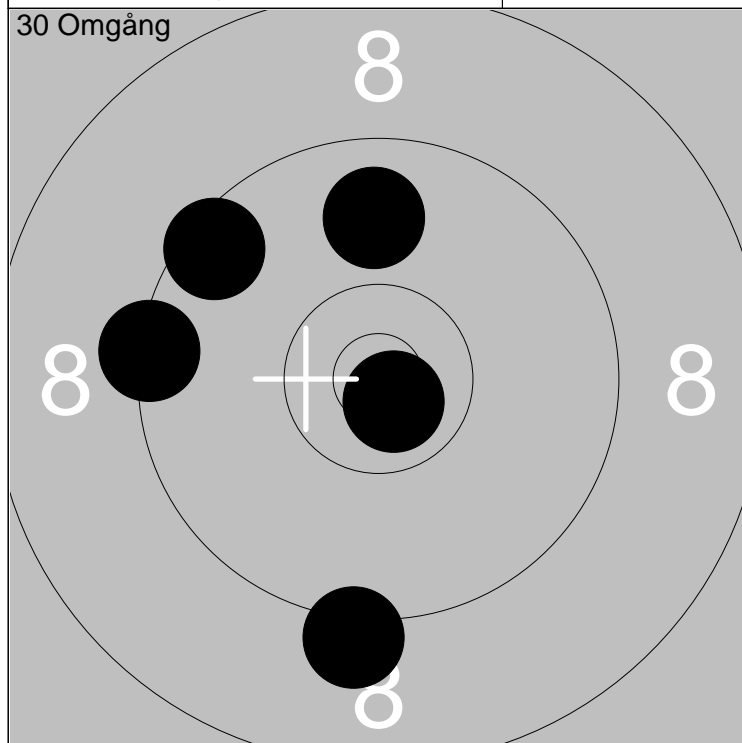

11:	↓
12:	←
13:	↙
14:	↗
15:	↑

Serie	48
Total	149

16:	←
17:	←
18:	↙
19:	↖
20:	↑

Serie	47
Total	196

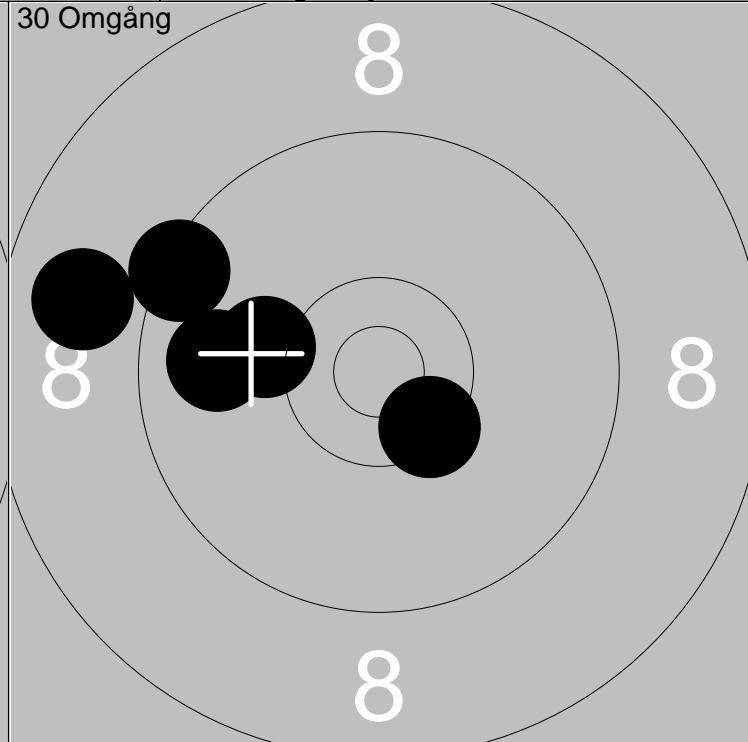
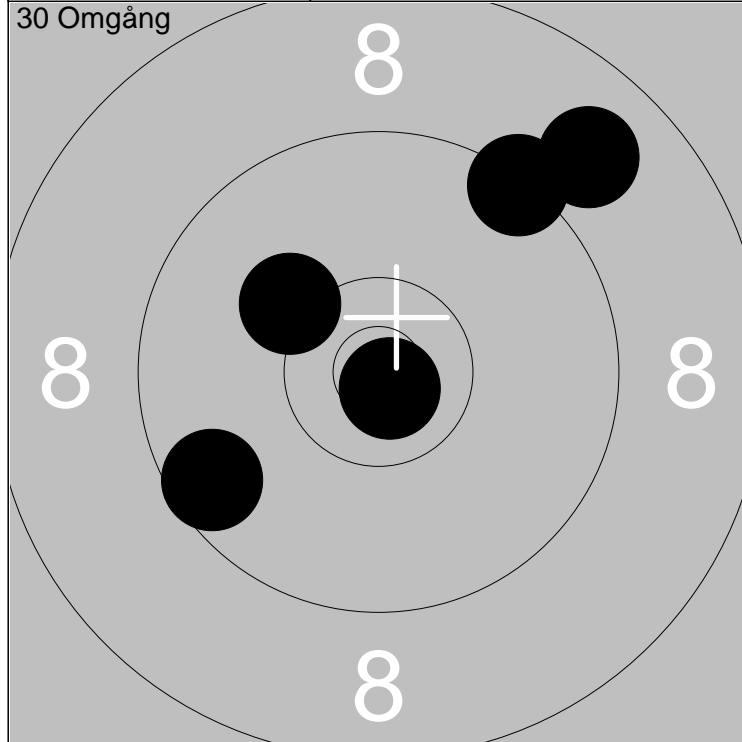

1: 9 ↗
2: 8 ↗
3: 10 ↖
4: *10 ↓
5: 9 ↙

Serie	46
Total	46

6: 9 ↗
7: 8 ↖
8: *10 ↓
9: 9 ↖
10: 10 ↖

Serie	46
Total	92

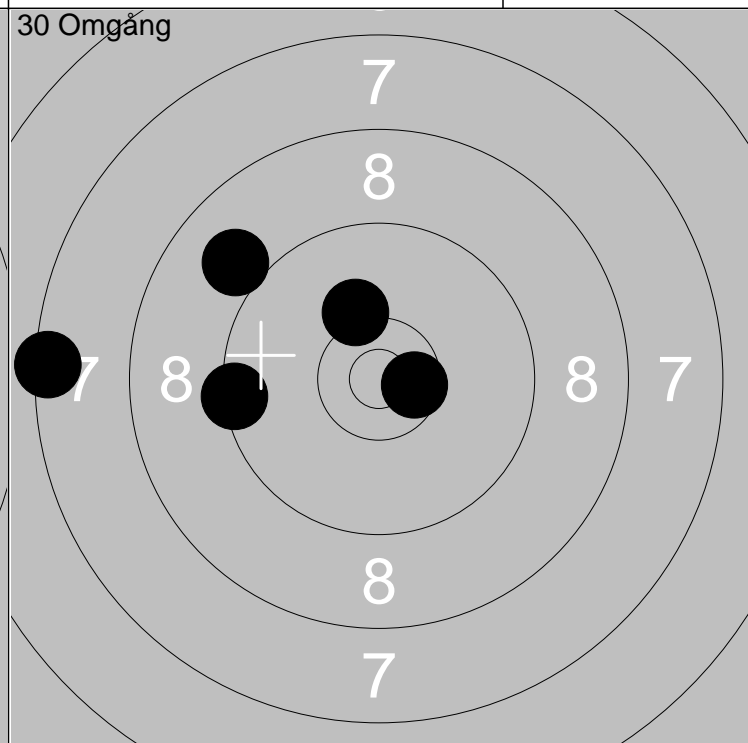
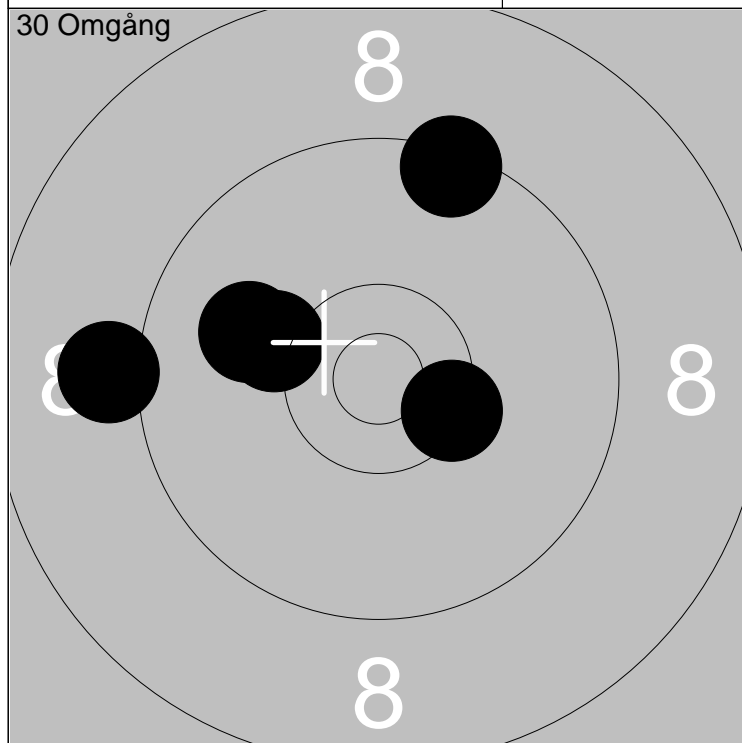

11: 10 ↖
12: 9 ↖
13: 9 ↗
14: 10 ↖
15: *10 →

Serie	48
Total	140

16: 10 ↗
17: 9 ↗
18: *10 →
19: 7 ↖
20: 9 ↖

Serie	45
Total	185

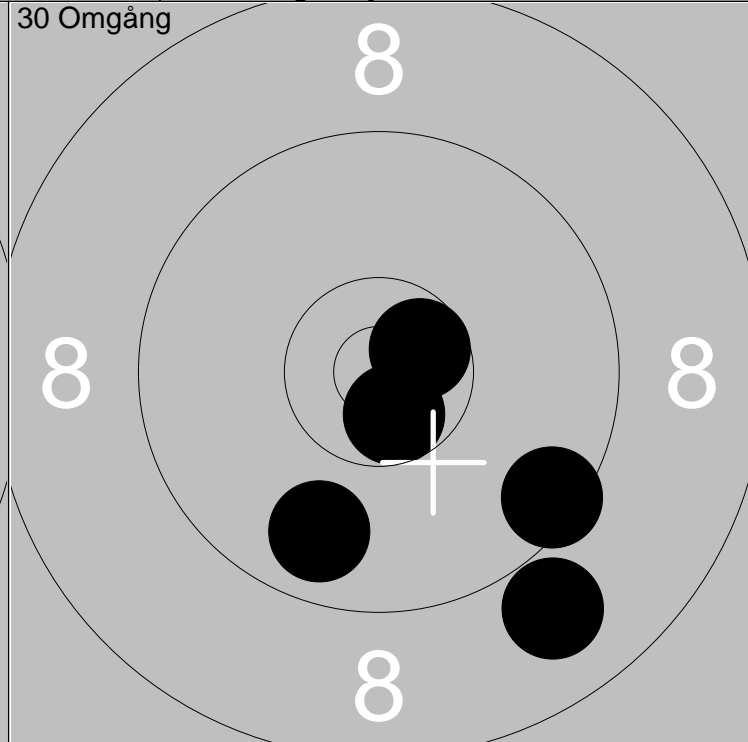
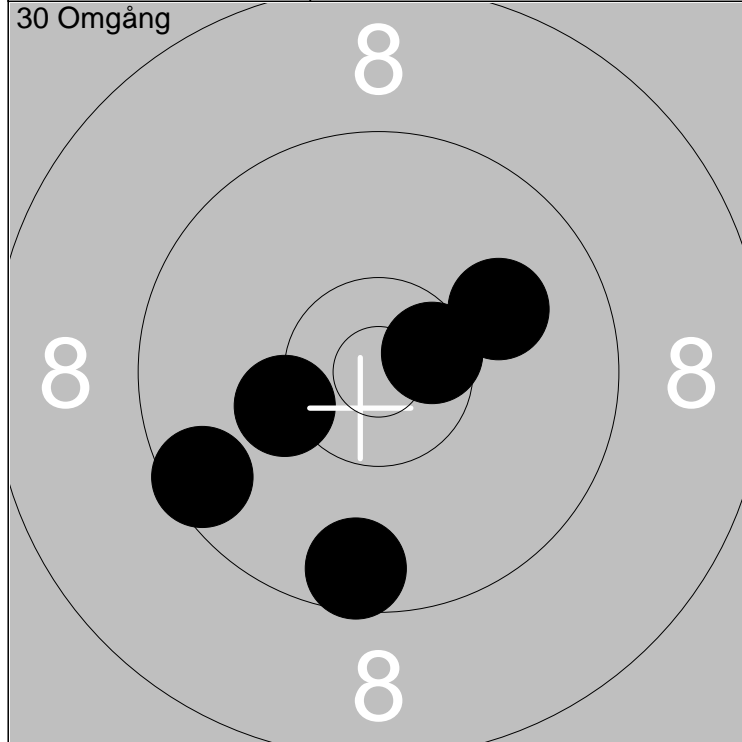

1: 10 ←	Serie	48	6: 8 ↓	Serie	46
2: 9 ←			7: 9 ↓		
3: *10 →	Total	48	8: *10 ↓	Total	94
4: 10 ↗			9: *10 ↗		
5: 9 ↓			10: 9 ↓		

6: 8 ↓	Serie	46	7: 9 ↓	Serie	46
8: *10 ↓			9: *10 ↗		
9: *10 ↗	Total	94	10: 9 ↓	Total	94
10: 9 ↓					

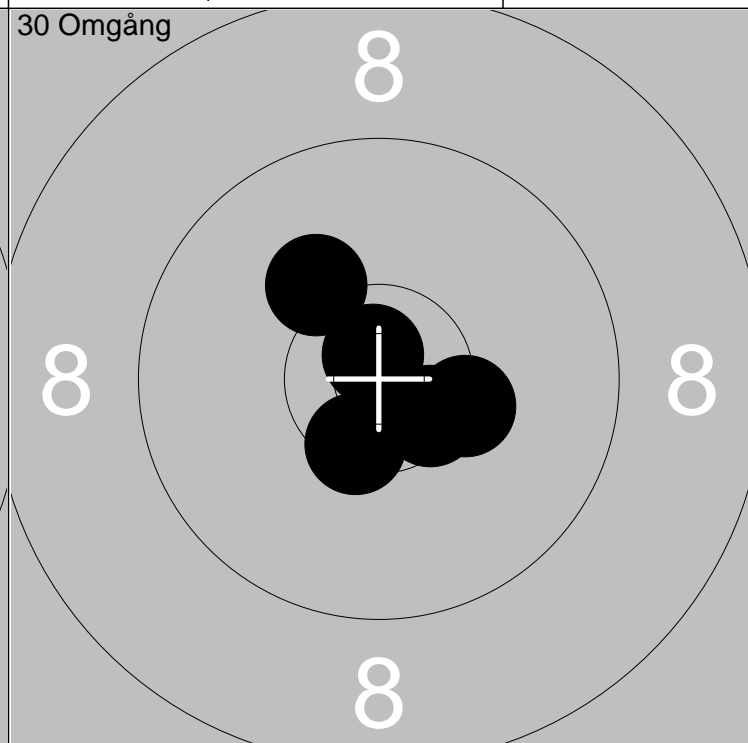
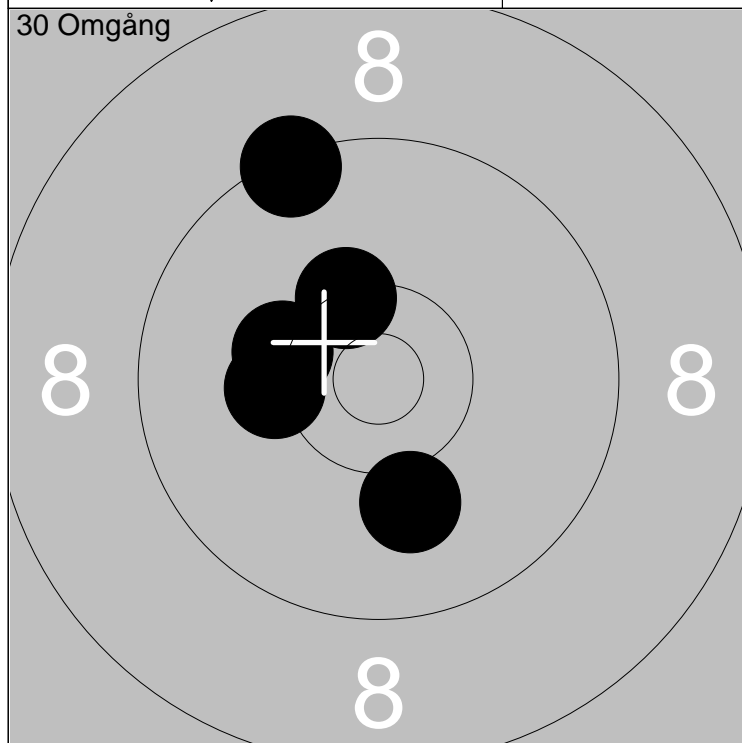

11: 10 ←	Serie	49	16: *10 →	Serie	50
12: *10 ↗			17: *10 ↓		
13: 10 ↓	Total	143	18: *10 ↓	Total	193
14: 10 ←			19: *10 ↑		
15: 9 ↗			20: 10 ↗		

16: *10 →	Serie	50	17: *10 ↓	Serie	50
18: *10 ↓			19: *10 ↑		
19: *10 ↑	Total	193	20: 10 ↗	Total	193
20: 10 ↗					

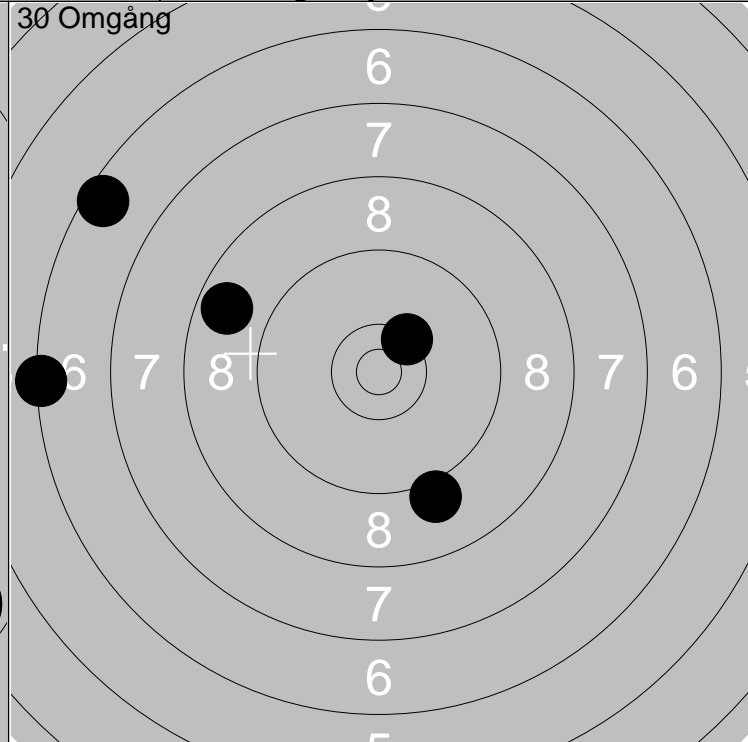
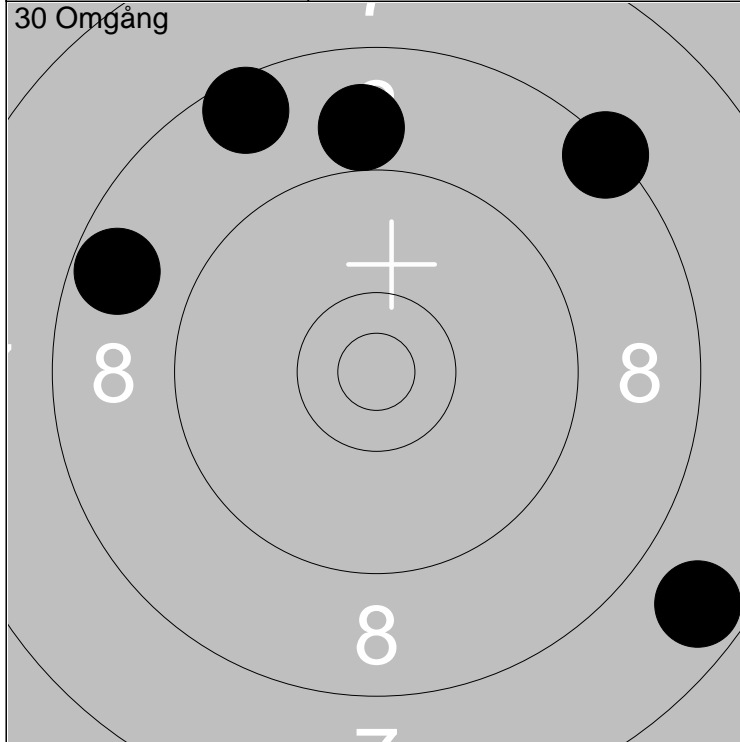

1: 8	↖		Serie	39
2: 8	↗			
3: 8	↑			
4: 7	↘			
5: 8	↖			
			Total	39

6: *10	↗		Serie	39
7: 9	↘			
8: 8	↖			
9: 6	↗			
10: 6	←			
			Total	78

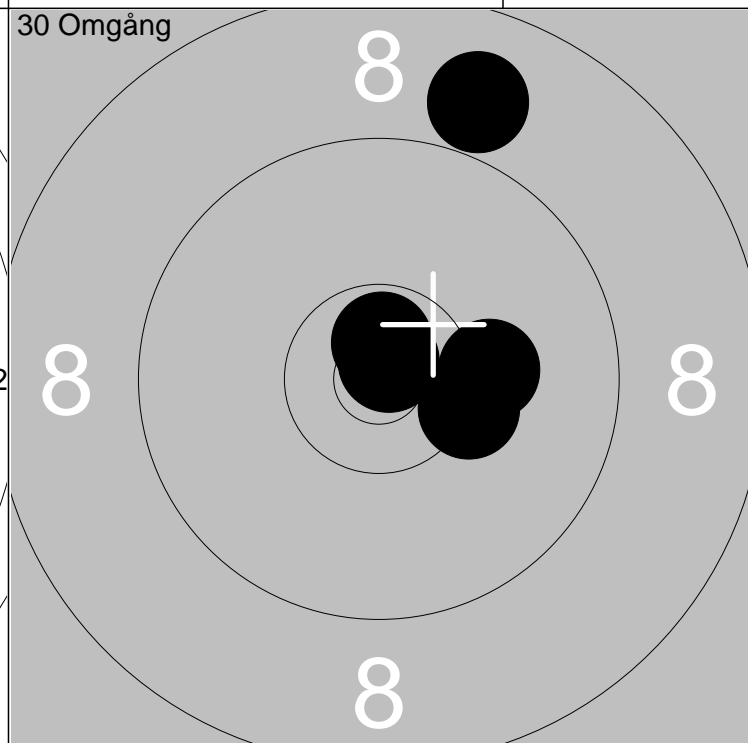
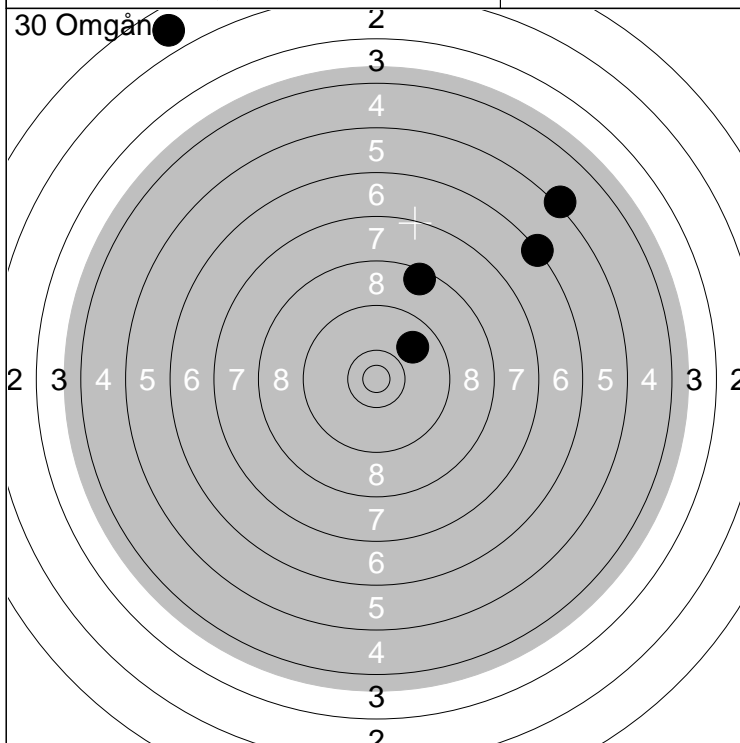

11: 1	↖		Serie	29
12: 5	↗			
13: 6	↗			
14: 8	↑			
15: 9	↗			
			Total	107

16: *10	↑		Serie	48
17: 8	↑			
18: *10	↗			
19: *10	→			
20: 10	→			
			Total	155

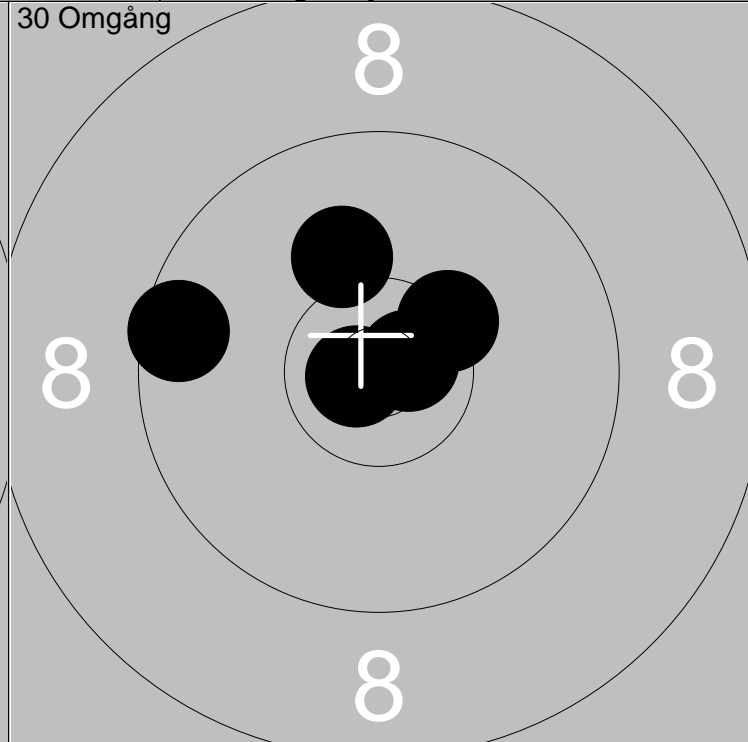
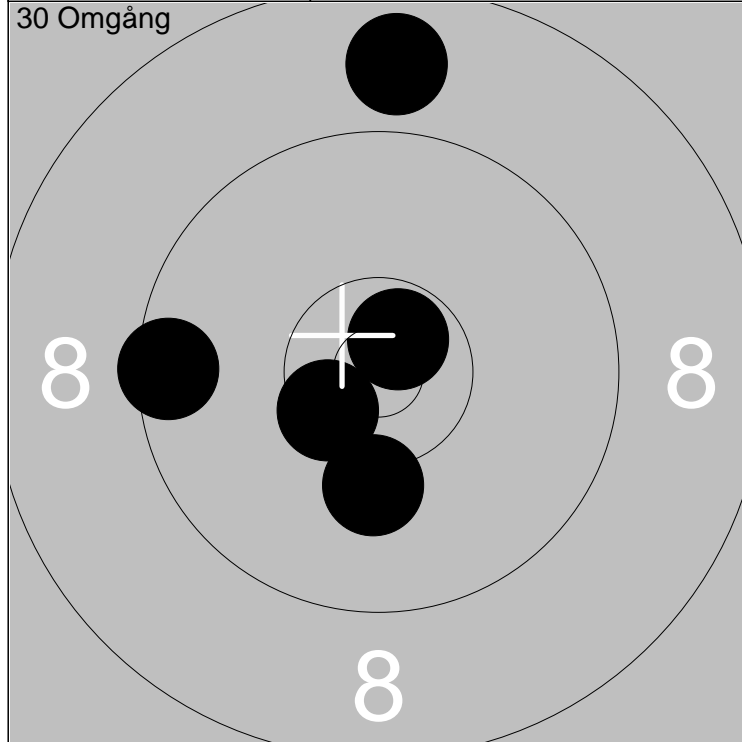

1: 10	↓
2: *10	↙
3: *10	↗
4: 8	↑
5: 9	←

Serie	47
Total	47

6: 10	↑
7: *10	←
8: *10	↗
9: *10	↘
10: 9	←

Serie	49
Total	96

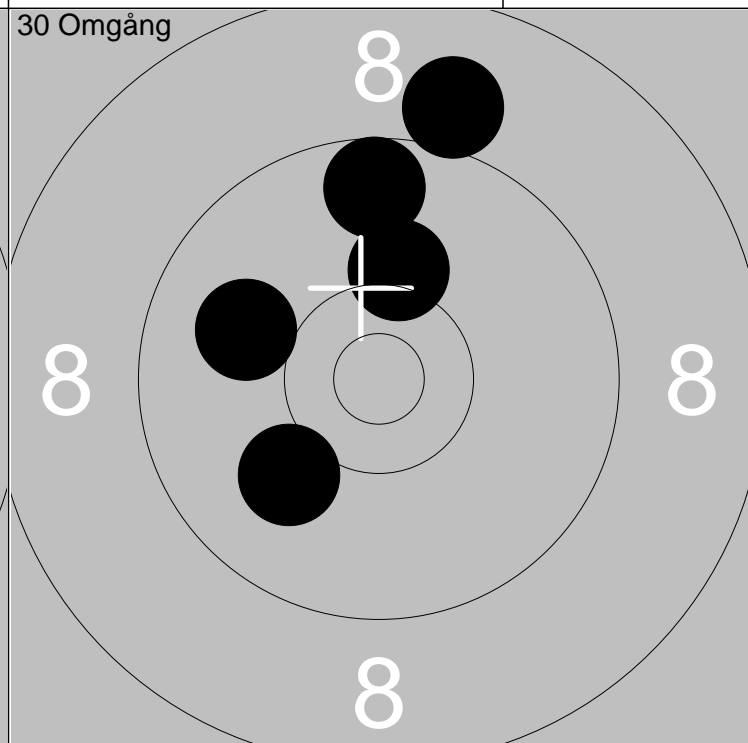
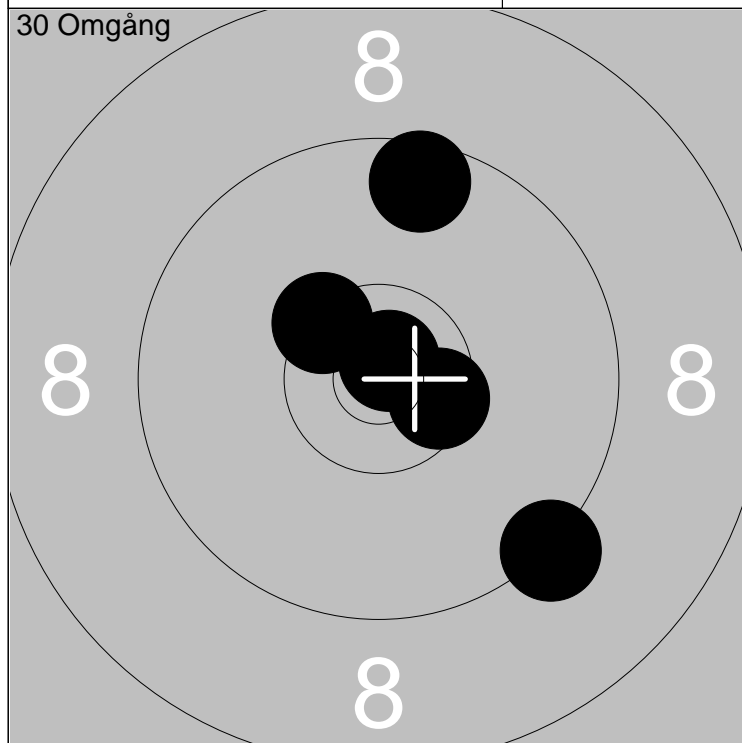

11: *10	↖
12: *10	↗
13: 9	↑
14: 9	↓
15: *10	↘

Serie	48
Total	144

16: 10	↙
17: 10	←
18: 10	↑
19: 9	↑
20: 9	↑

Serie	48
Total	192

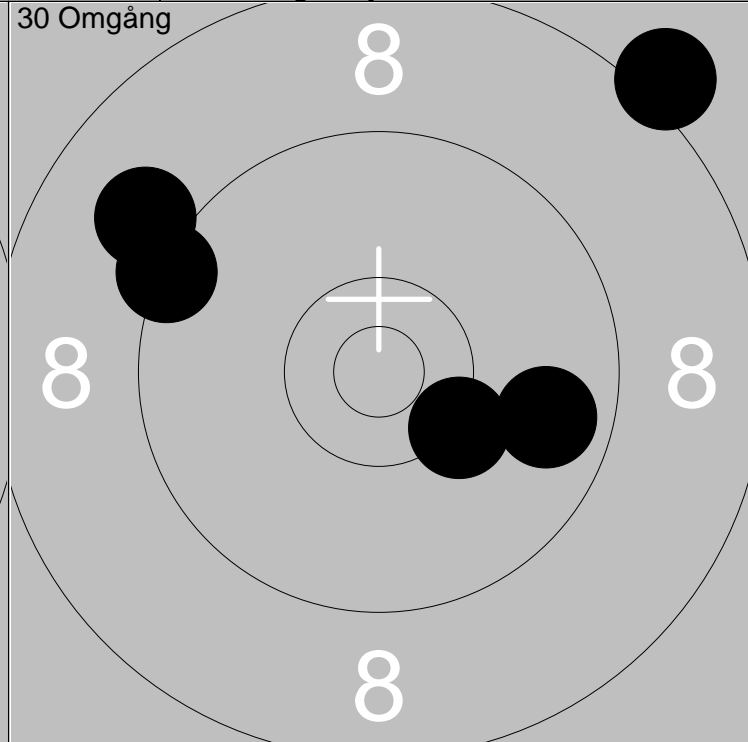
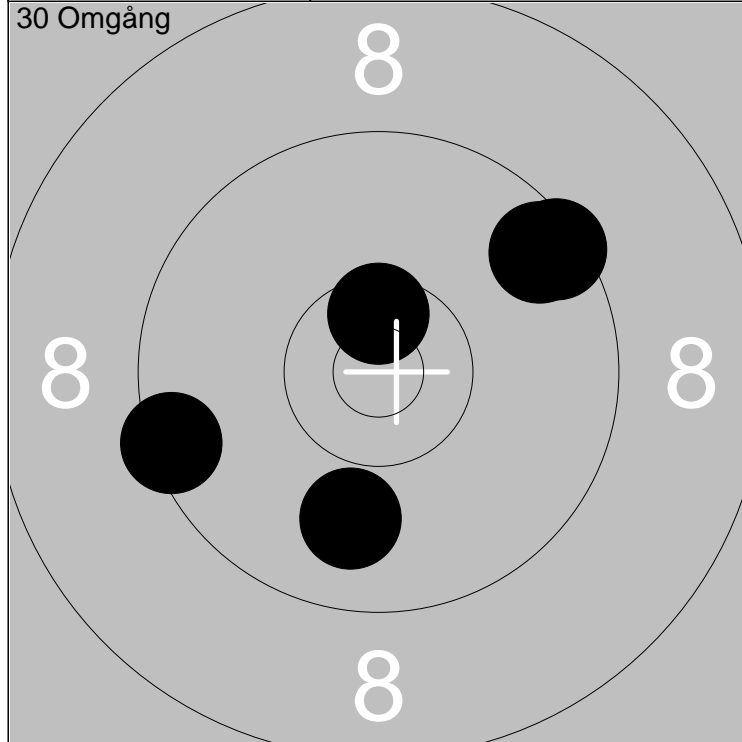

1: 9 ←	Serie	46
2: 9 ↓		
3: 9 ↗	Total	46
4: 9 ↗		
5: *10 ↑		

6: 9 →	Serie	45
7: 9 ↗		
8: 10 ↓	Total	91
9: 8 ↗		
10: 9 ↖		

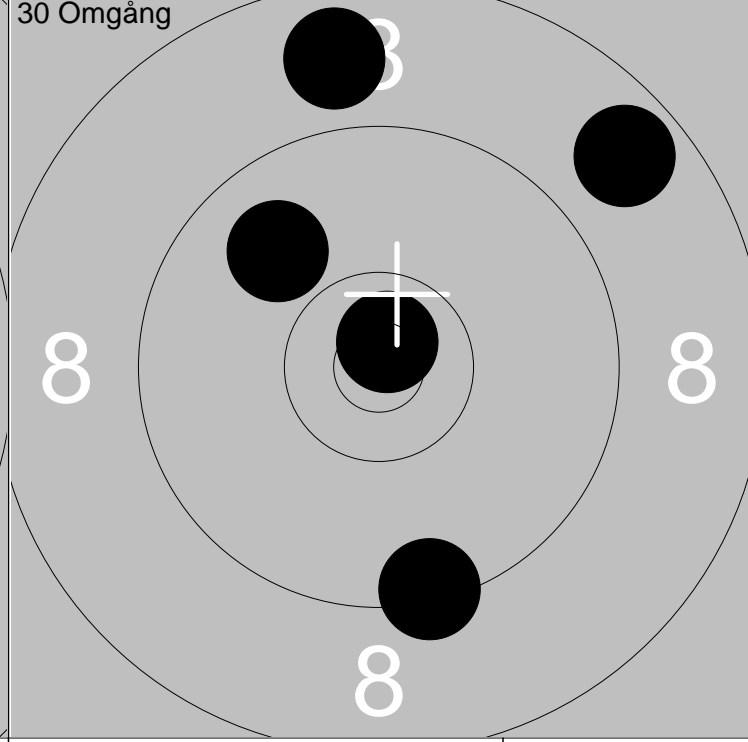
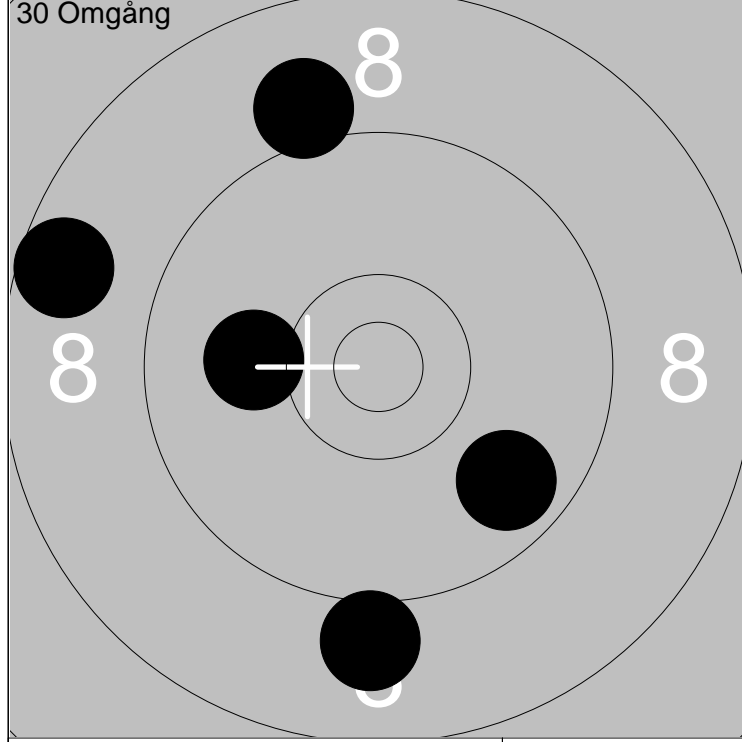

11: 10 ←	Serie	45
12: 9 ↗		
13: 8 ↖	Total	136
14: 9 ↓		
15: 9 ↓		

16: 9 ↓	Serie	44
17: 9 ↗		
18: *10 ↑	Total	180
19: 8 ↑		
20: 8 ↗		

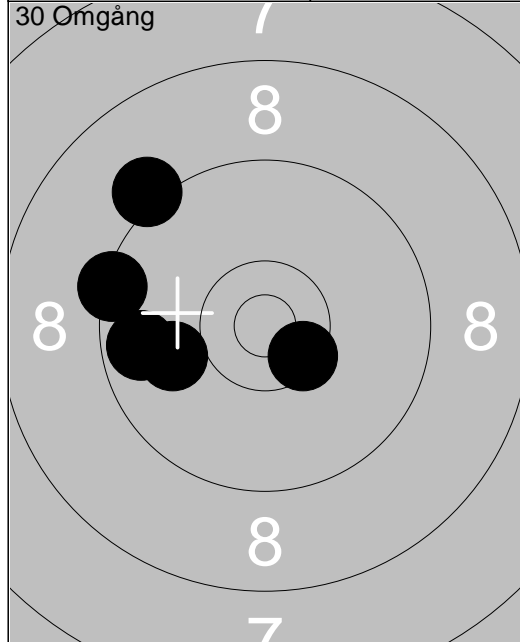

1: 9 ↗
2: 9 ←
3: 9 ←
4: *10 ↘
5: 10 ←
Serie 47
Total 47

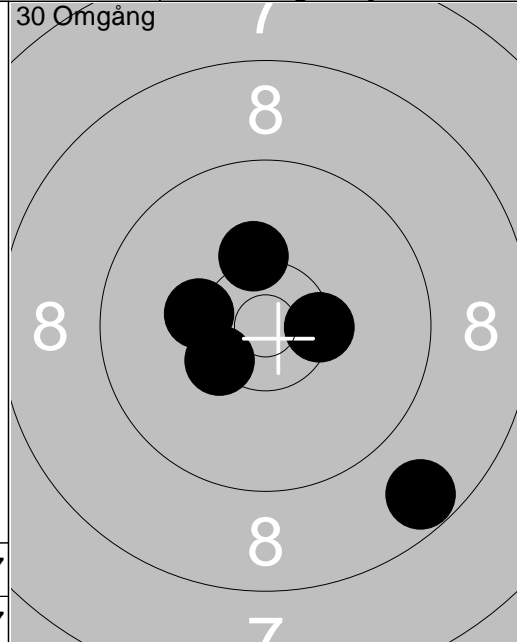

6: 10 ←
7: *10 ↙
8: *10 →
9: 8 ↘
10: 10 ↑
Serie 48
Total 95

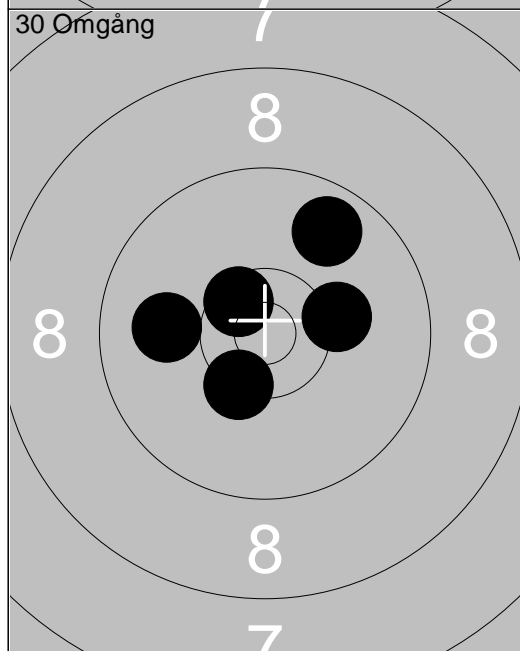

11: *10 ↘
12: 9 ↗
13: 10 ←
14: *10 ↗
15: 10 →
Serie 49
Total 144

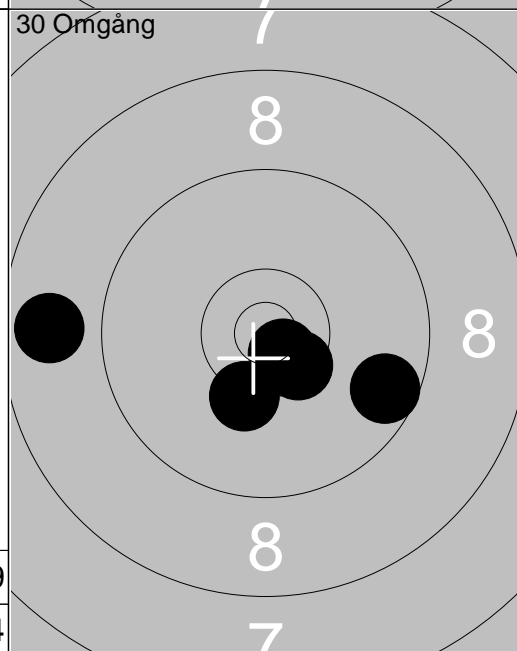

16: 10 ↘
17: 9 →
18: *10 ↘
19: 8 ←
20: *10 ↘
Serie 47
Total 191

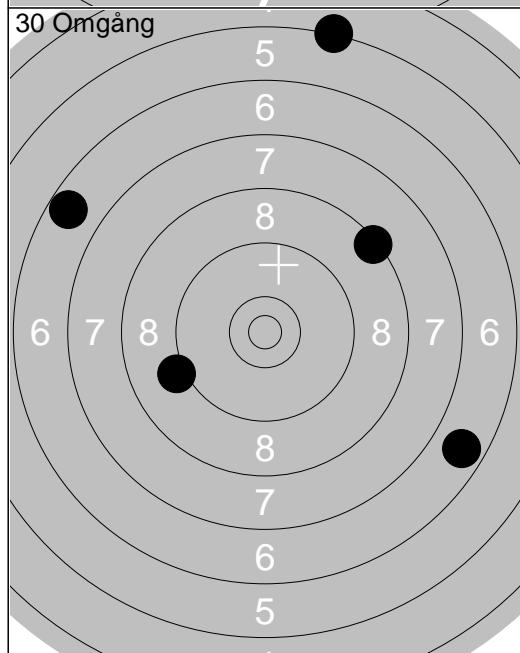

21: 6 ←
22: 9 ←
23: 5 ↑
24: 6 →
25: 8 ↗
Serie 34
Total 225

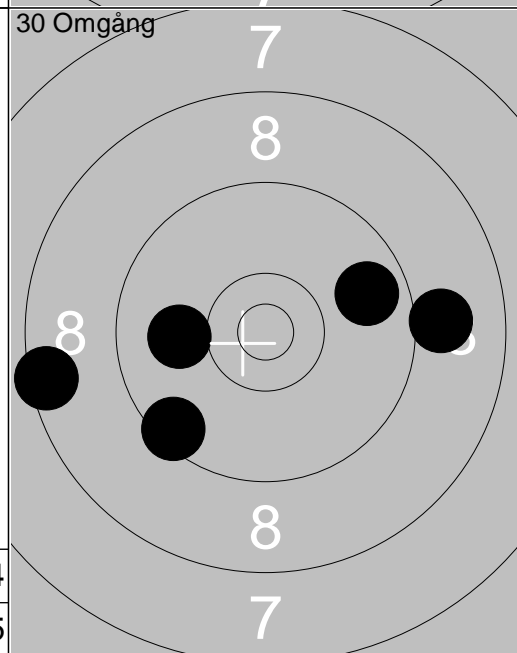

26: 9 ↙
27: 8 ←
28: 9 →
29: 9 →
30: 10 ←
Serie 45
Total 270

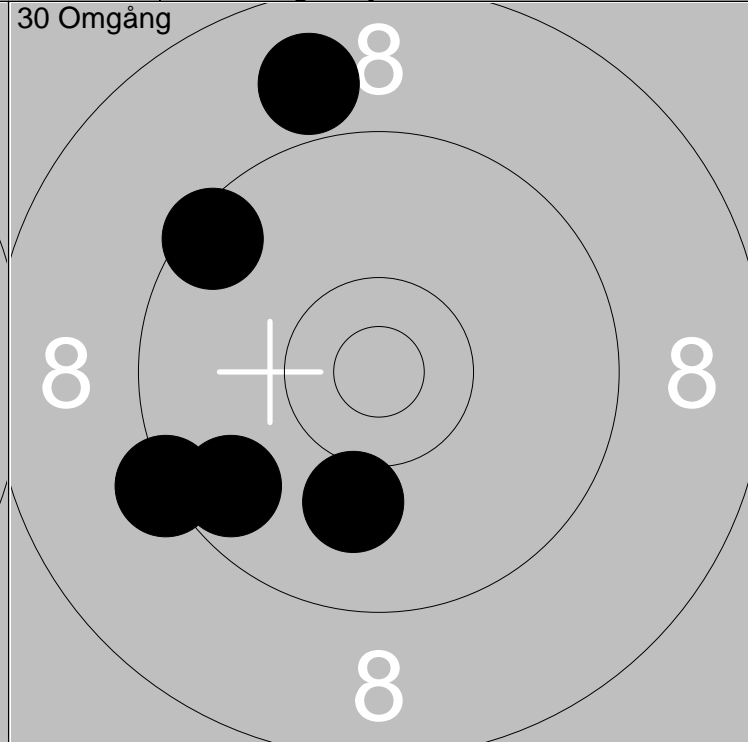
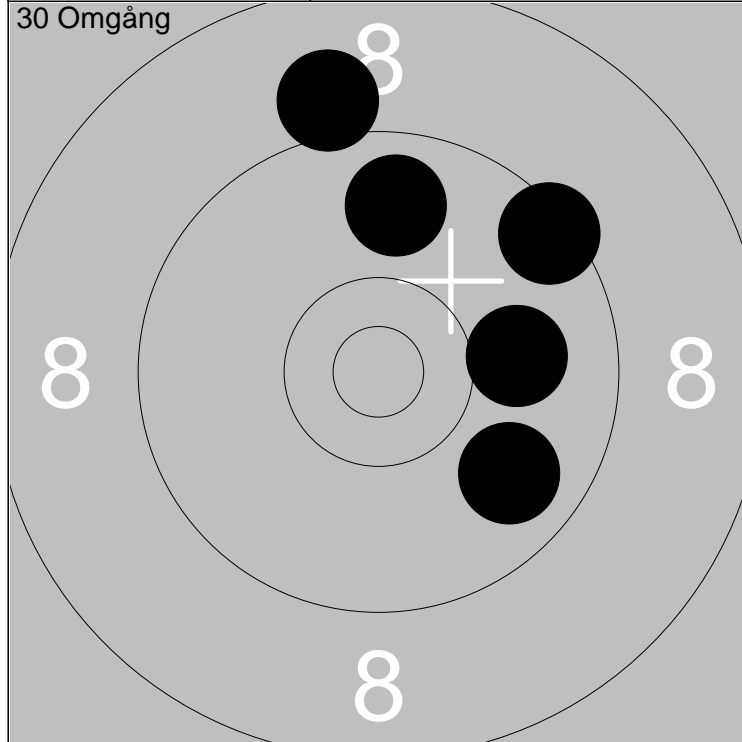

1: 9	↑
2: 9	↑
3: 9	↗
4: 10	→
5: 9	↘

Serie	46
Total	46

6: 10	↓
7: 9	↖
8: 9	↖
9: 8	↑
10: 9	↖

Serie	45
Total	91

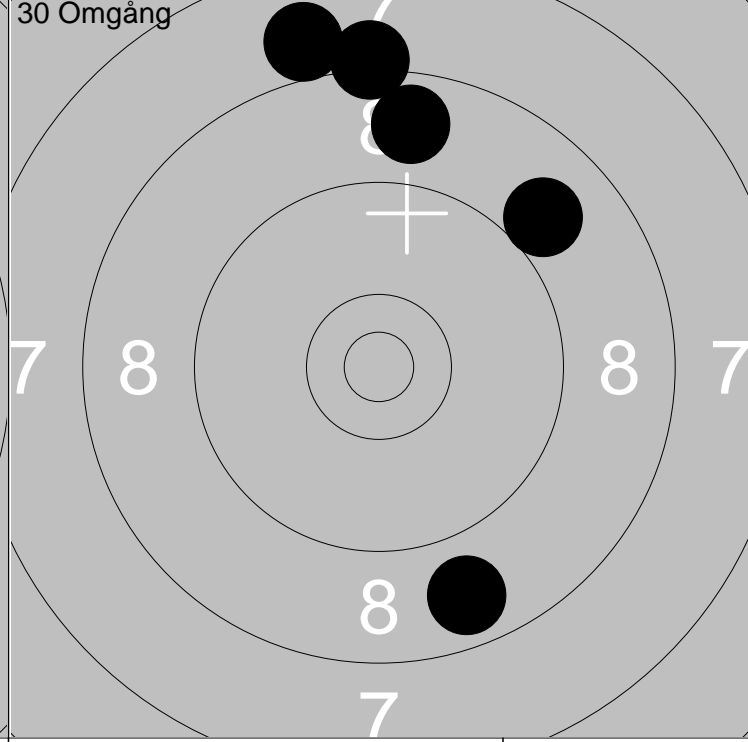
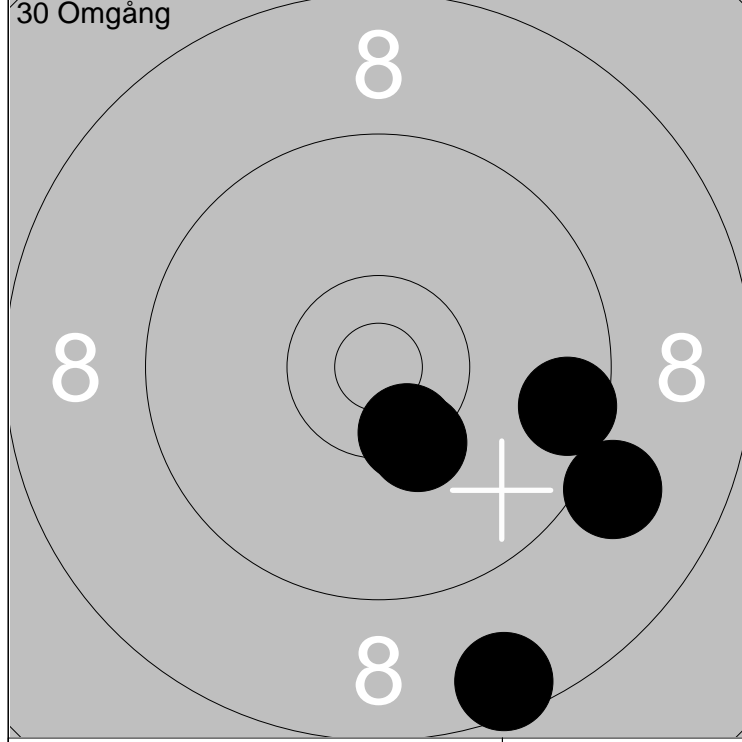

11: 8	↙
12: *10	↙
13: 9	→
14: *10	↙
15: 9	↘

Serie	46
Total	137

16: 8	↑
17: 9	↗
18: 8	↑
19: 8	↓
20: 8	↑

Serie	41
Total	178

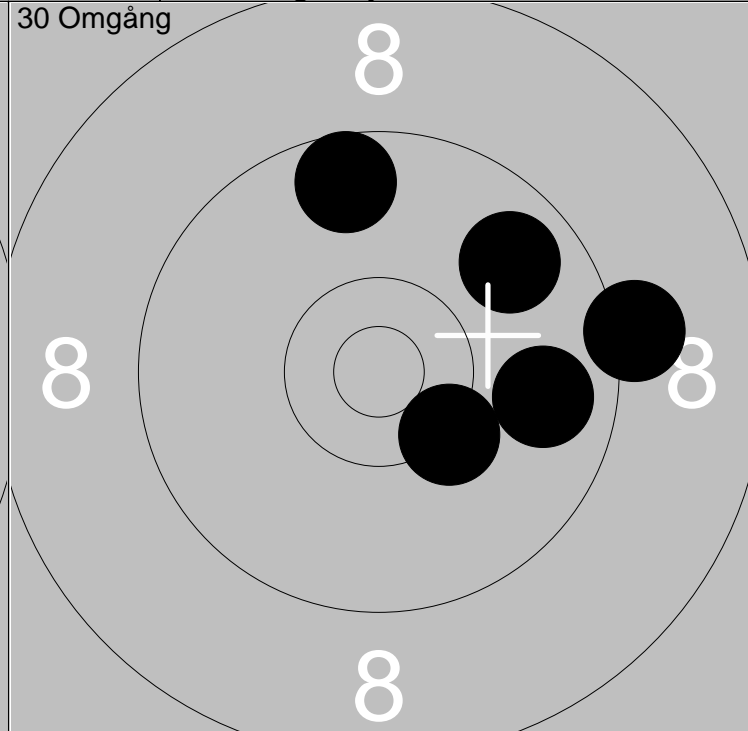

1: 9 ←	Serie	48
2: *10 ↑		
3: *10 ↑	Total	48
4: 9 ↗		
5: 10 ↓		

6: 9 ↑	Serie	46
7: *10 ↘		
8: 9 →	Total	94
9: 9 ↗		
10: 9 →		

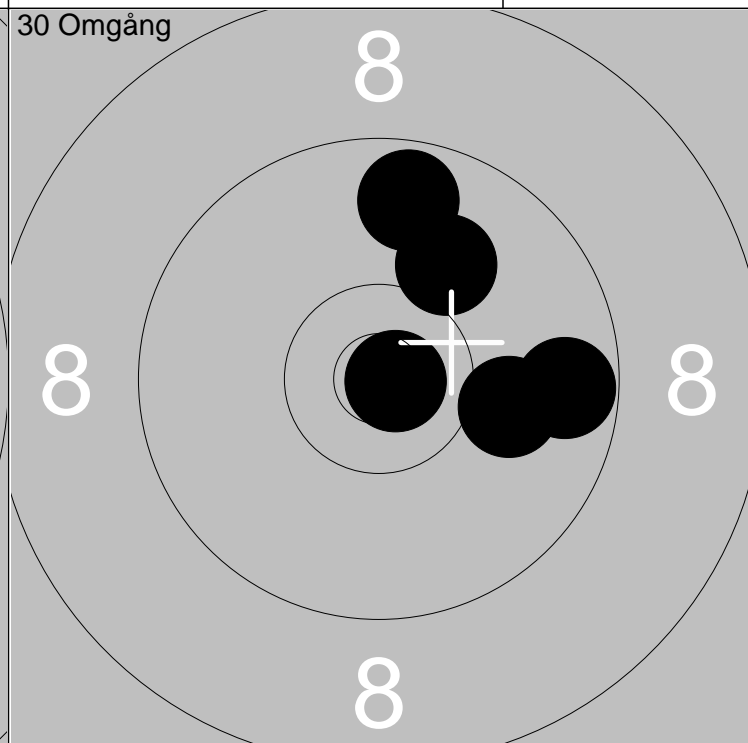
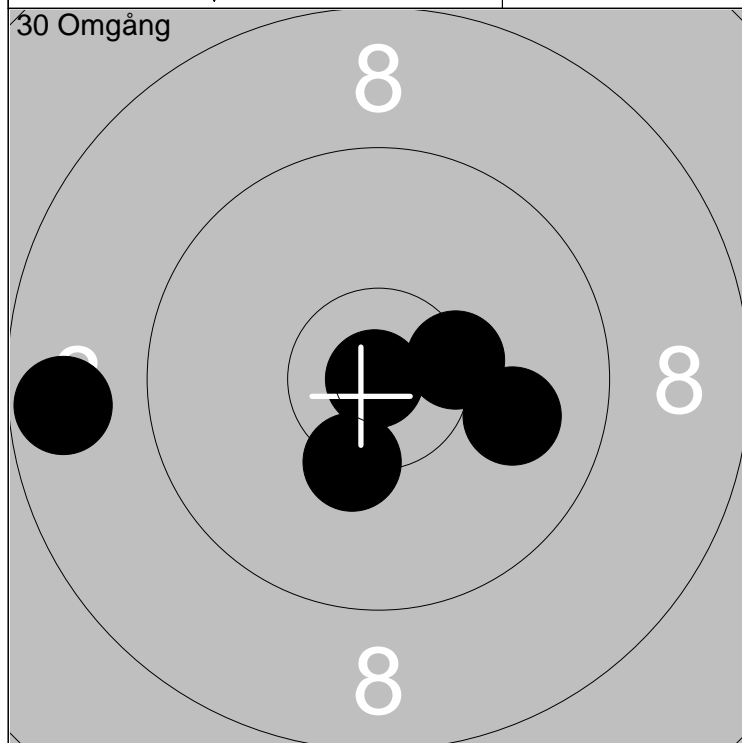

11: *10 ←	Serie	48
12: *10 ↓		
13: 10 →	Total	142
14: *10 →		
15: 8 ←		

16: 10 ↗	Serie	48
17: 10 →		
18: 9 →	Total	190
19: *10 →		
20: 9 ↑		

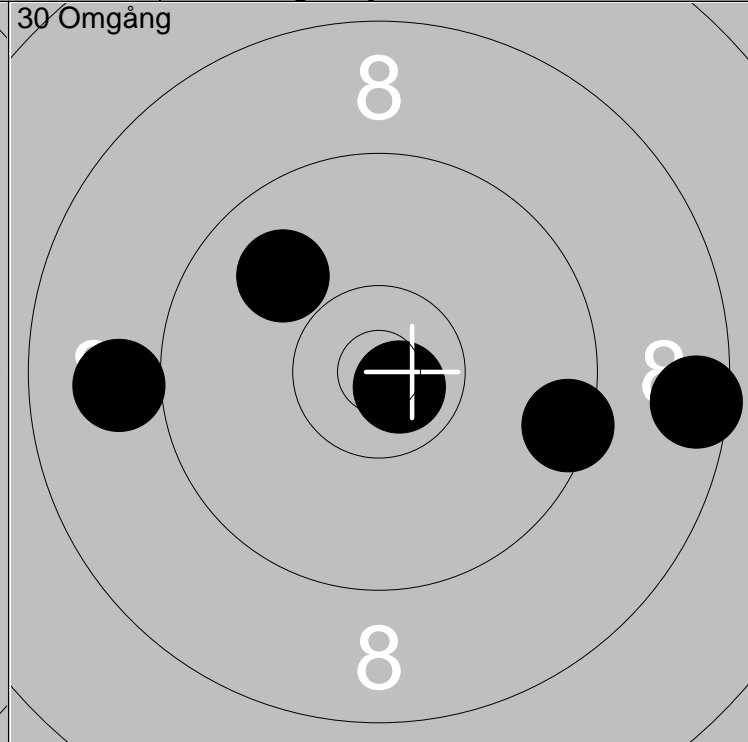
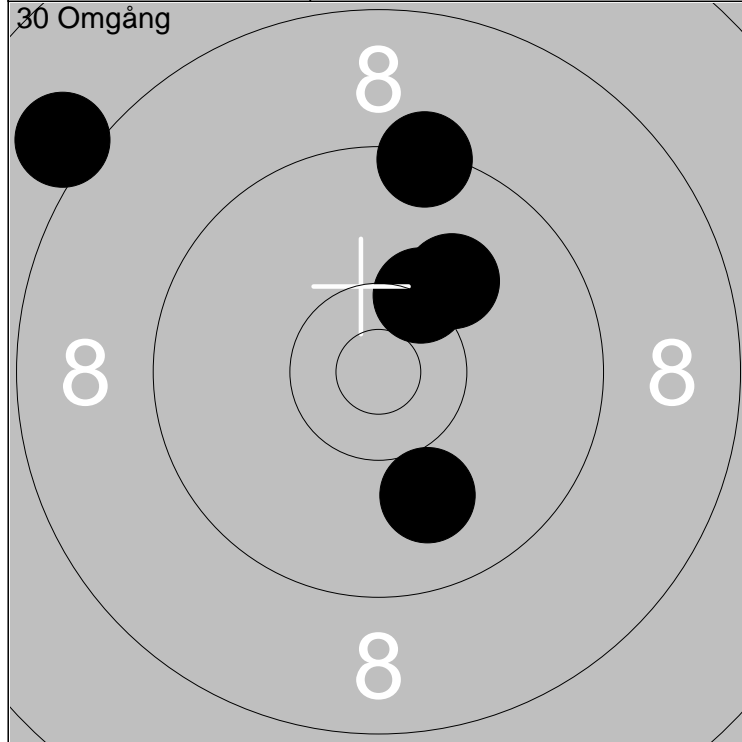

1: 9	↑		Serie	47
2: 10	↓			
3: 10	↗			
4: 8	↖			
5: *10	↑			
			Total	47

6: 9	↗		Serie	45
7: 8	→			
8: 9	←			
9: *10	↓			
10: 9	→			
			Total	92

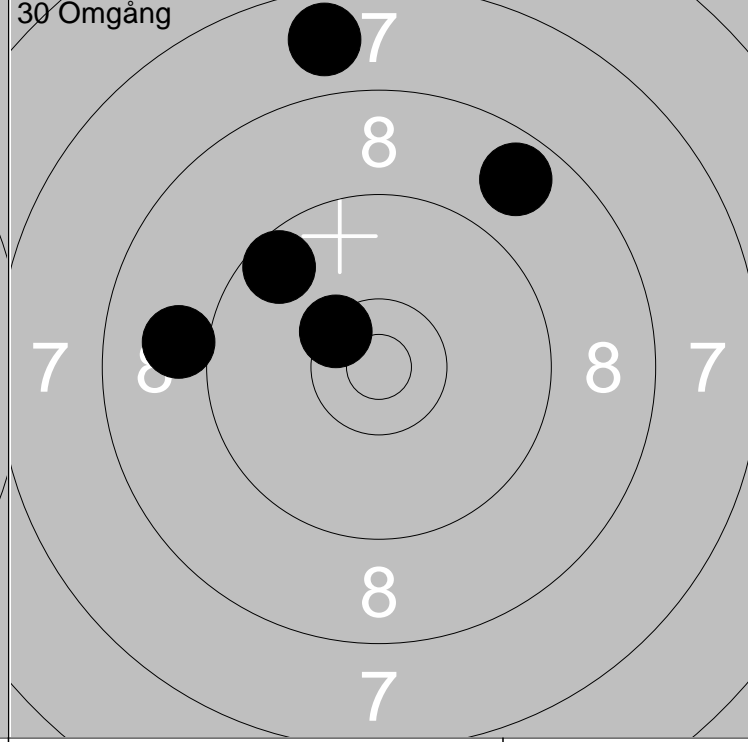
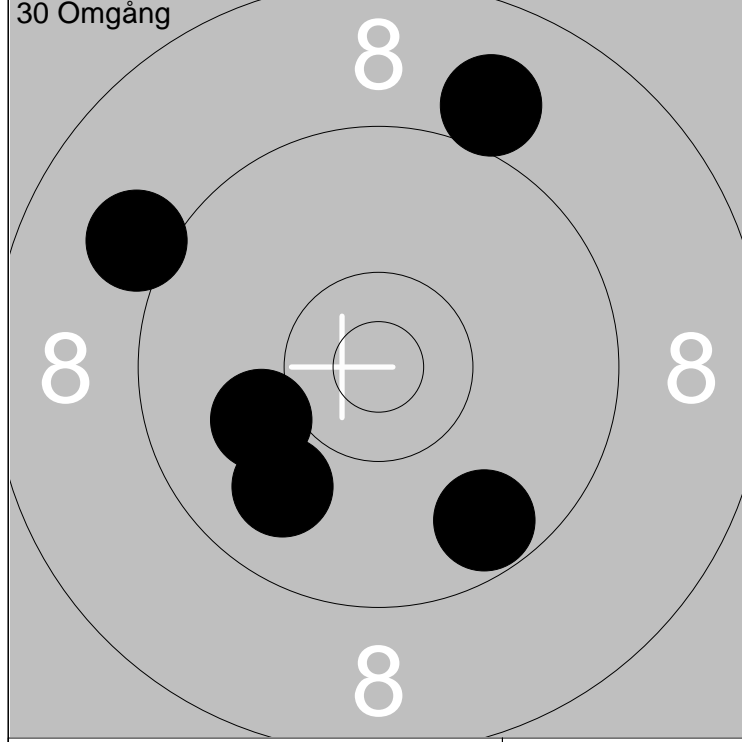

11: 9	↖		Serie	46
12: 9	↓			
13: 9	↑			
14: 10	←			
15: 9	↖			
			Total	138

16: 7	↑		Serie	43
17: 9	↗			
18: *10	↗			
19: 8	↗			
20: 9	←			
			Total	181

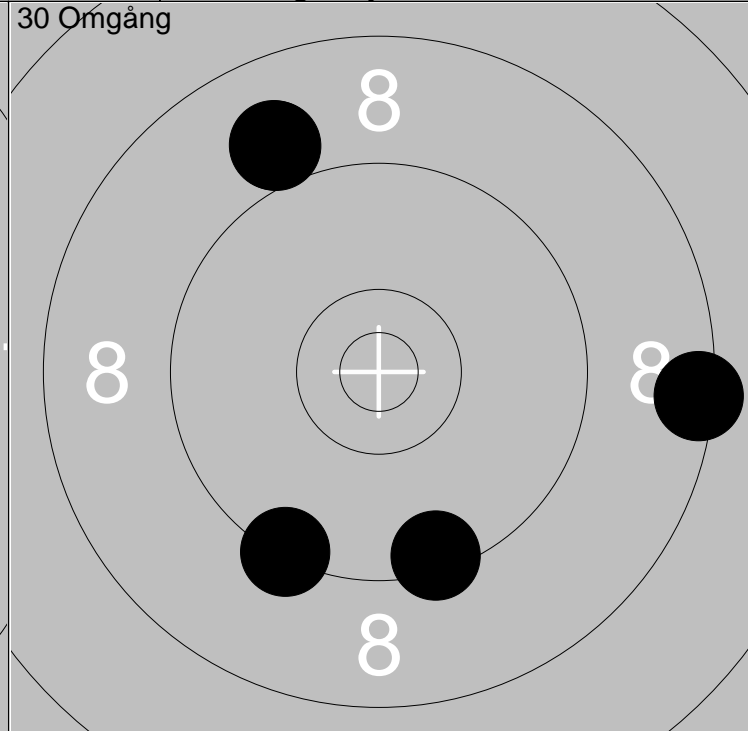
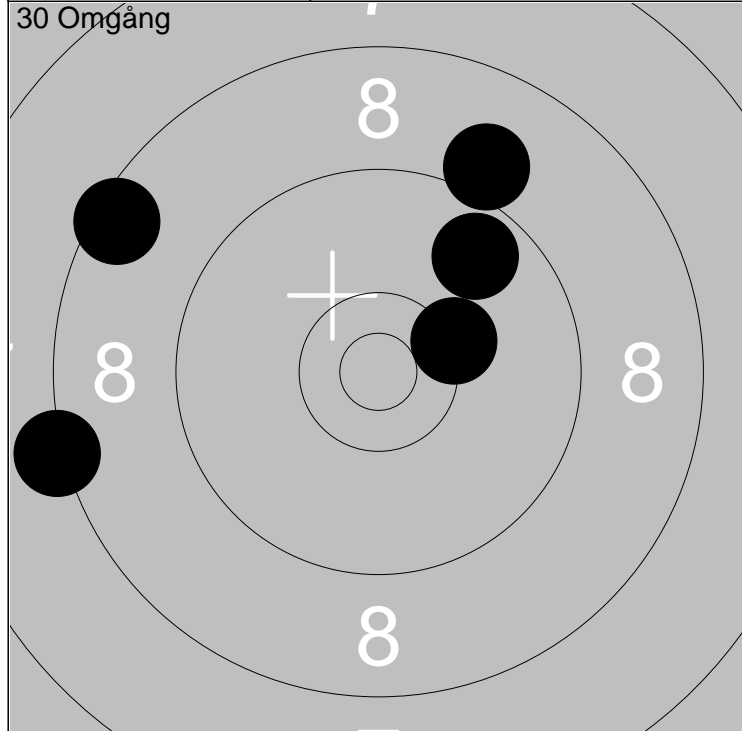

1: 9 ↗	Serie 44
2: 10 →	
3: 8 ←	Total 44
4: 8 ↖	
5: 9 ↗	

6: 9 ↗	Serie 44
7: 9 ↗	
8: 8 →	Total 88
9: 9 ↘	
10: 9 ↘	

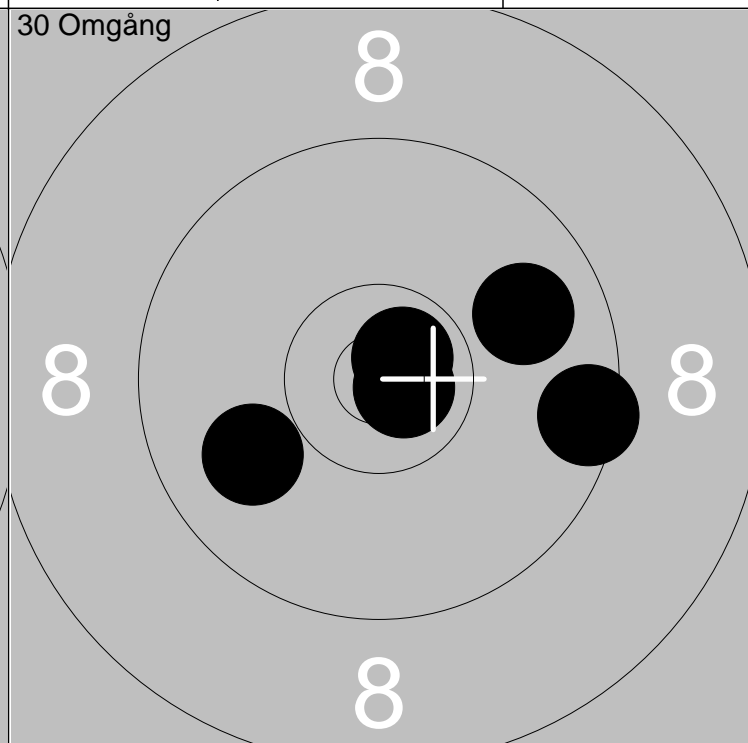
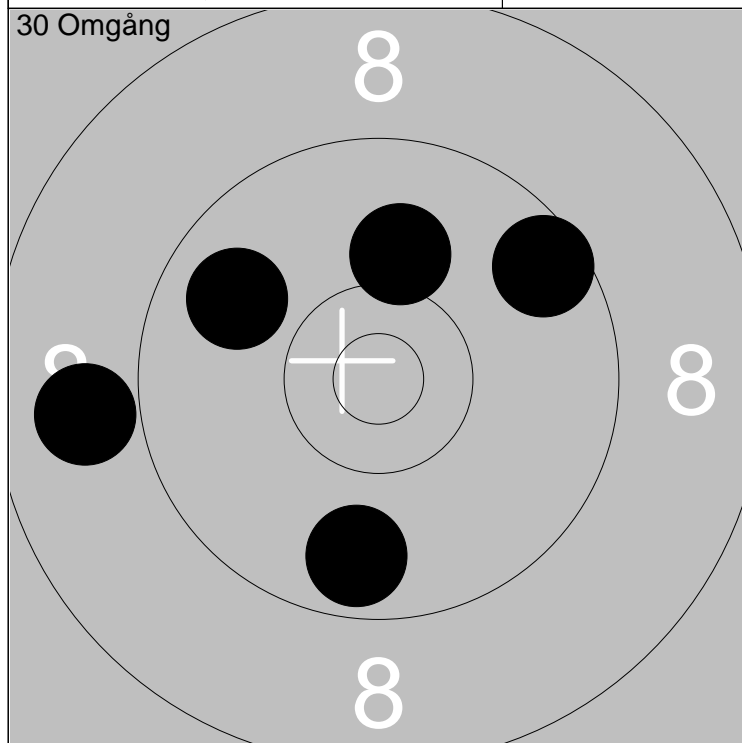

11: 9 ↖	Serie 45
12: 9 ↓	
13: 9 ↗	Total 133
14: 8 ←	
15: 10 ↑	

16: 9 →	Serie 47
17: 9 →	
18: *10 →	Total 180
19: *10 ↗	
20: 9 ↖	

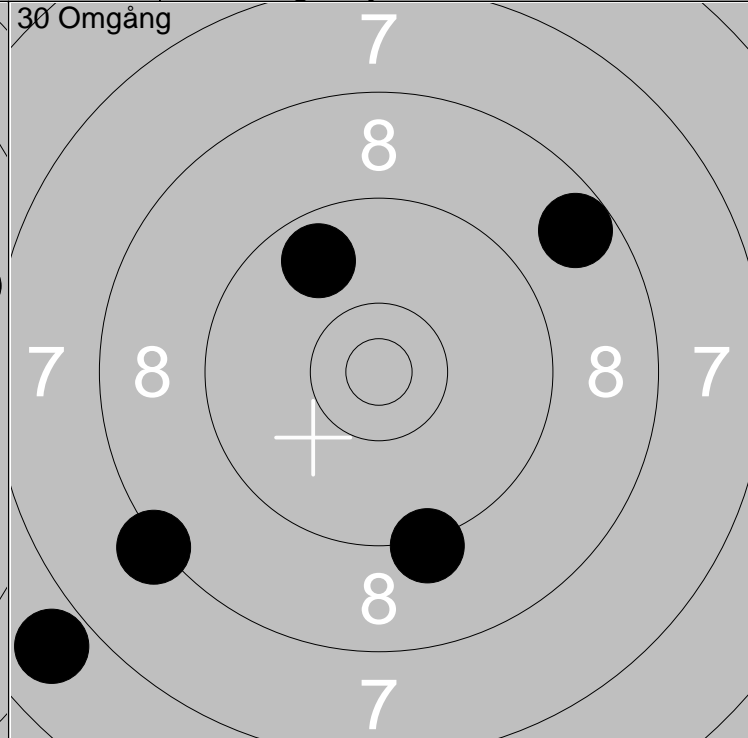
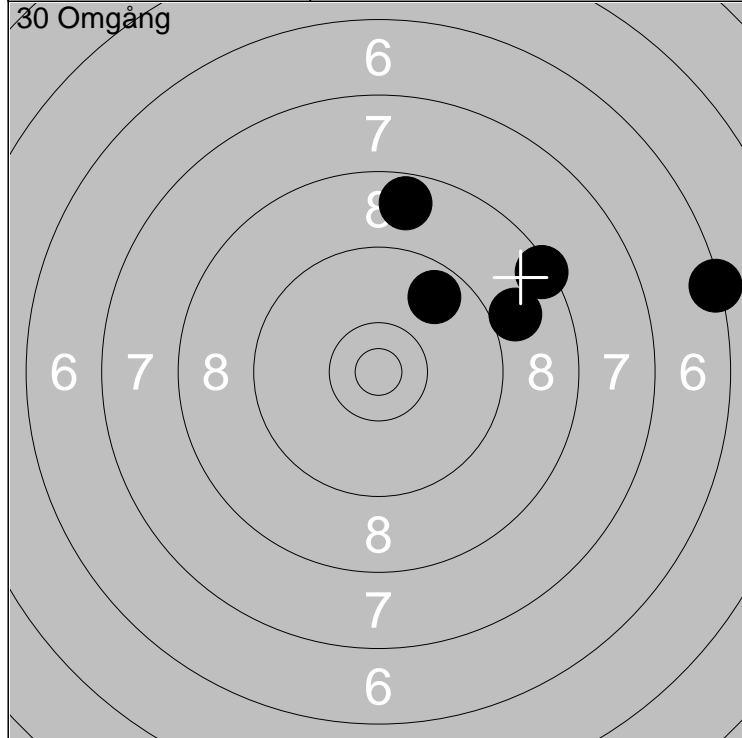

1: 9	→	Serie	40
2: 9	↗		
3: 8	↑		
4: 6	→		
5: 8	↗		
Total			40

6: 8	↙	Serie	40
7: 6	↙		
8: 9	↘		
9: 9	↗		
10: 8	↗		
Total			80

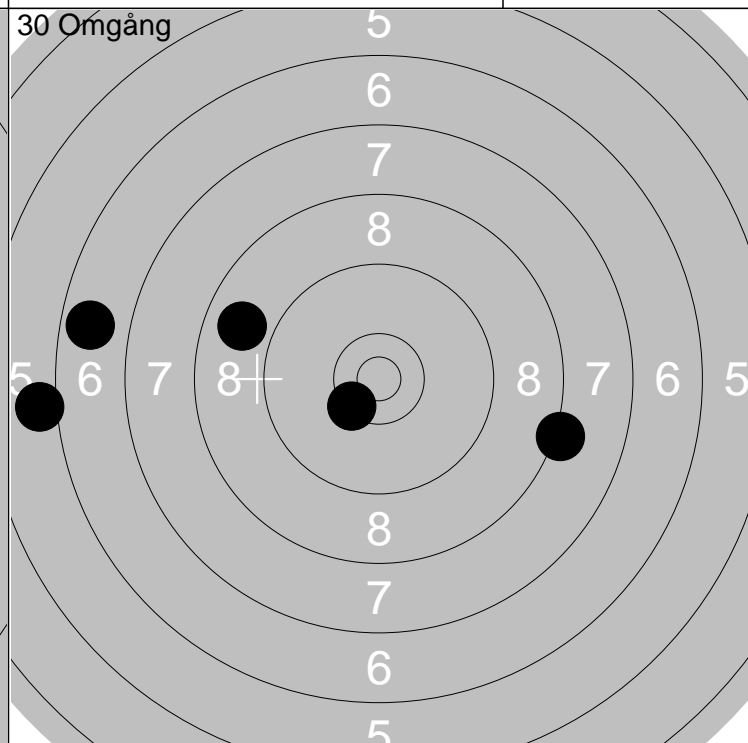
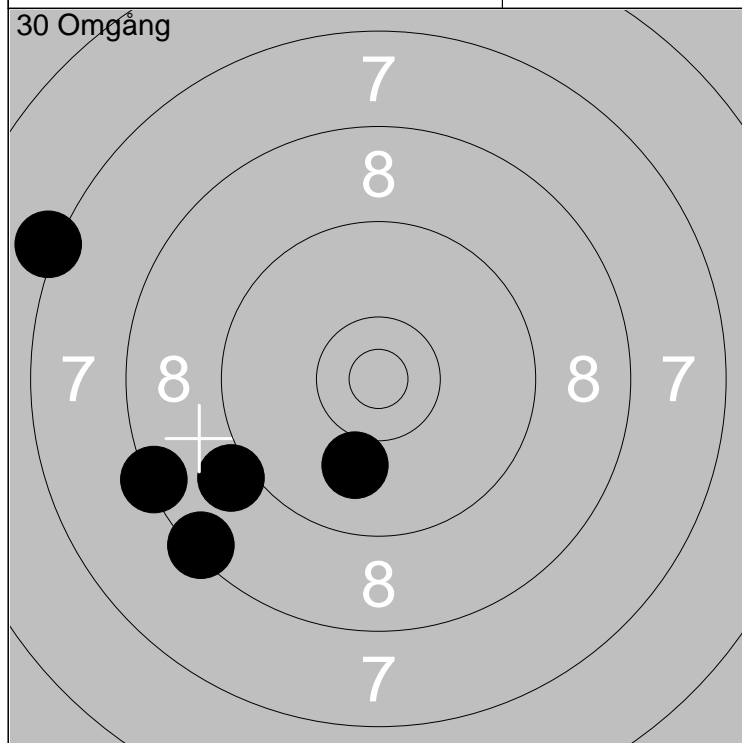

11: 10	↓	Serie	42
12: 9	↙		
13: 7	↙		
14: 8	↙		
15: 8	↙		
Total			122

16: 6	←	Serie	38
17: *10	↙		
18: 8	→		
19: 8	↙		
20: 6	←		
Total			160

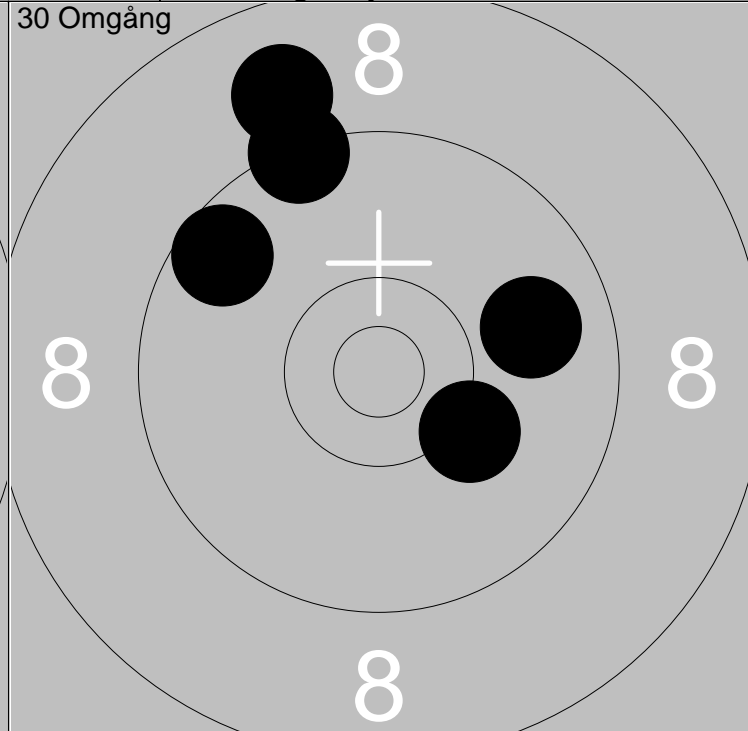
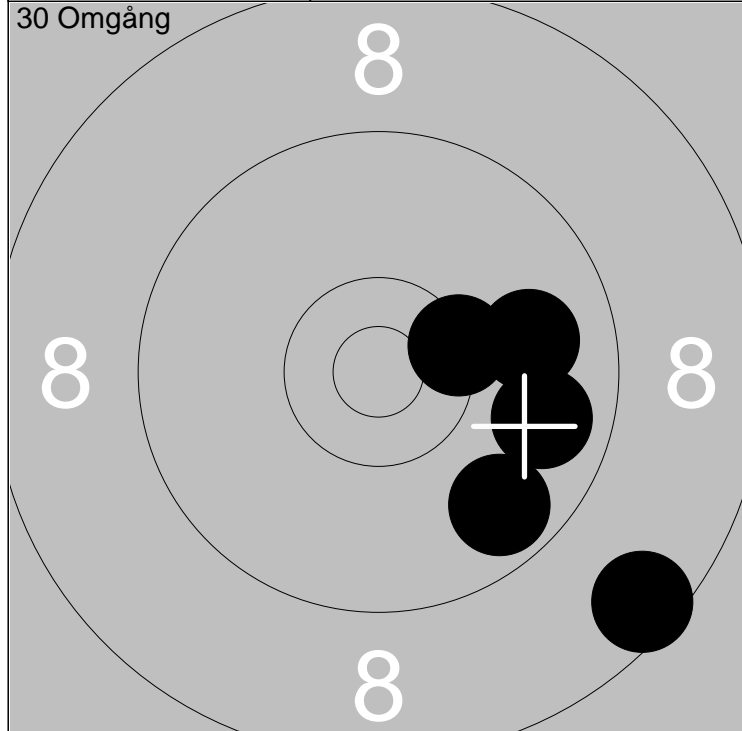

1: 9 ↘	Serie	45
2: *10 →		
3: 8 ↘	Total	45
4: 9 →		
5: 9 →		

6: 9 →	Serie	45
7: 8 ↗		
8: 9 ↗	Total	90
9: 10 ↘		
10: 9 ↗		

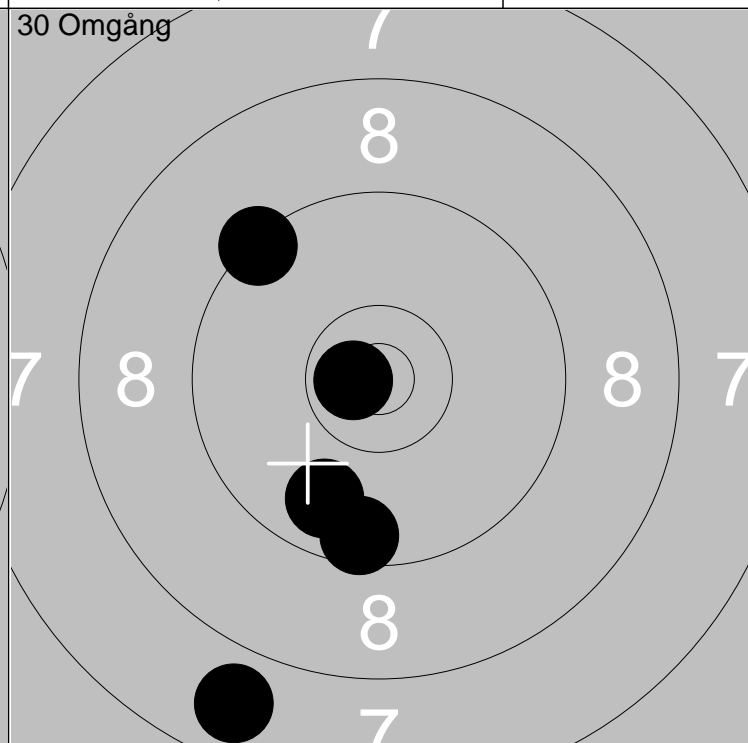
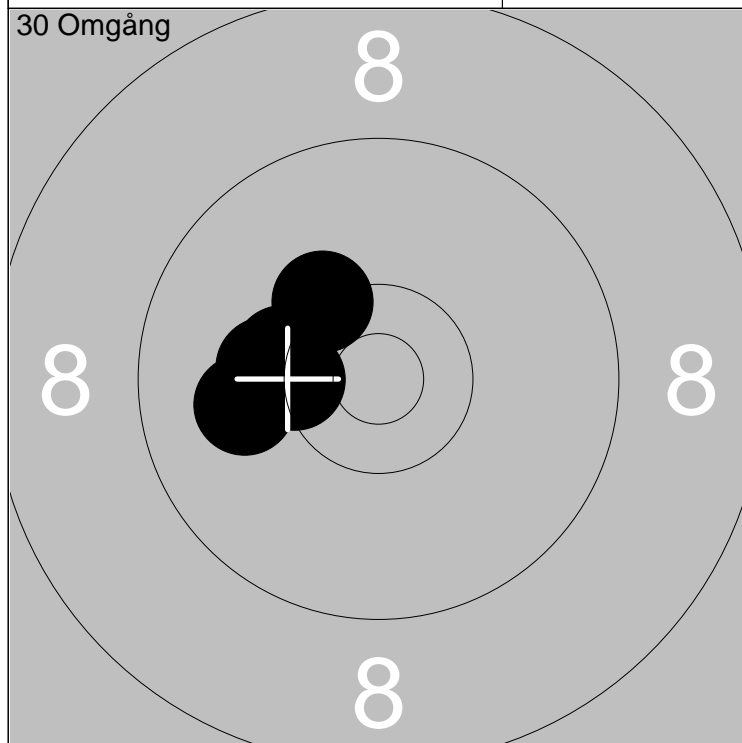

11: *10 ←	Serie	50
12: *10 ↗		
13: 10 ←	Total	140
14: 10 ←		
15: 10 ←		

16: 7 ↘	Serie	44
17: 9 ↘		
18: 9 ↘	Total	184
19: 9 ↗		
20: *10 ←		

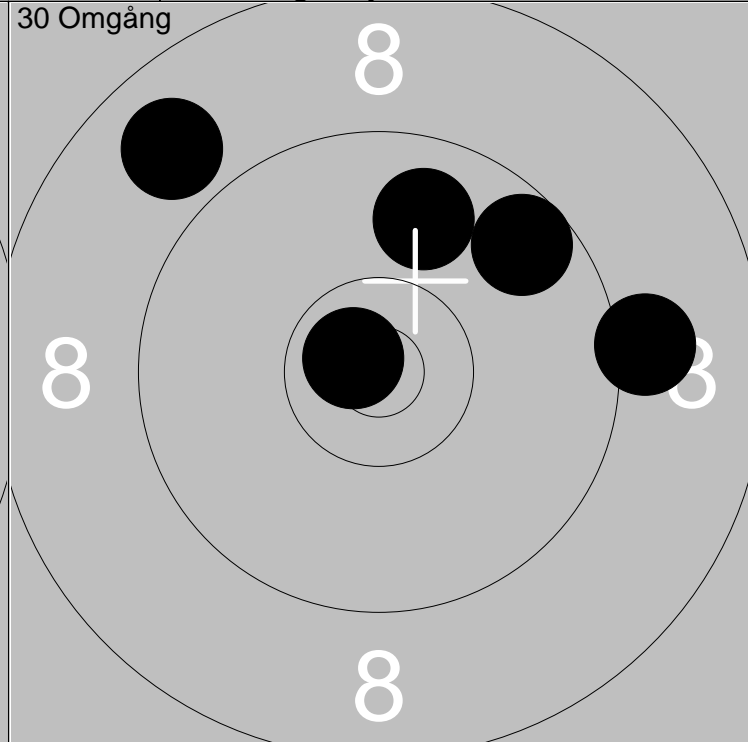
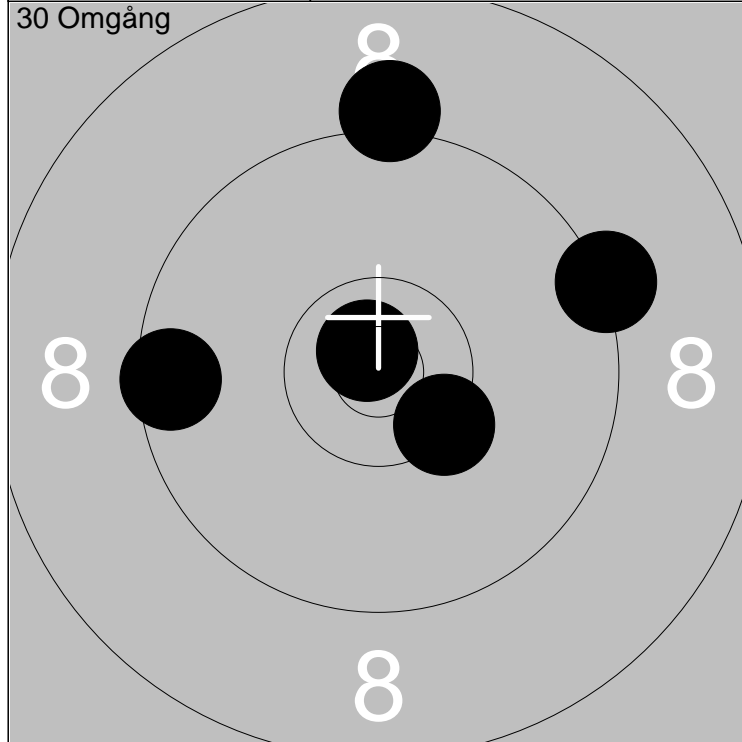

1:	9	←
2:	*10	↘
3:	*10	↗
4:	9	→
5:	9	↑

Serie	47
Total	47

6:	9	→
7:	*10	←
8:	8	↖
9:	9	↗
10:	9	↑

Serie	45
Total	92

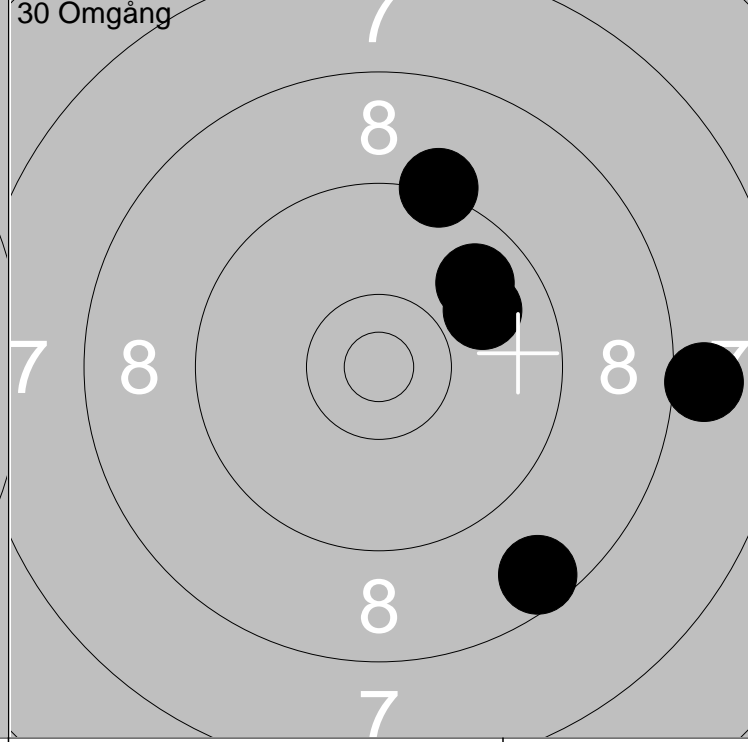
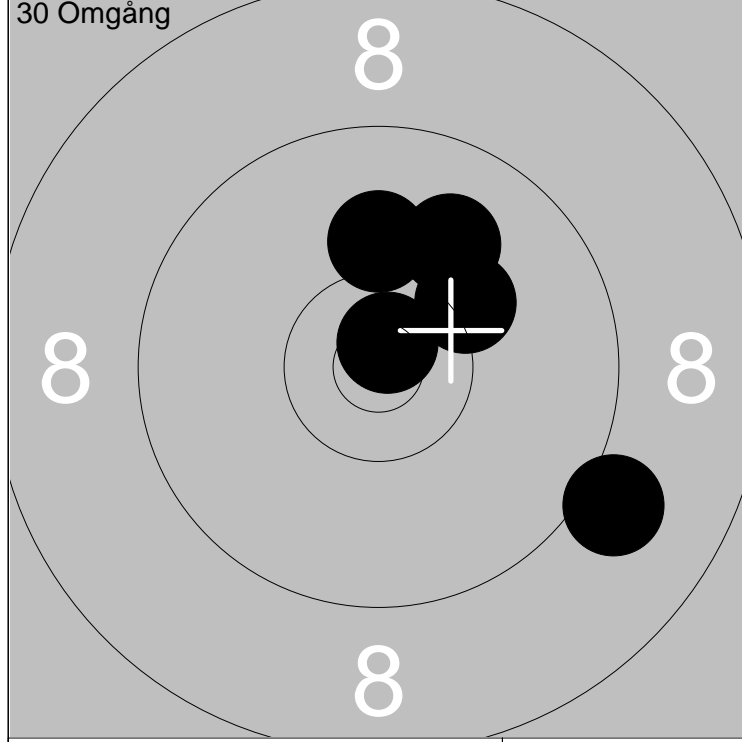

11:	10	↗
12:	9	↘
13:	10	↑
14:	10	↗
15:	*10	↑

Serie	49
Total	141

16:	8	→
17:	9	↗
18:	9	↑
19:	8	↘
20:	9	↗

Serie	43
Total	184

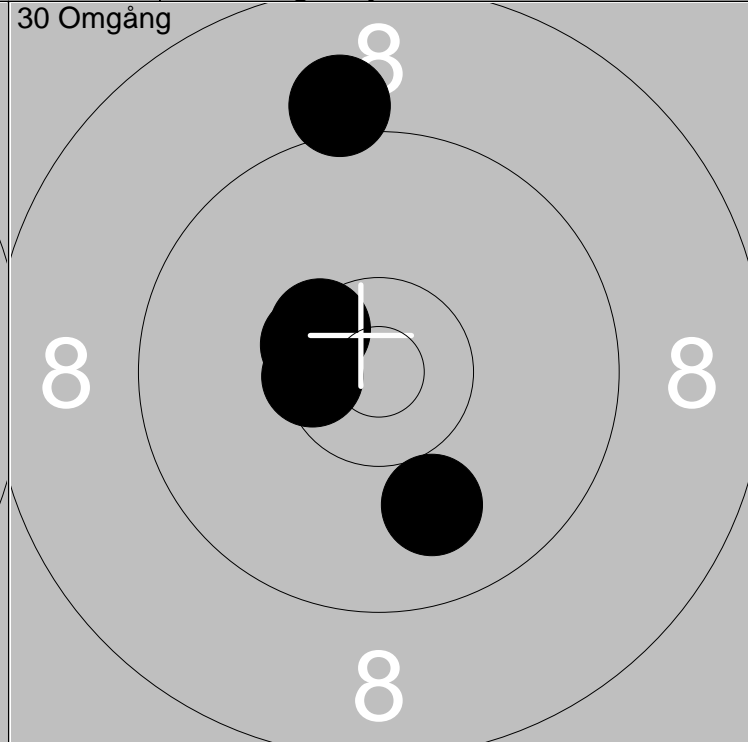
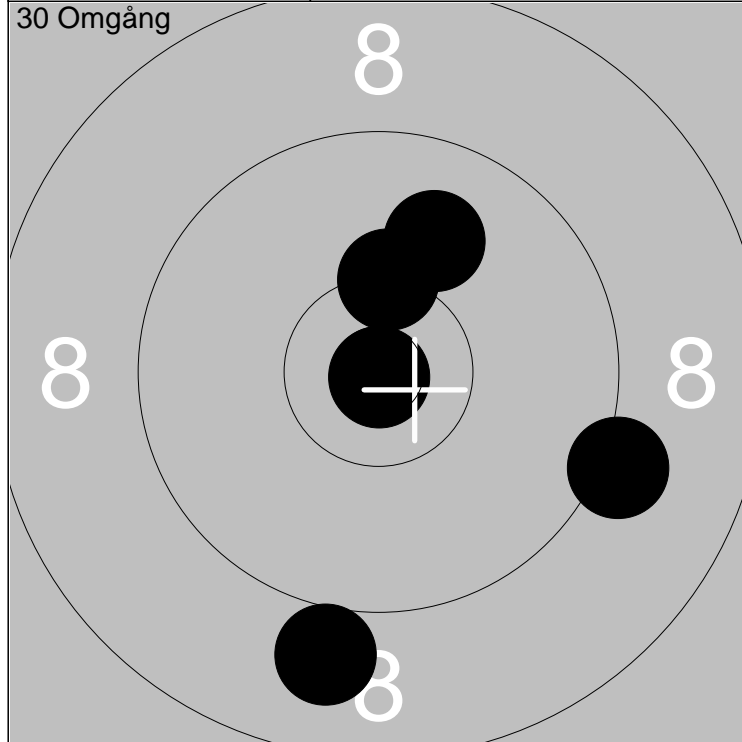

1: *10 ↑	Serie	48	6: 9 ↑	Serie	49
2: 9 ↓			7: 10 ↓		
3: 9 →	Total	48	8: *10 ←	Total	97
4: 10 ↗			9: *10 ↖		
5: *10 ↓			10: *10 ↖		

6: 9 ↑	Serie	49	17: 9 ↑	Serie	49
7: 10 ↓			18: *10 ←		
8: *10 ←	Total	97	19: *10 ↓	Total	193
9: *10 ↖			20: 10 ↗		
10: *10 ↖					

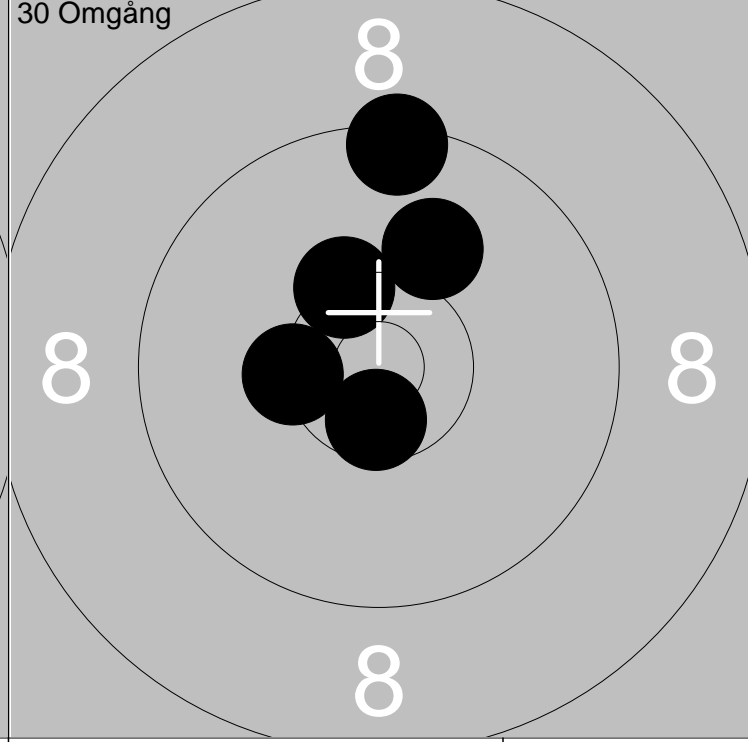
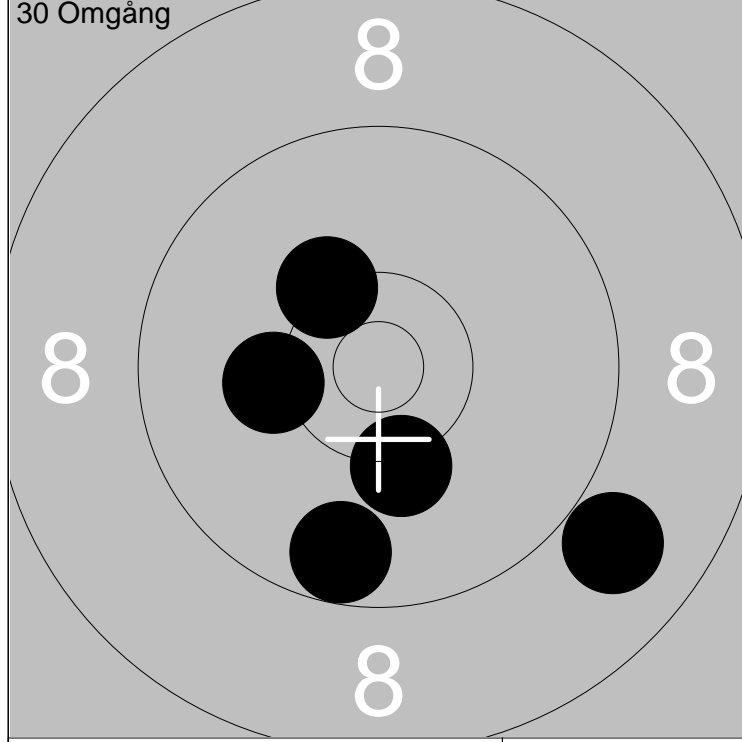

11: *10 ↗	Serie	47	16: *10 ↗	Serie	49
12: 10 ↓			17: 9 ↑		
13: 8 ↓	Total	144	18: *10 ←	Total	193
14: 9 ↓			19: *10 ↓		
15: 10 ←			20: 10 ↗		

16: *10 ↗	Serie	49	17: 9 ↑	Serie	49
17: 9 ↑			18: *10 ←		
18: *10 ←	Total	193	19: *10 ↓	Total	193
19: *10 ↓			20: 10 ↗		
20: 10 ↗					

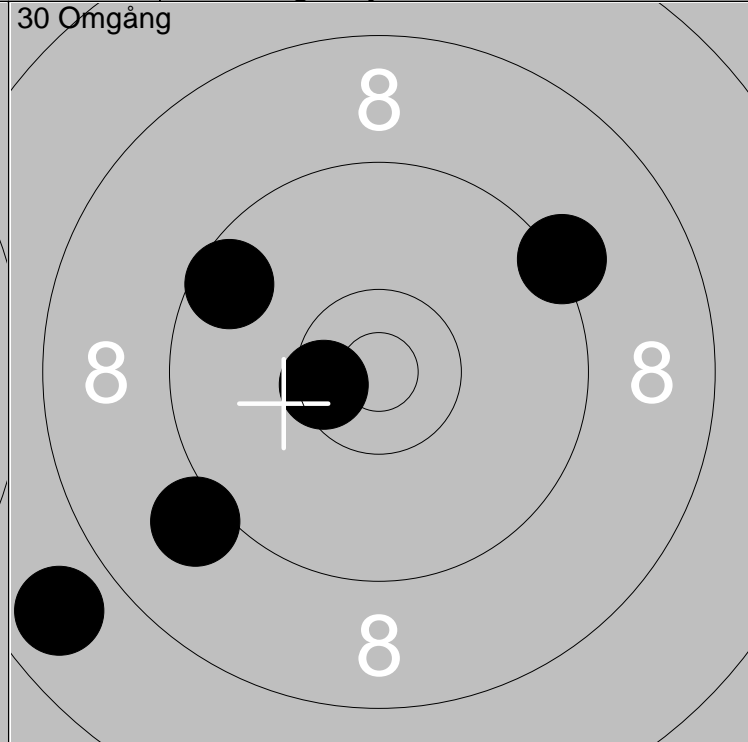
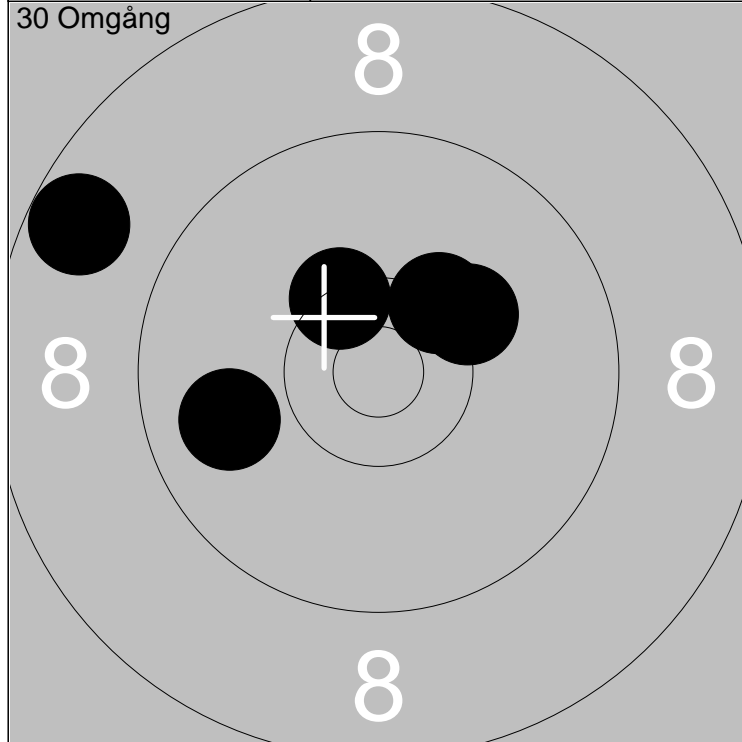

1: 9 ←	Serie	47
2: 8 ↙		
3: *10 ↗	Total	47
4: 10 ↗		
5: *10 ↖		

6: 9 ↖	Serie	44
7: 9 ↗		
8: 7 ↙	Total	91
9: *10 ←		
10: 9 ↙		

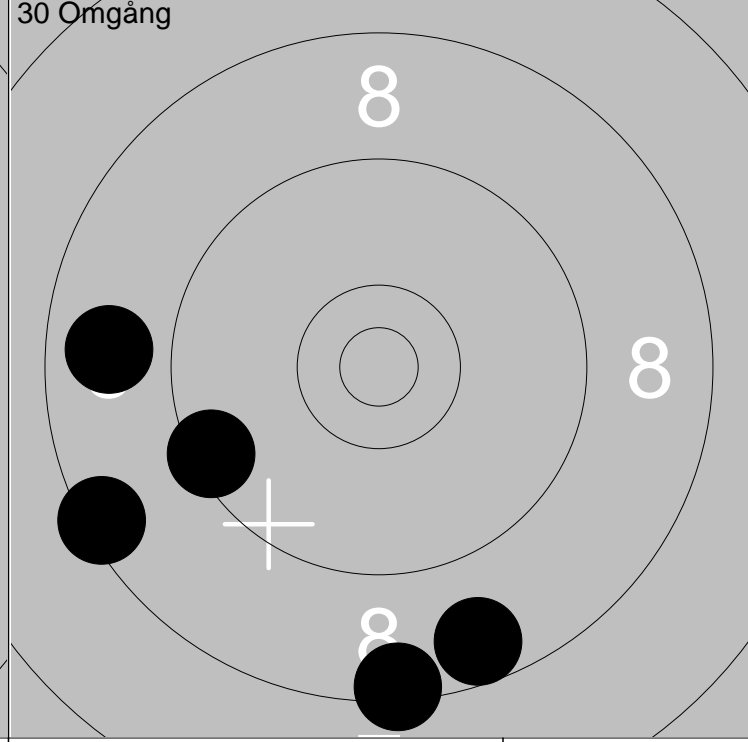
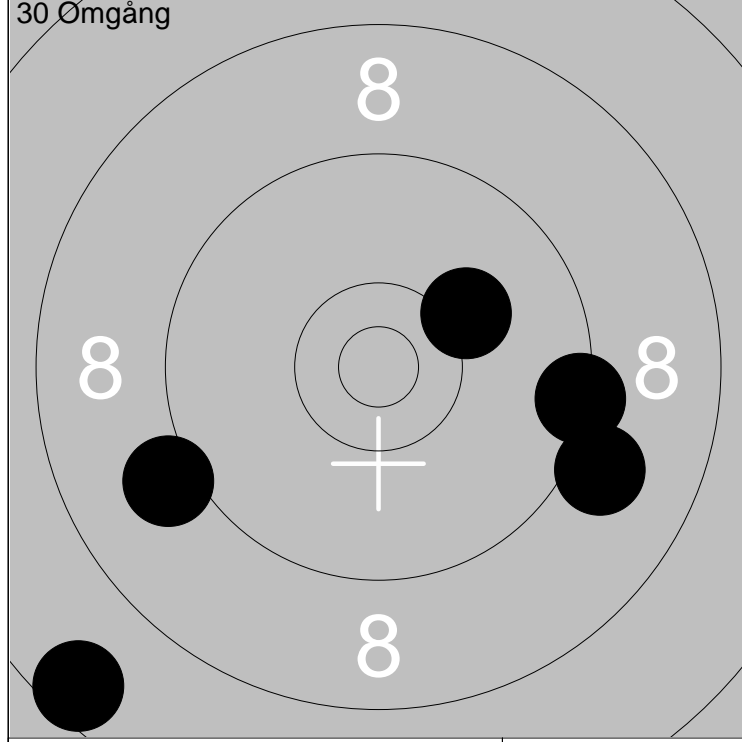

11: 9 →	Serie	44
12: 9 →		
13: 9 ↙	Total	135
14: 7 ↙		
15: 10 ↗		

16: 9 ↙	Serie	41
17: 8 ↙		
18: 8 ↘	Total	176
19: 8 ↘		
20: 8 ←		

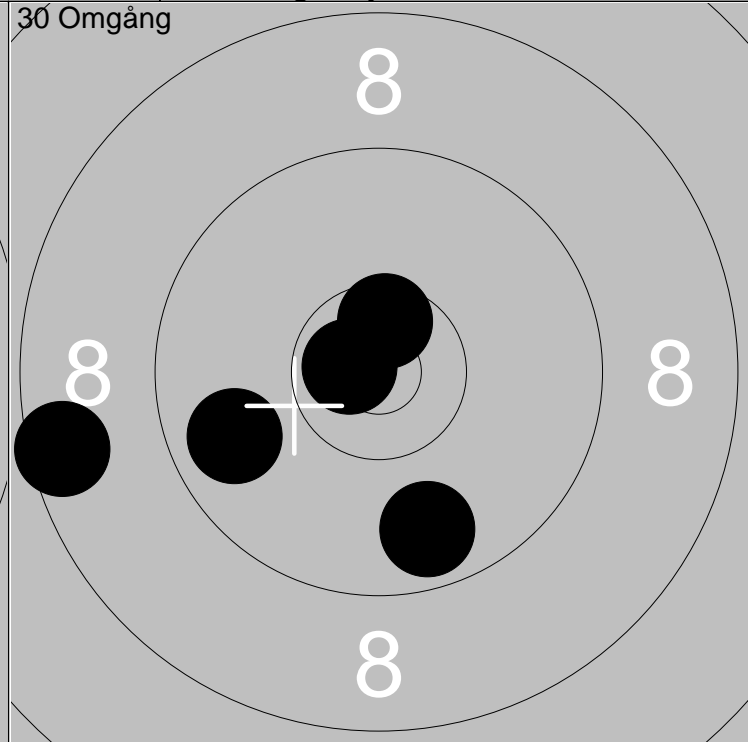
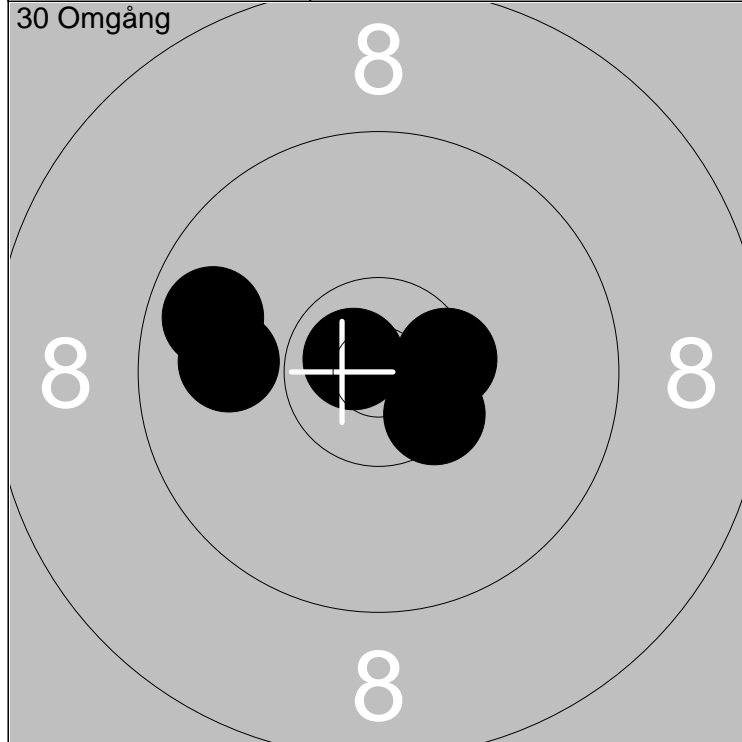

1: *10 ↘
2: *10 →
3: *10 ↗
4: 9 ←
5: 9 ←

Serie	48
Total	48

6: *10 ↑
7: *10 ←
8: 9 ↓
9: 9 ←
10: 8 ←

Serie	46
Total	94

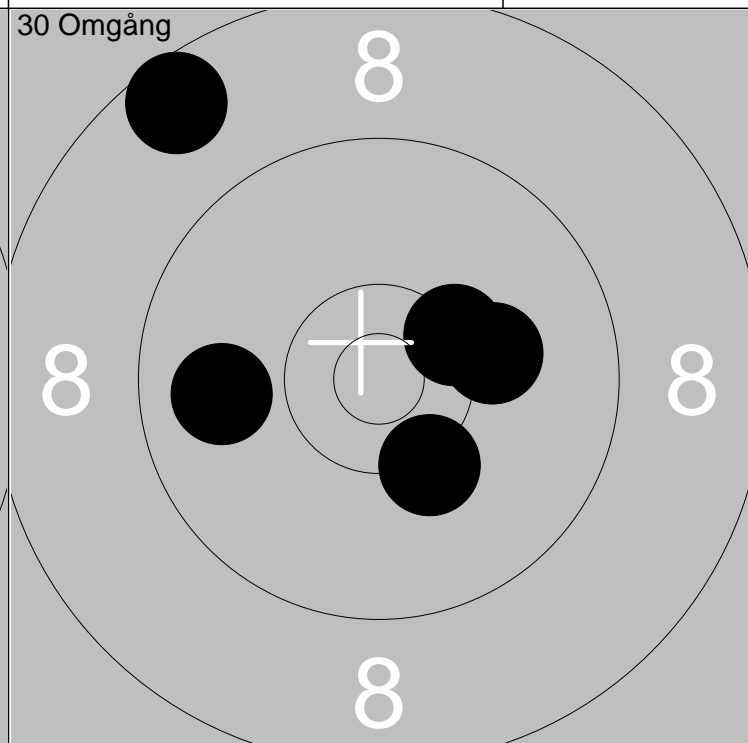
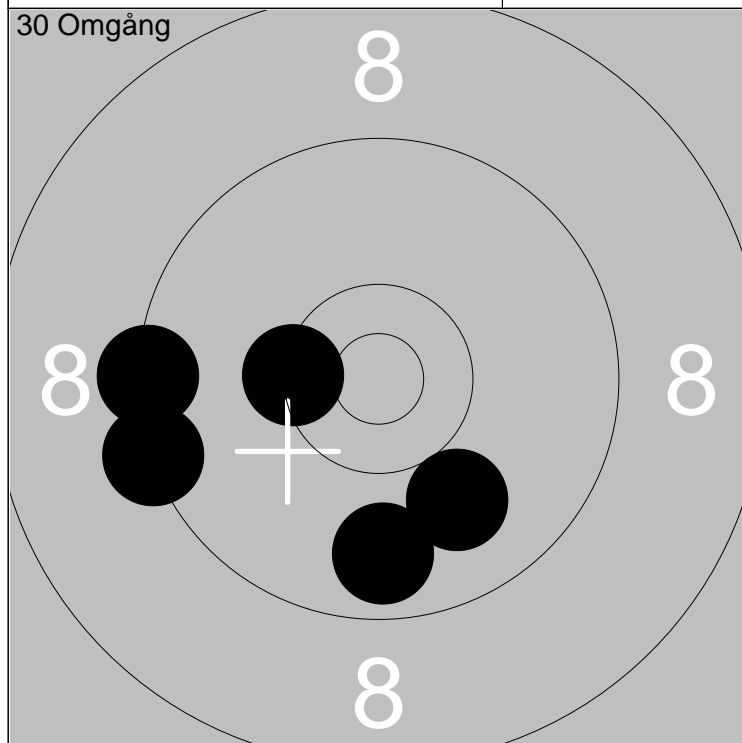

11: 9 ←
12: *10 ←
13: 9 ↓
14: 9 ←
15: 10 ↓

Serie	47
Total	141

16: 10 ↓
17: *10 ↗
18: 8 ↗
19: 9 ←
20: 10 →

Serie	47
Total	188

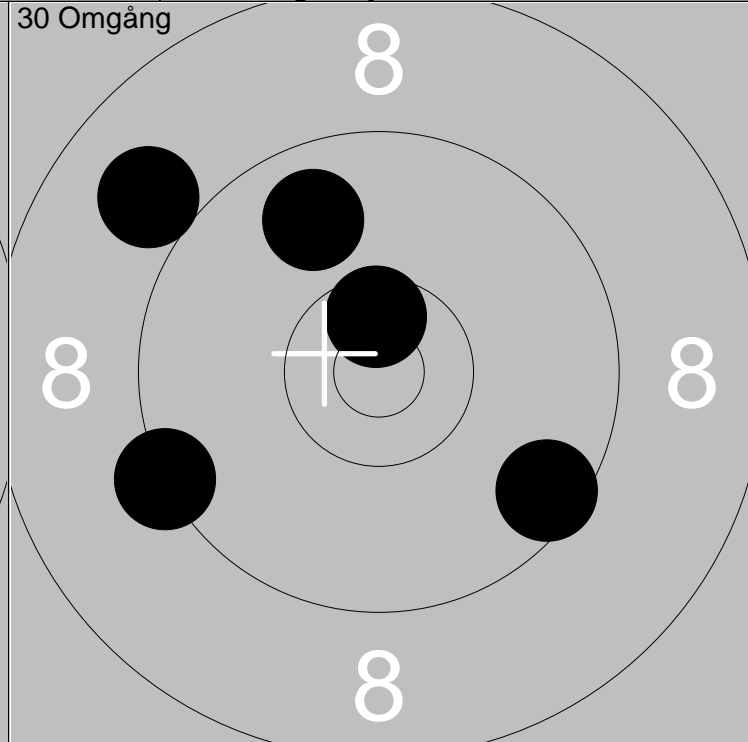
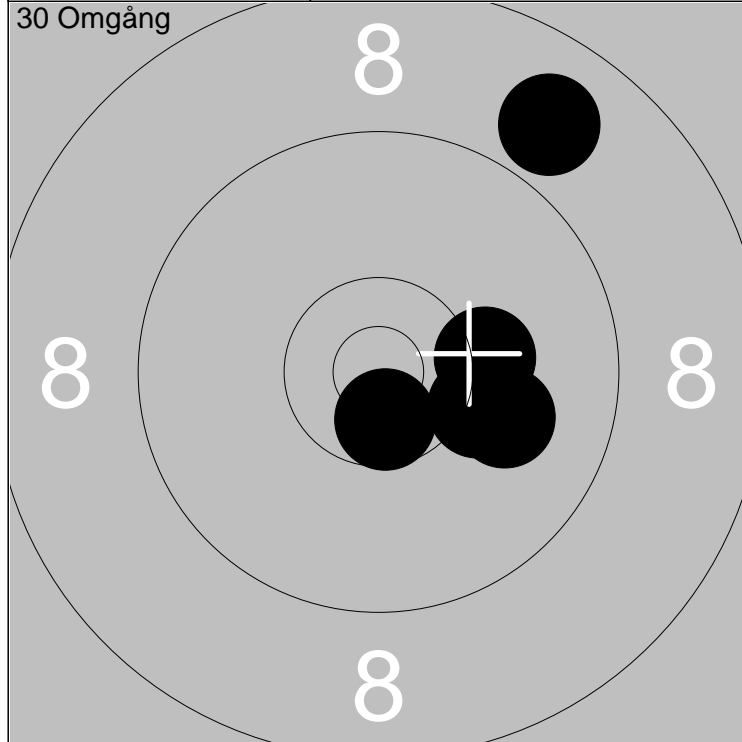

1: *10	↓
2: 10	↘
3: 10	→
4: 10	↘
5: 8	↗

Serie	48
Total	48

6: 9	↘
7: 9	↗
8: 9	↙
9: 9	↖
10: *10	↑

Serie	46
Total	94

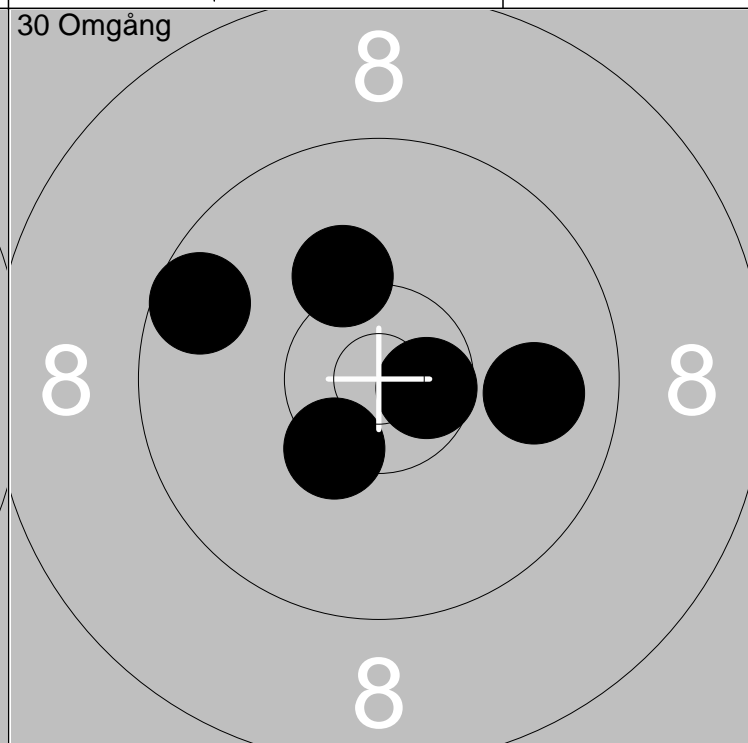
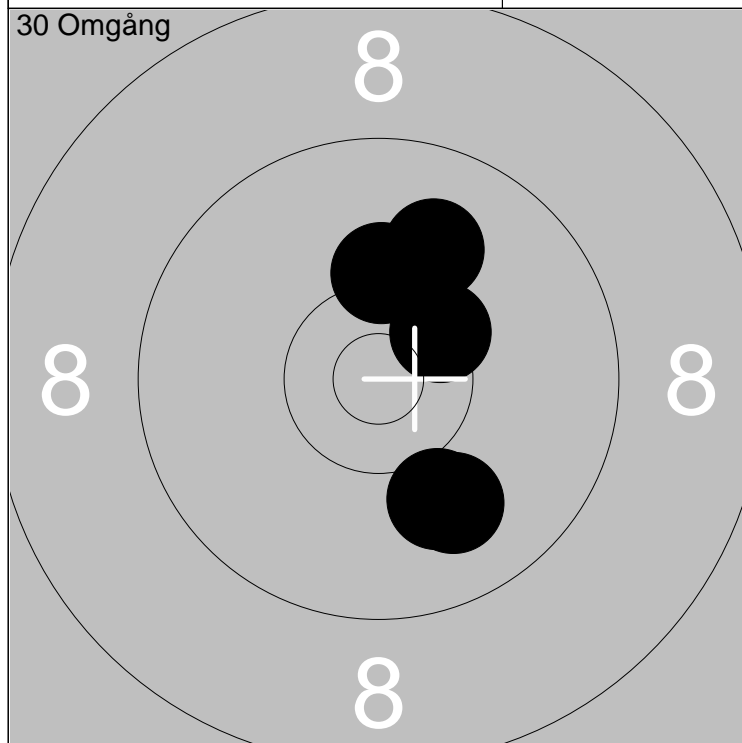

11: 10	↗
12: *10	↘
13: 10	↑
14: 10	↘
15: 10	↘

Serie	50
Total	144

16: *10	→
17: 9	→
18: 10	↗
19: *10	↘
20: 9	↖

Serie	48
Total	192

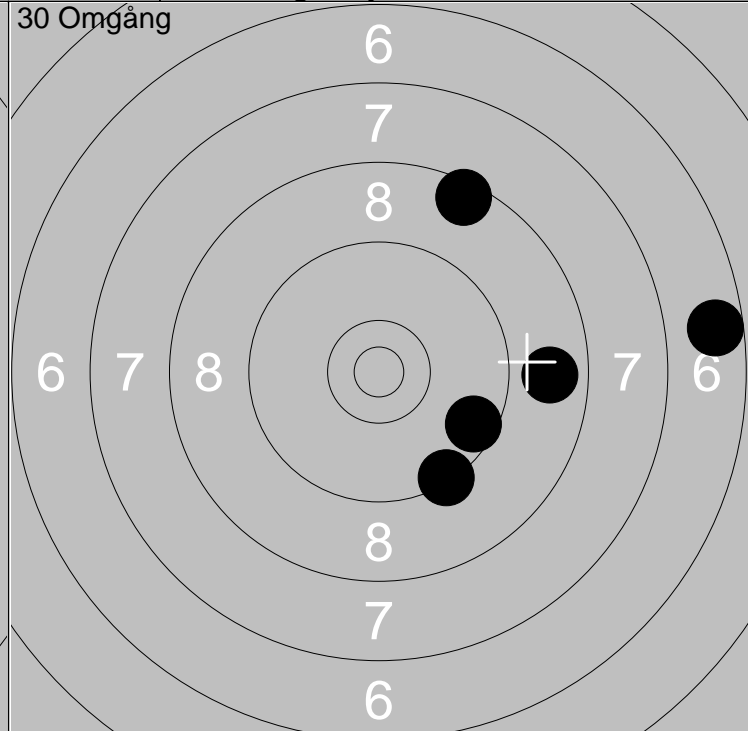

1: 9	↑	Serie	40
2: 6	↗		
3: 9	→		
4: 8	↖		
5: 8	↓		
Total			40

6: 9	↘	Serie	40
7: 6	→		
8: 9	↘		
9: 8	→		
10: 8	↑		
Total			80

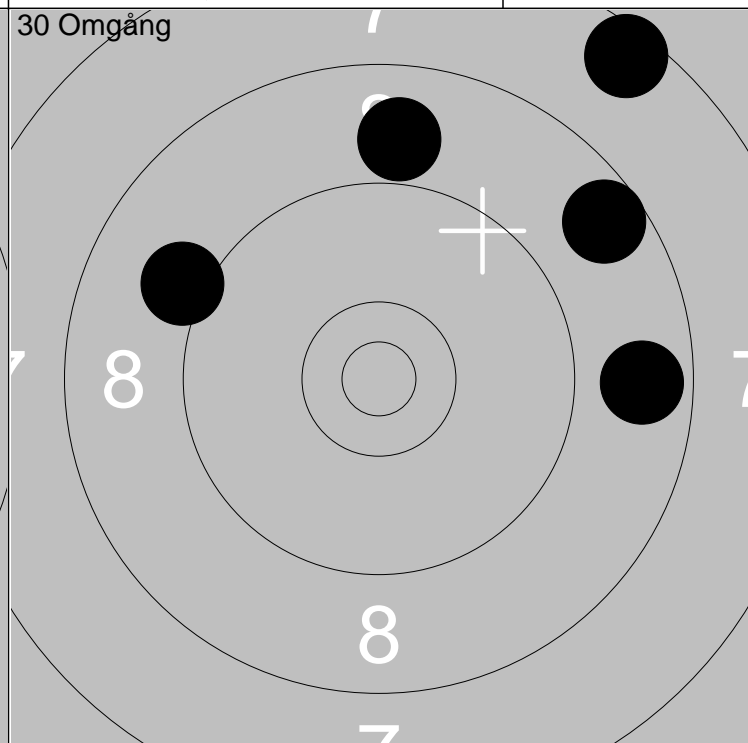
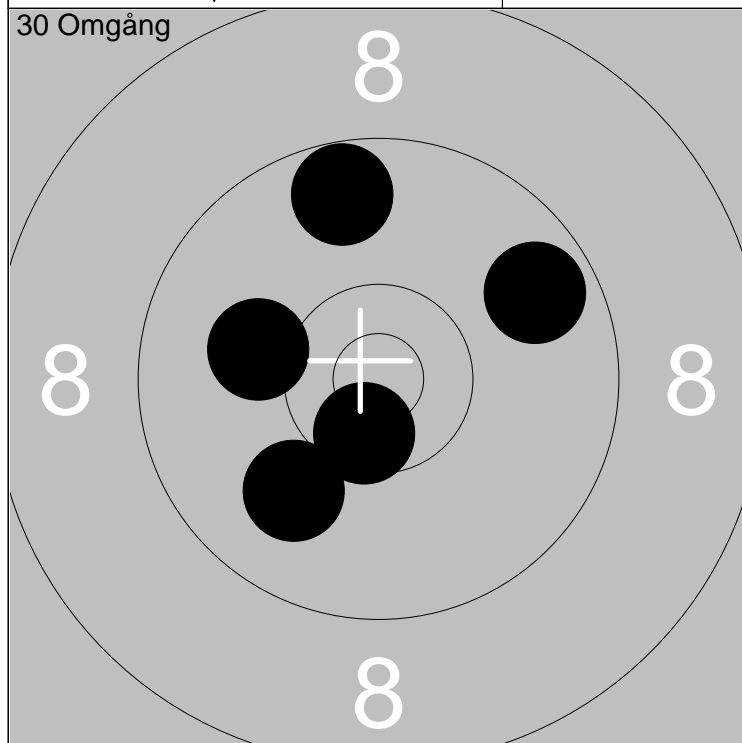

11: *10	↓	Serie	48
12: 10	↘		
13: 9	↑		
14: 10	↖		
15: 9	↗		
Total			128

16: 7	↗	Serie	40
17: 8	→		
18: 8	↗		
19: 9	↖		
20: 8	↑		
Total			168

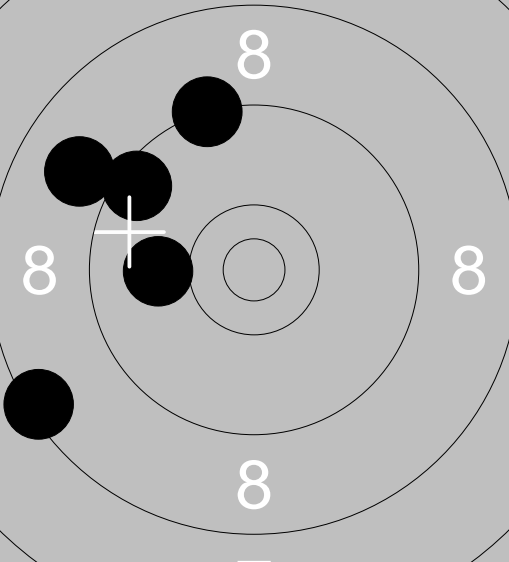
<p>30 Omgång</p>  <p style="text-align: center;">7</p>	<p>1: 10 ←</p> <p>2: 9 ↑</p> <p>3: 9 ↗</p> <p>4: 8 ↗</p> <p>5: 8 ↙</p>	<p>30 Omgång</p>  <p style="text-align: center;">7</p>	<p>6: 9 →</p> <p>7: 9 ↑</p> <p>8: 9 ↖</p> <p>9: 9 ↑</p> <p>10: *10 ←</p>
Serie 44	Total 44	Serie 46	Total 90

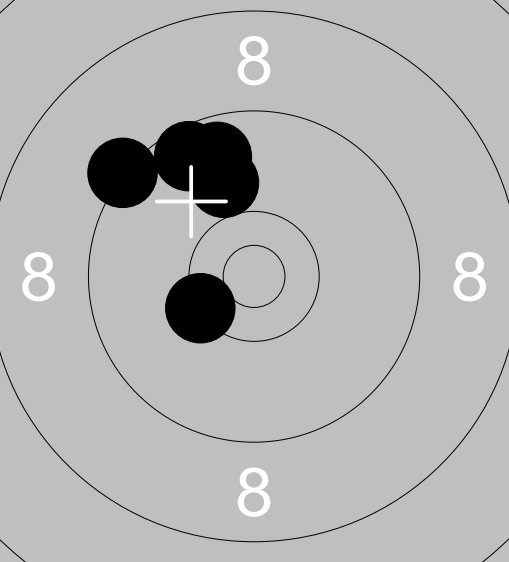
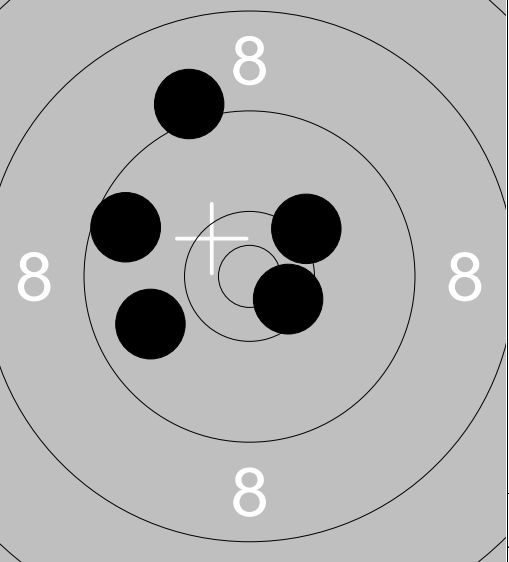
<p>30 Omgång</p>  <p style="text-align: center;">7</p>	<p>11: 9 ↑</p> <p>12: *10 ←</p> <p>13: 10 ↑</p> <p>14: 9 ↗</p> <p>15: 9 ↗</p>	<p>30 Omgång</p>  <p style="text-align: center;">7</p>	<p>16: *10 →</p> <p>17: 9 ↑</p> <p>18: 9 ↖</p> <p>19: 10 ↗</p> <p>20: 9 ←</p>
Serie 47	Total 137	Serie 47	Total 184

<p>30 Omgång</p>  <p style="text-align: center;">6</p>	<p>21: 7 ↓</p> <p>22: 7 ↙</p> <p>23: 6 ↓</p> <p>24: 6 ↓</p> <p>25: 8 ↓</p>	<p>30 Omgång</p>  <p style="text-align: center;">7</p>	<p>26: 9 ↙</p> <p>27: 10 ↓</p> <p>28: 10 ↑</p> <p>29: 9 ↑</p> <p>30: 8 ↑</p>
Serie 34	Total 218	Serie 46	Total 264

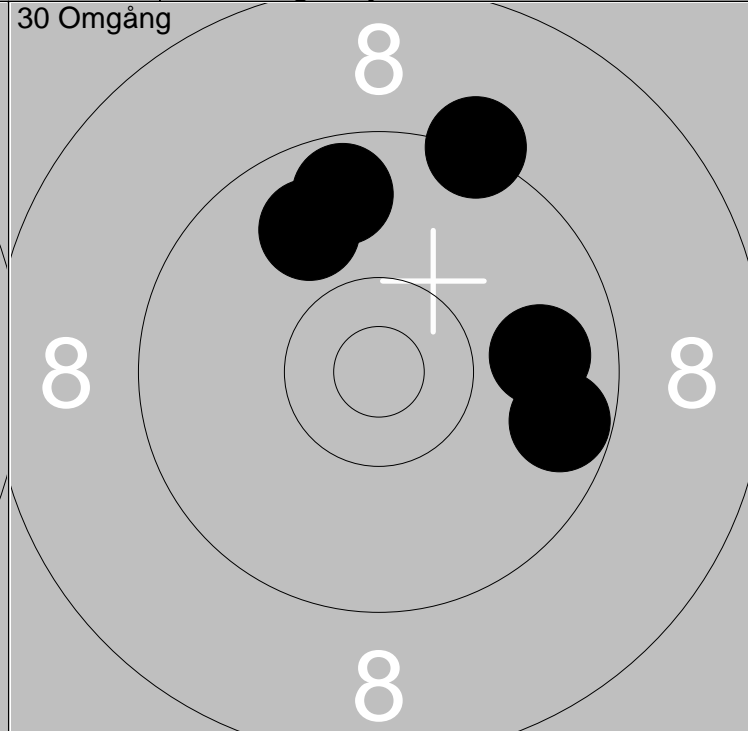
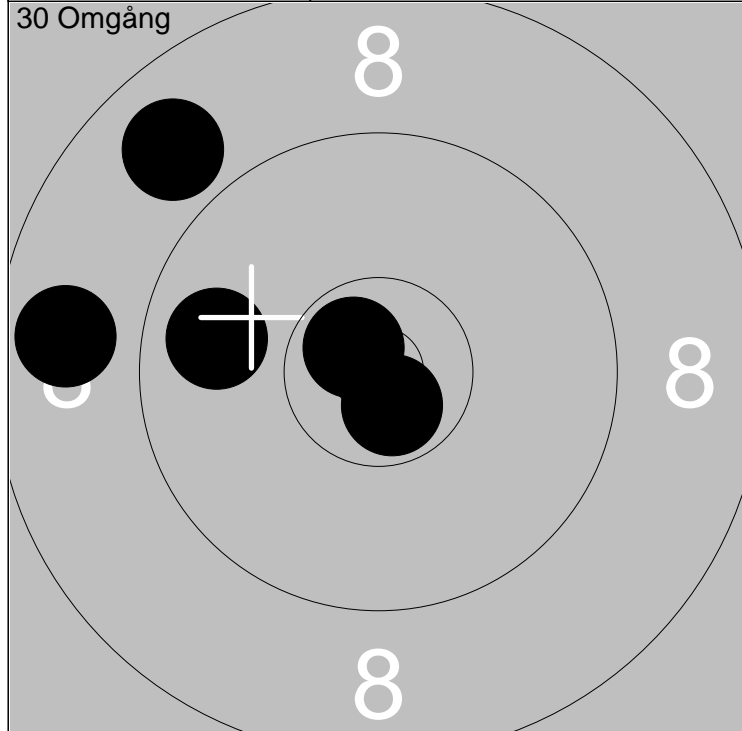

1: 9	←
2: *10	↘
3: *10	↗
4: 8	←
5: 8	↗

Serie	45
Total	45

6: 9	→
7: 9	↗
8: 9	↗
9: 9	→
10: 9	↗

Serie	45
Total	90

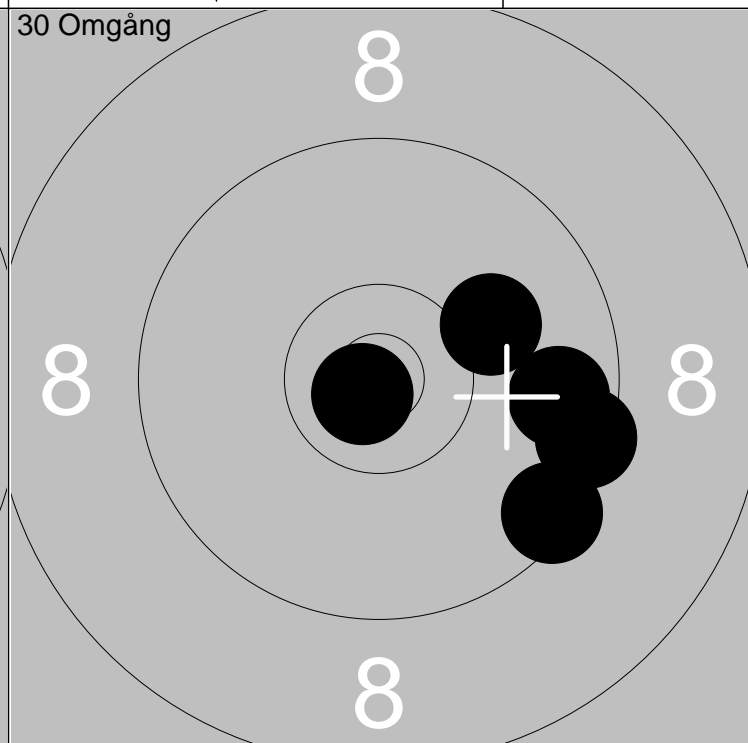
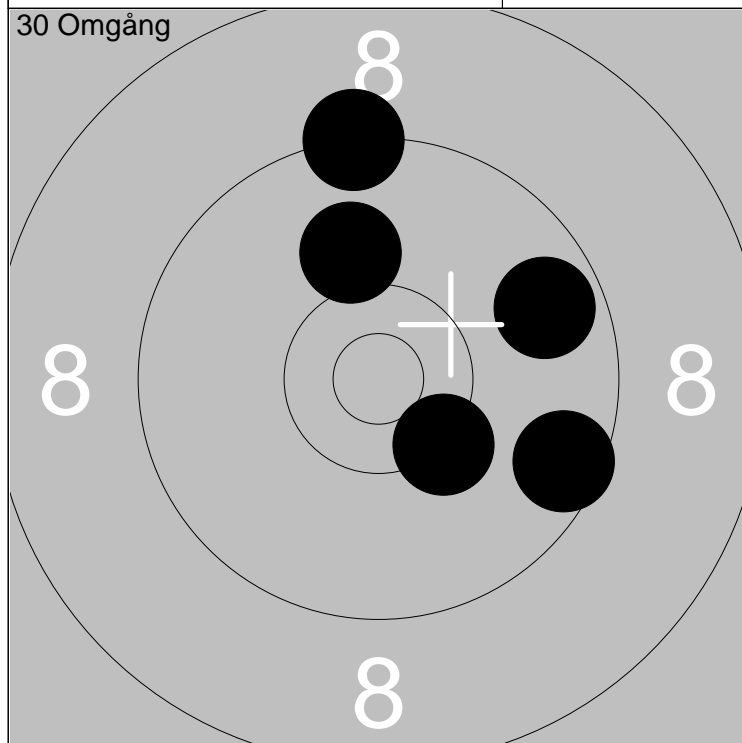

11: 9	↗
12: *10	↘
13: 10	↗
14: 9	↗
15: 9	↘

Serie	47
Total	137

16: 10	↗
17: *10	↘
18: 9	→
19: 9	→
20: 9	↘

Serie	47
Total	184

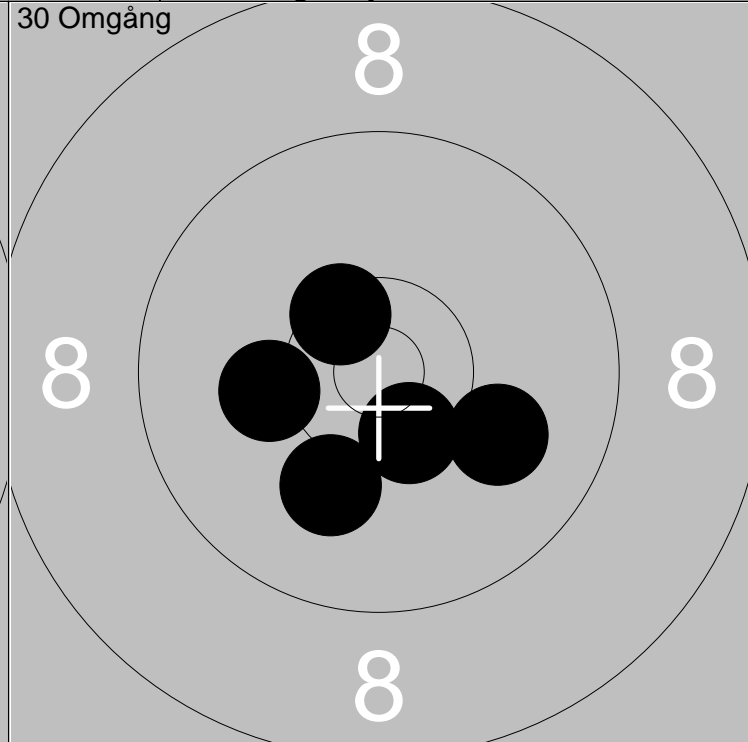
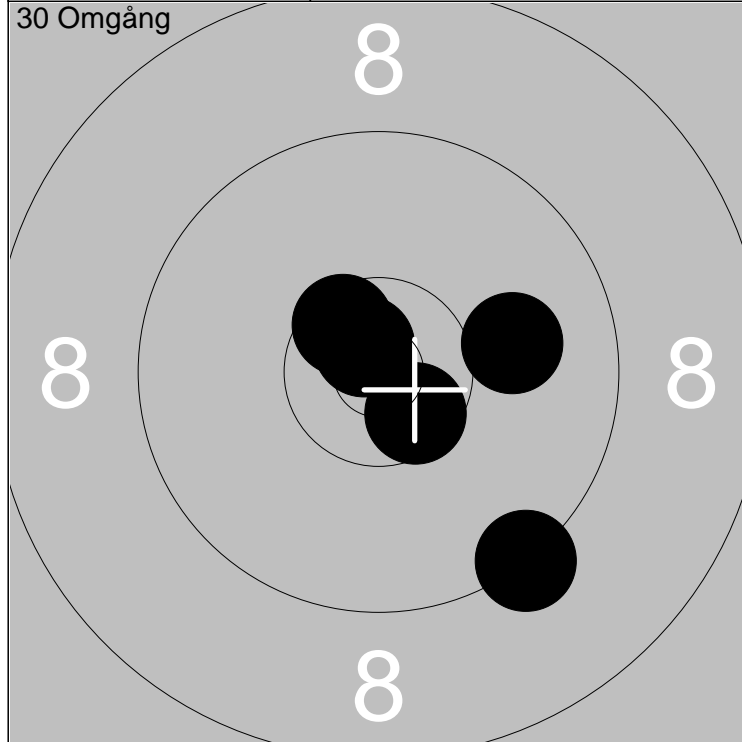

1: 9	↙
2: *10	↗
3: *10	↗
4: 10	→
5: *10	↘

Serie	49
Total	49

6: *10	↘
7: 10	↙
8: *10	↗
9: 10	↘
10: 10	←

Serie	50
Total	99

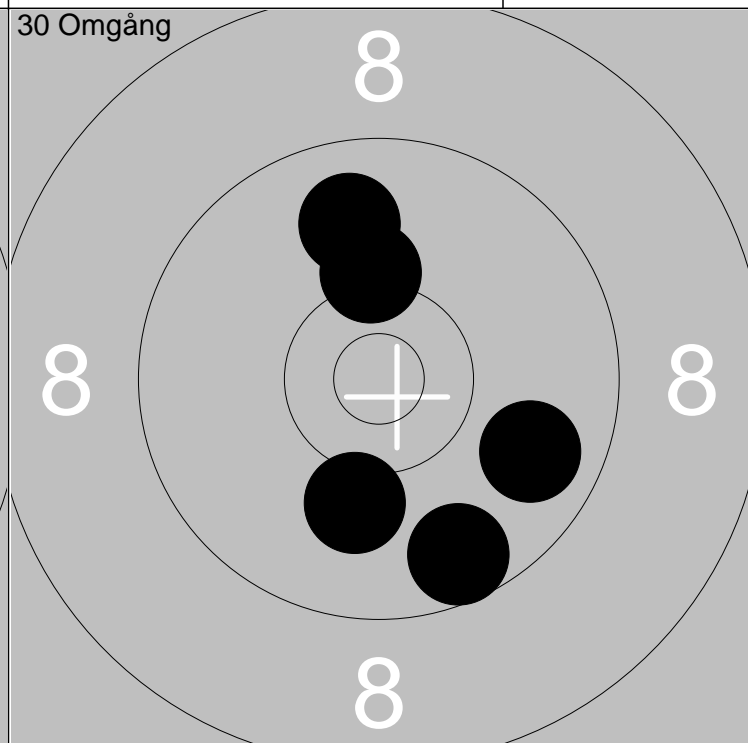
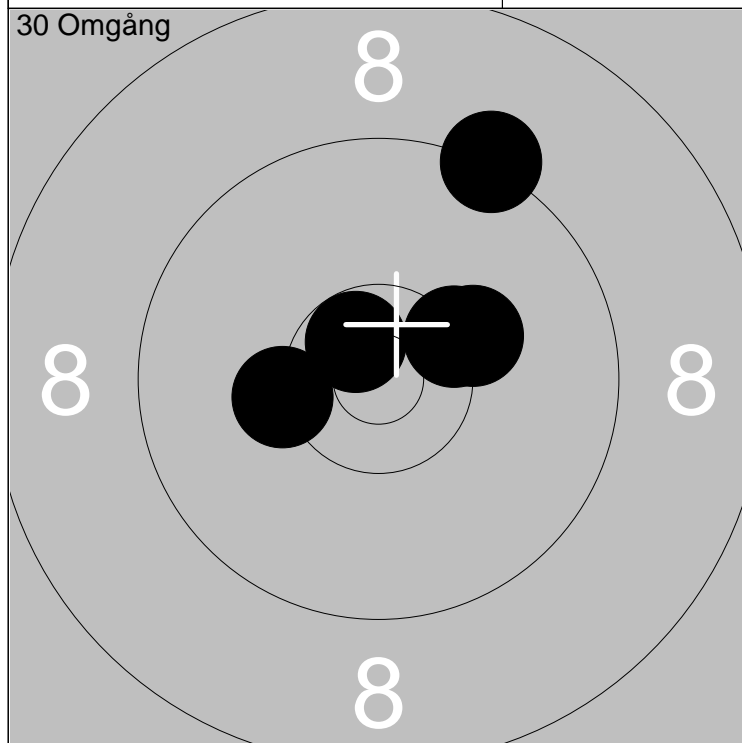

11: *10	↖
12: *10	↗
13: 9	↗
14: 10	→
15: 10	←

Serie	49
Total	148

16: 10	↘
17: 9	→
18: 9	↘
19: 10	↑
20: 9	↑

Serie	47
Total	195

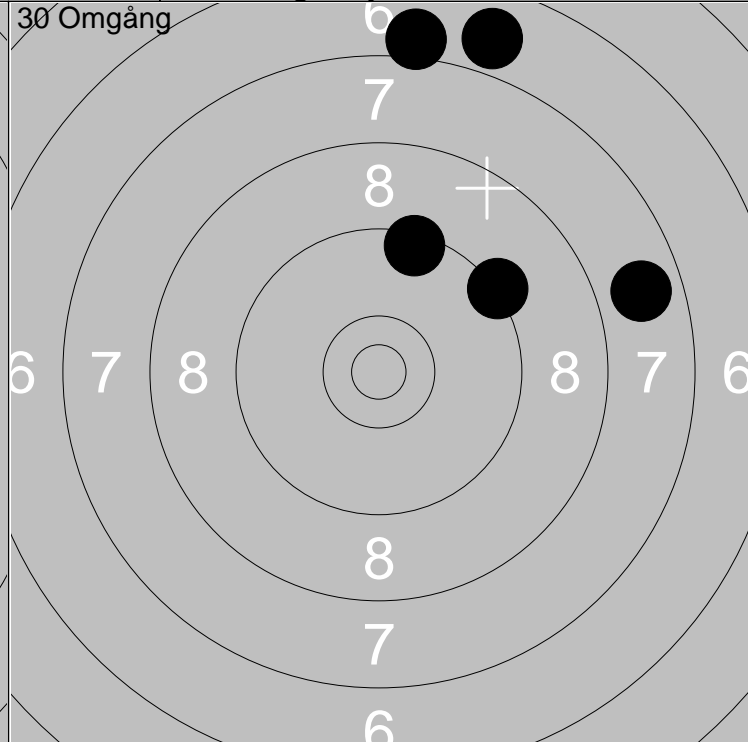
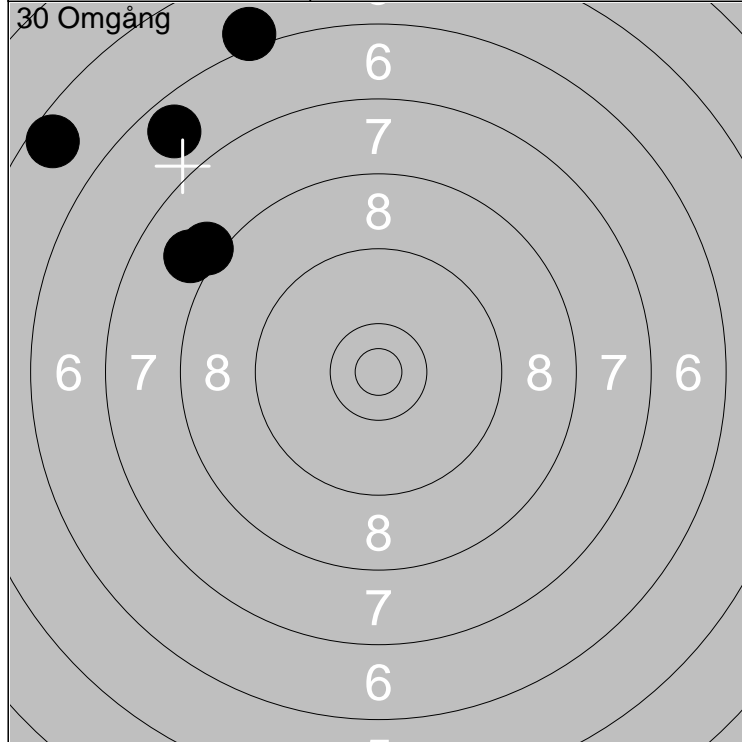

1: 8 ↗	Serie	33
2: 8 ↗		
3: 6 ↗	Total	33
4: 5 ↗		
5: 6 ↗		

6: 9 ↑	Serie	38
7: 9 ↗		
8: 7 →	Total	71
9: 6 ↑		
10: 7 ↑		

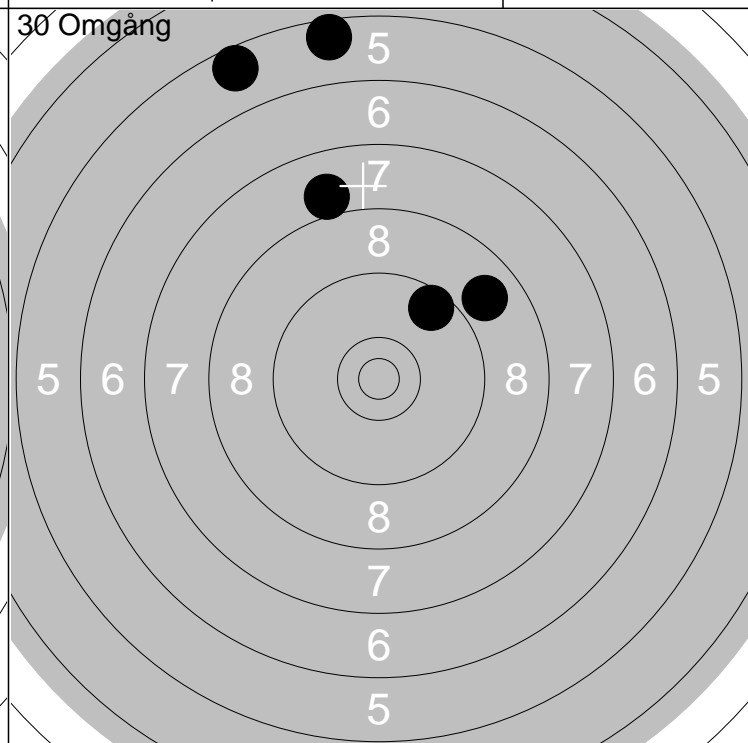
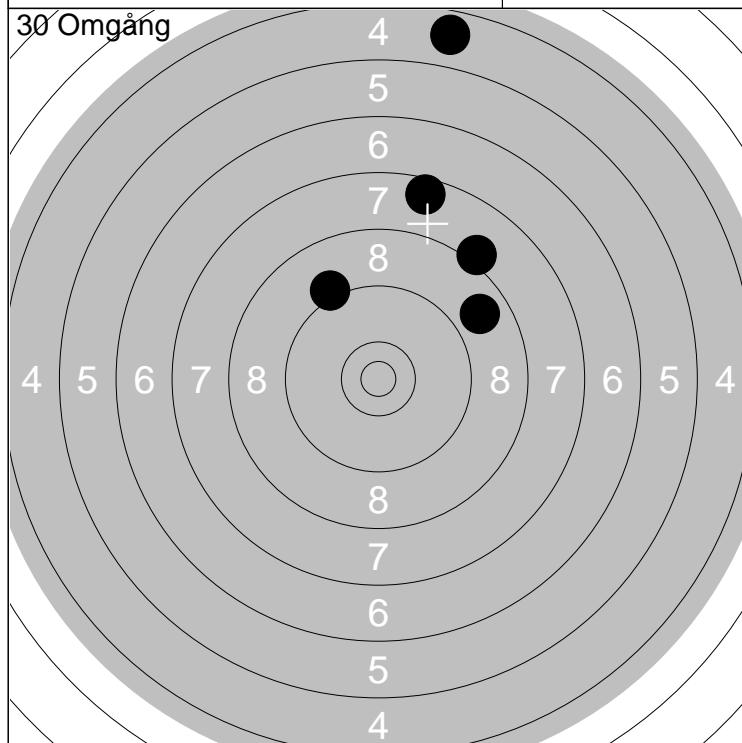

11: 7 ↑	Serie	36
12: 9 ↗		
13: 8 ↗	Total	107
14: 4 ↑		
15: 8 ↗		

16: 5 ↑	Serie	35
17: 9 ↗		
18: 8 ↑	Total	142
19: 5 ↗		
20: 8 ↗		

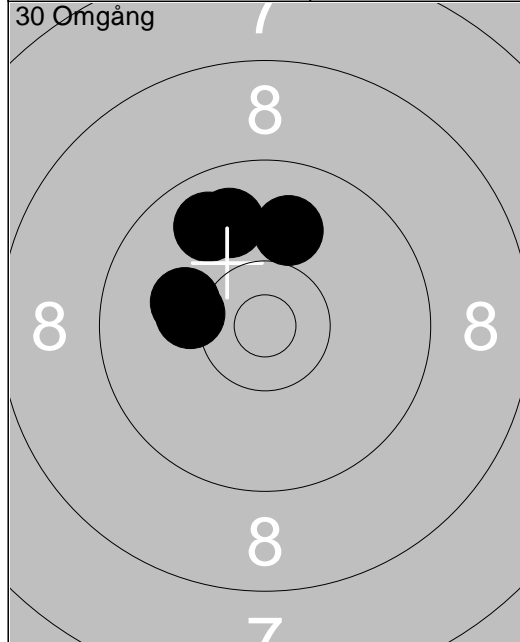

1: 10	←
2: 10	↑
3: 10	←
4: 9	↑
5: 9	↑
Serie 48	
Total 48	

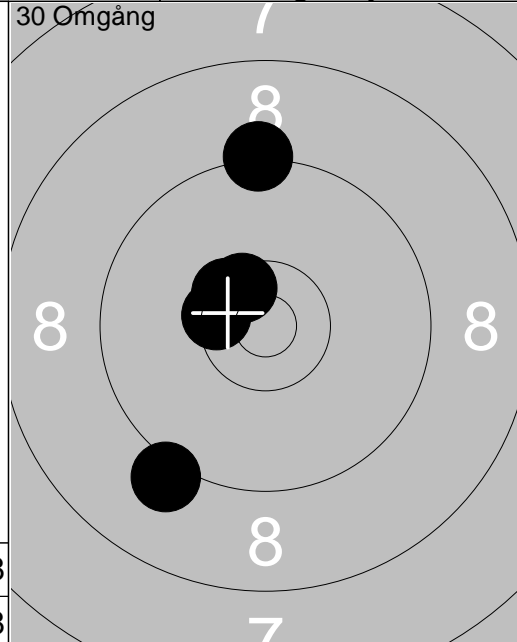

6: 9	↑
7: *10	↖
8: *10	←
9: *10	↖
10: 9	↘
Serie 48	
Total 96	

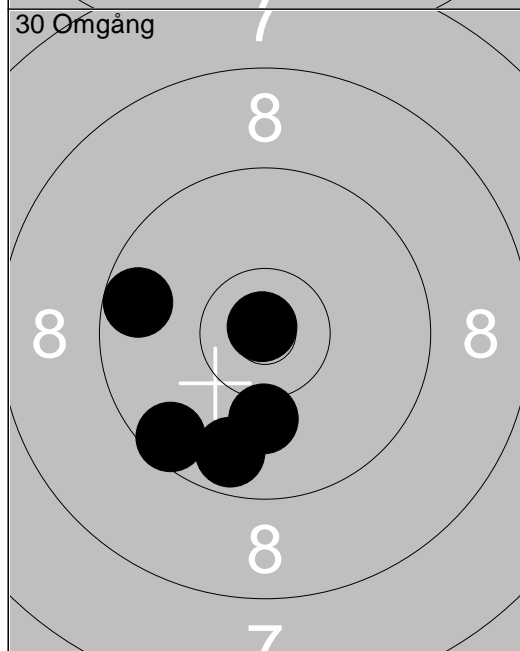

11: 9	↘
12: *10	↖
13: 10	↓
14: 9	←
15: 9	↘
Serie 47	
Total 143	

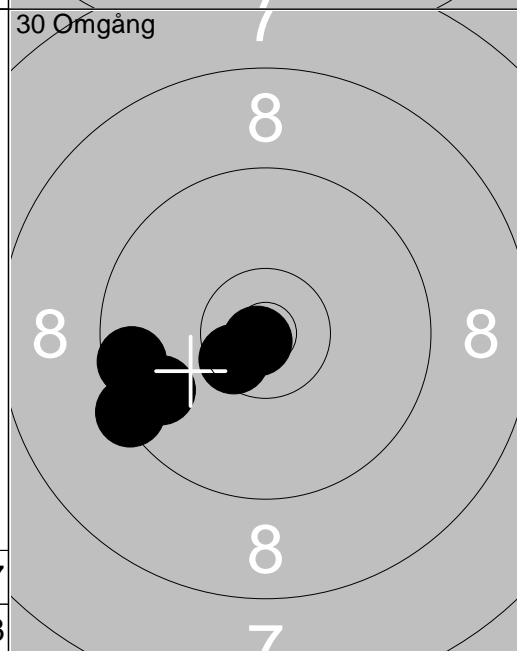

16: *10	↘
17: *10	↘
18: 9	↘
19: 9	←
20: 9	↘
Serie 47	
Total 190	

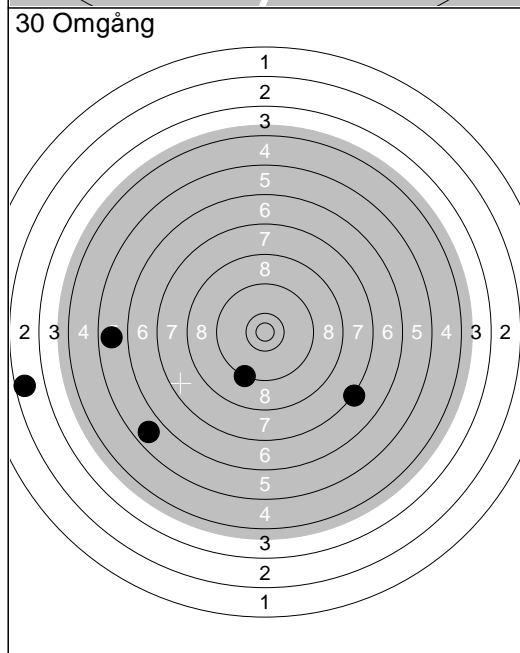

21: 5	↘
22: 2	←
23: 9	↘
24: 5	←
25: 7	↘
Serie 28	
Total 218	

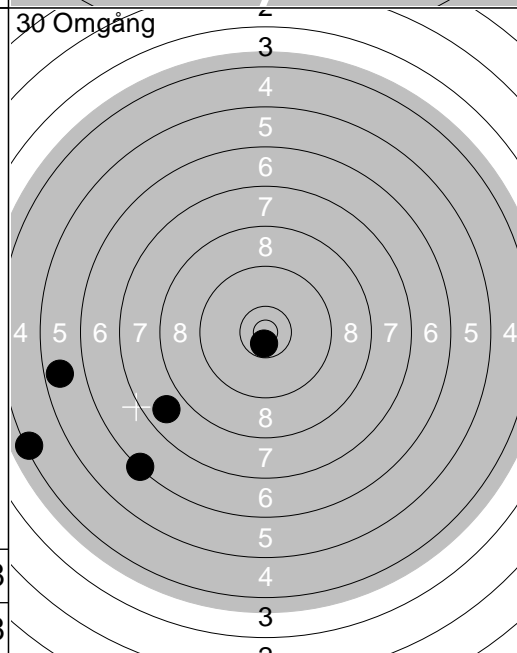

26: *10	↓
27: 7	↘
28: 5	←
29: 6	↘
30: 4	←
Serie 32	
Total 250	

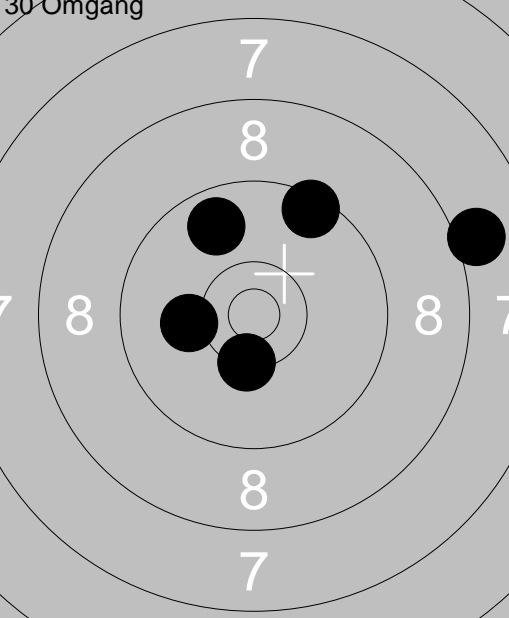
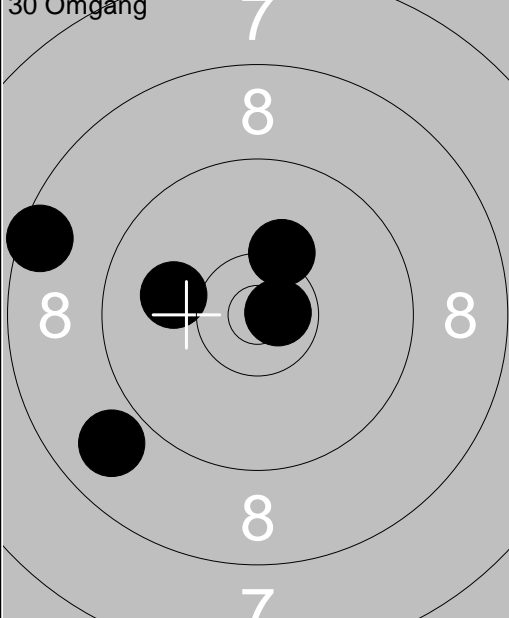
<p>30 Omgång</p> 	<p>1: *10 ↓ 2: 9 ↑ 3: 10 ← 4: 9 ↗ 5: 8 →</p>	<p>30 Omgång</p> 	<p>6: 8 ← 7: 10 ← 8: 8 ↙ 9: 10 ↗ 10: *10 →</p>
Serie 46	Total 46	Serie 46	Total 92

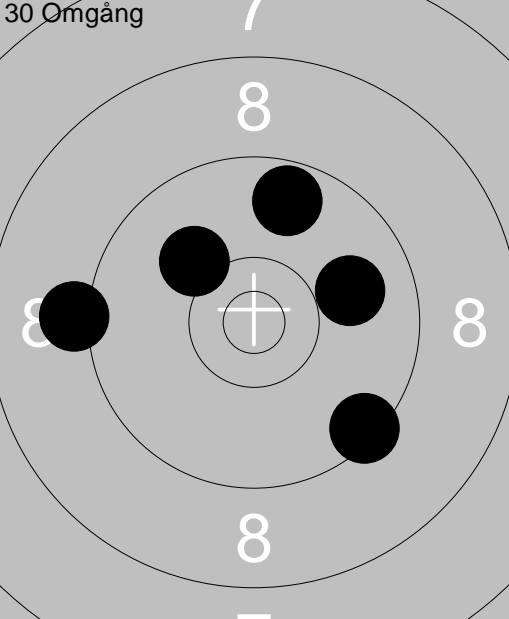
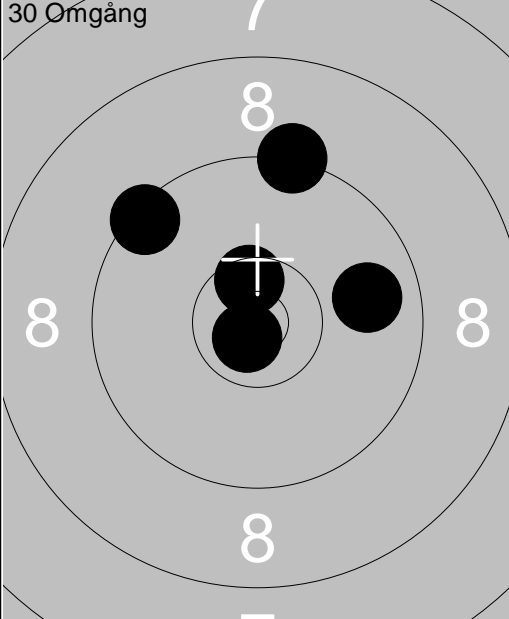
<p>30 Omgång</p> 	<p>11: 9 ← 12: 9 ↘ 13: 10 ↗ 14: 9 → 15: 9 ↑</p>	<p>30 Omgång</p> 	<p>16: 9 ↑ 17: 9 ← 18: *10 ↙ 19: 9 → 20: *10 ↑</p>
Serie 46	Total 138	Serie 47	Total 185

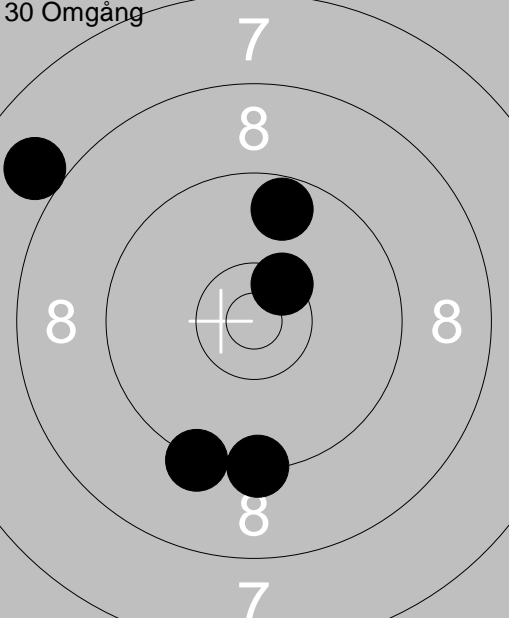
<p>30 Omgång</p> 	<p>21: 8 ← 22: 9 ↑ 23: *10 ↗ 24: 9 ↓ 25: 9 ↓</p>	<p>30 Omgång</p> 	<p>26: 10 → 27: 8 ↗ 28: 8 ↗ 29: 7 ← 30: 8 ↓</p>
Serie 45	Total 230	Serie 41	Total 271

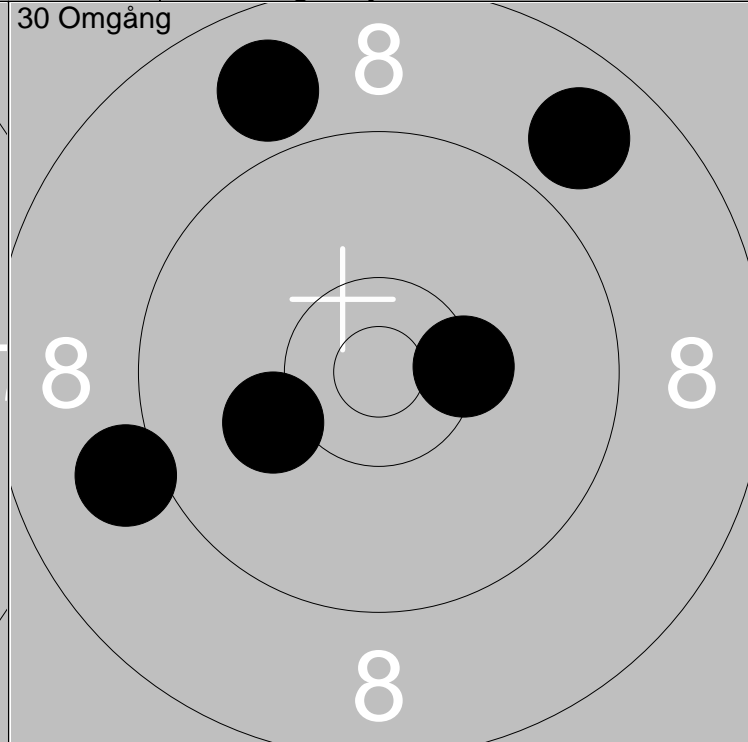
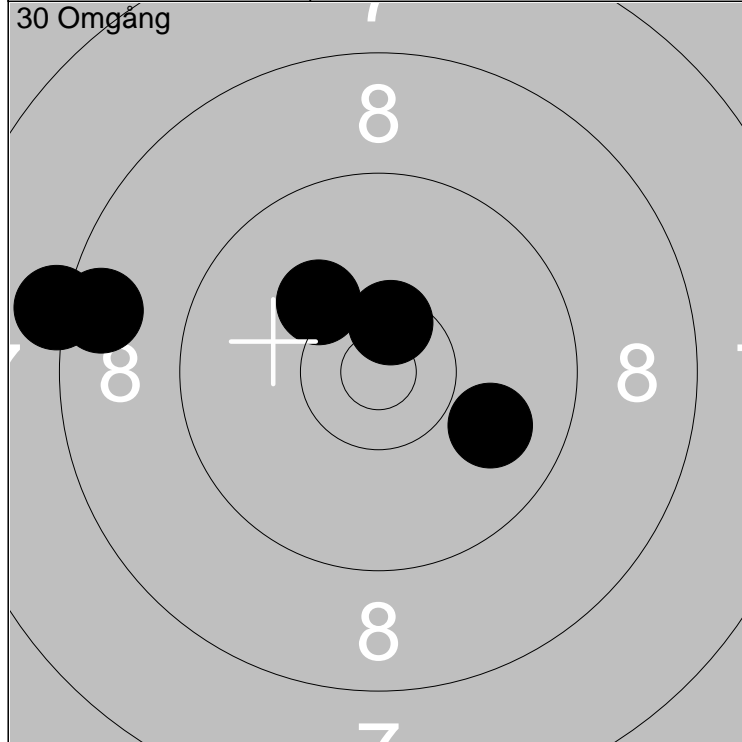

1: 8 ←	Serie	45
2: 10 ↗		
3: 9 ↘	Total	45
4: *10 ↑		
5: 8 ←		

6: 8 ↑	Serie	45
7: 10 ↙		
8: 8 ↗	Total	90
9: *10 →		
10: 9 ↙		

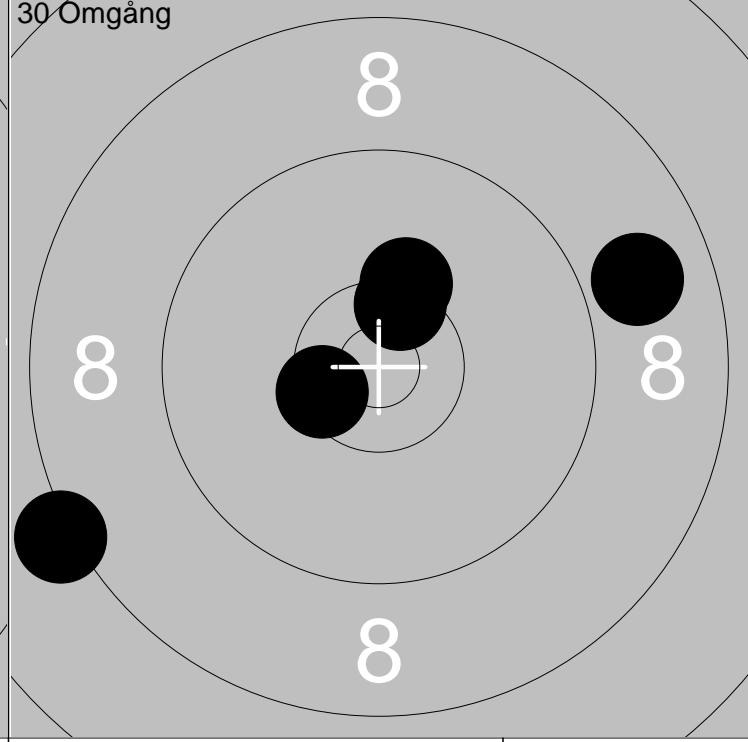
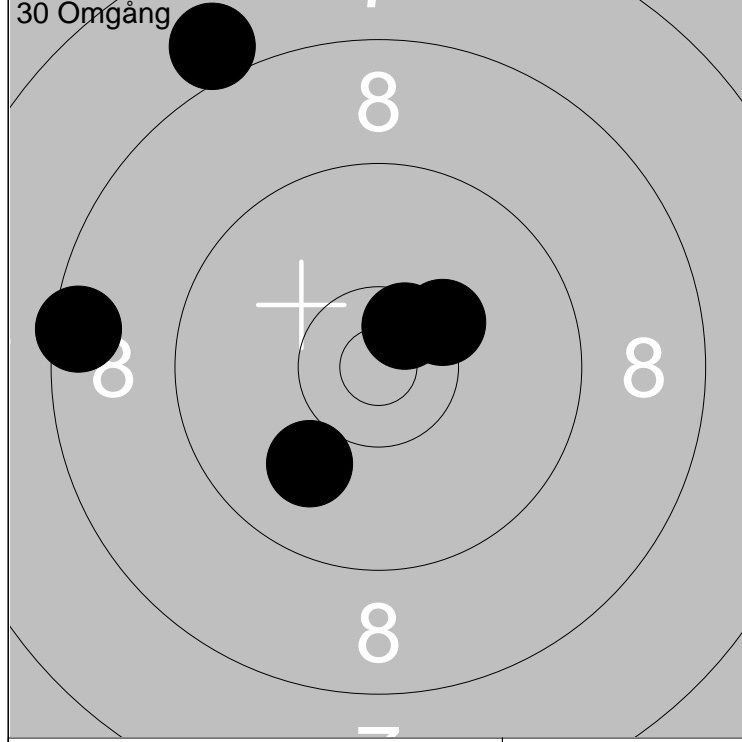

11: 8 ↗	Serie	46
12: 8 ←		
13: 10 ↘	Total	136
14: *10 ↗		
15: *10 ↗		

16: 8 ↙	Serie	46
17: 8 →		
18: *10 ↙	Total	182
19: 10 ↑		
20: *10 ↑		

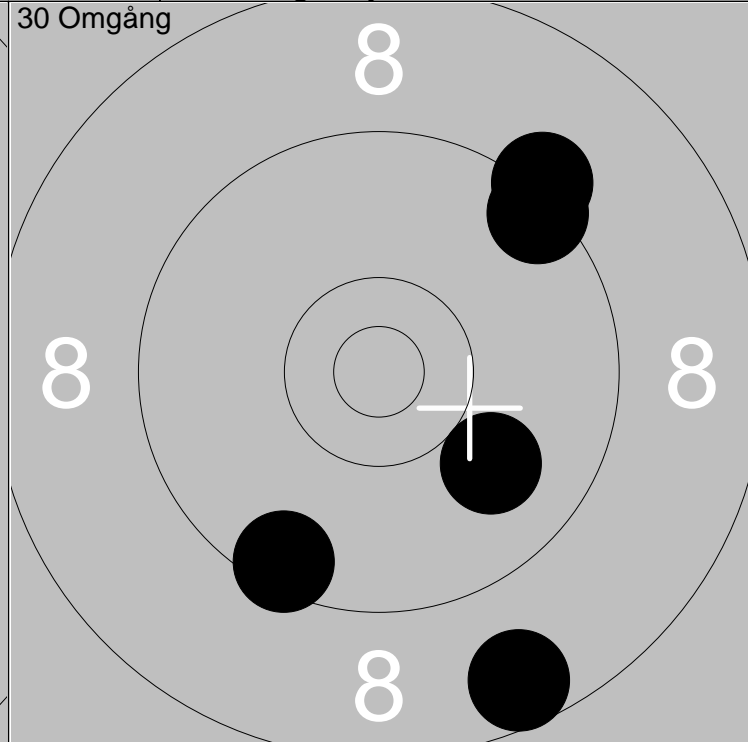
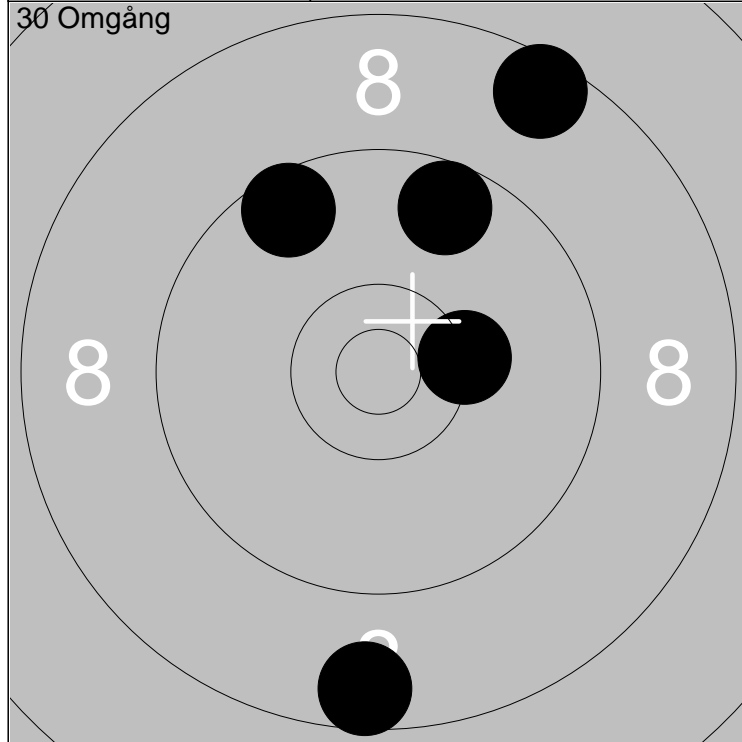

1: 9 ↗	Serie	44
2: 9 ↗		
3: 8 ↓	Total	44
4: 8 ↗		
5: *10 →		

6: 9 ↗	Serie	45
7: 8 ↓		
8: 9 ↓	Total	89
9: 9 ↗		
10: 10 ↓		

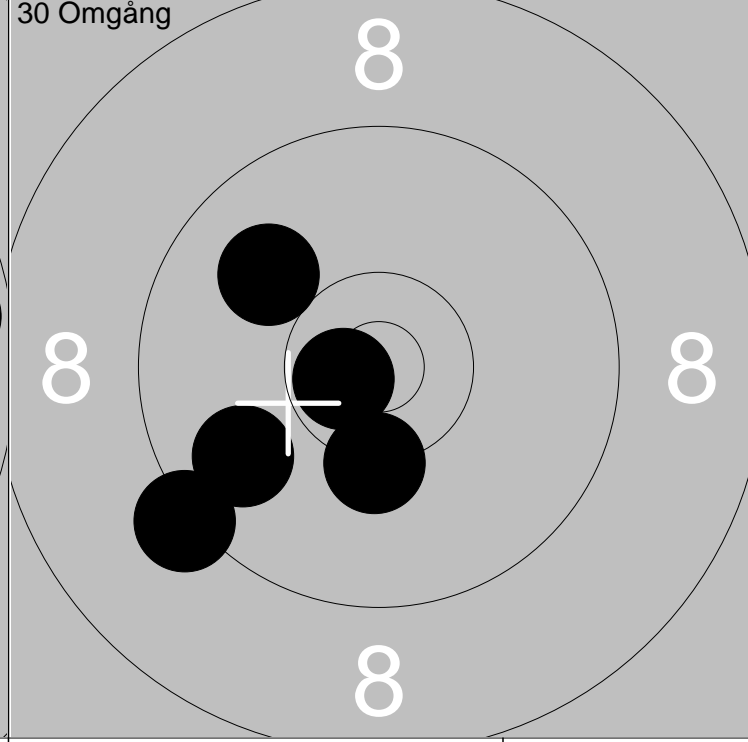
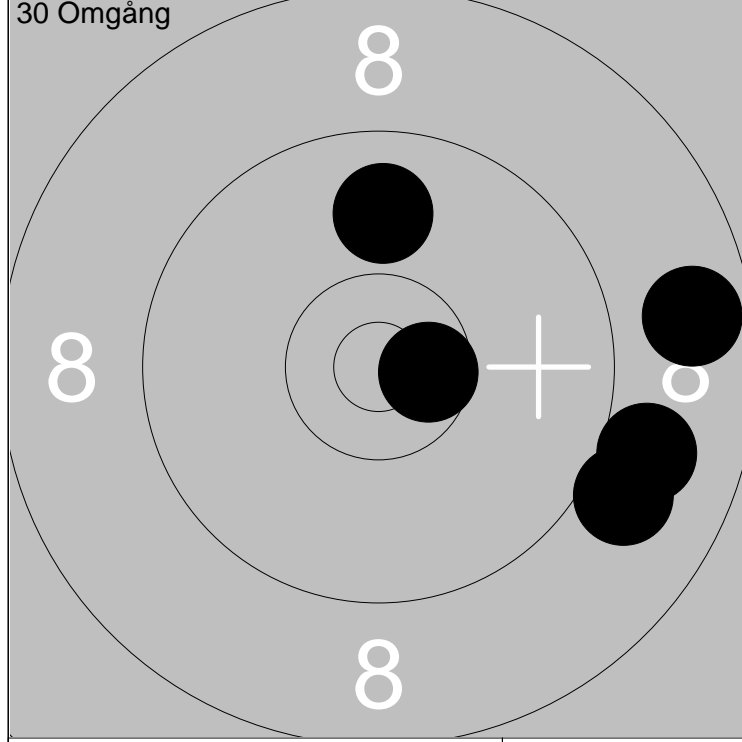

11: 9 ↓	Serie	45
12: *10 →		
13: 8 →	Total	134
14: 9 ↑		
15: 9 ↓		

16: 9 ←	Serie	48
17: *10 ↓		
18: 9 ←	Total	182
19: *10 ←		
20: 10 ↗		

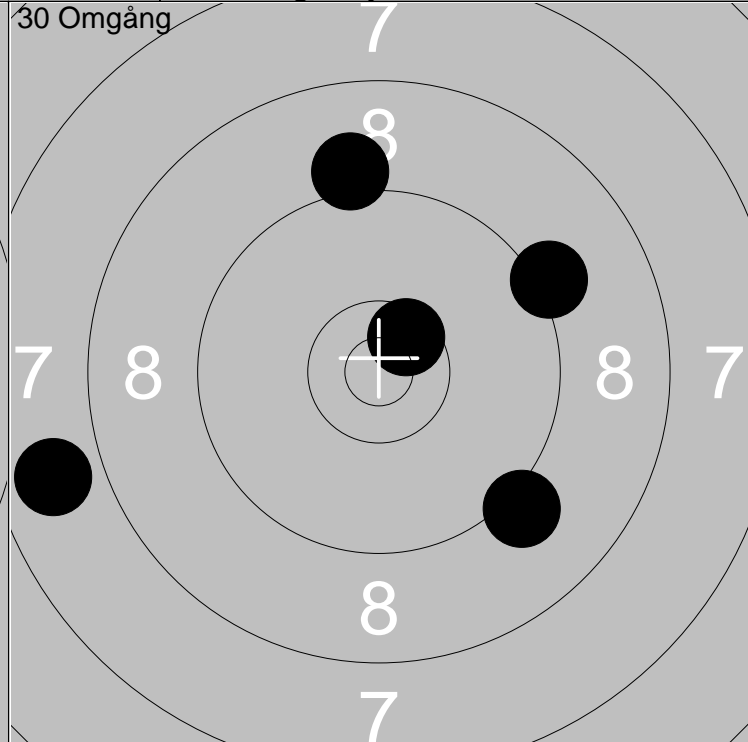
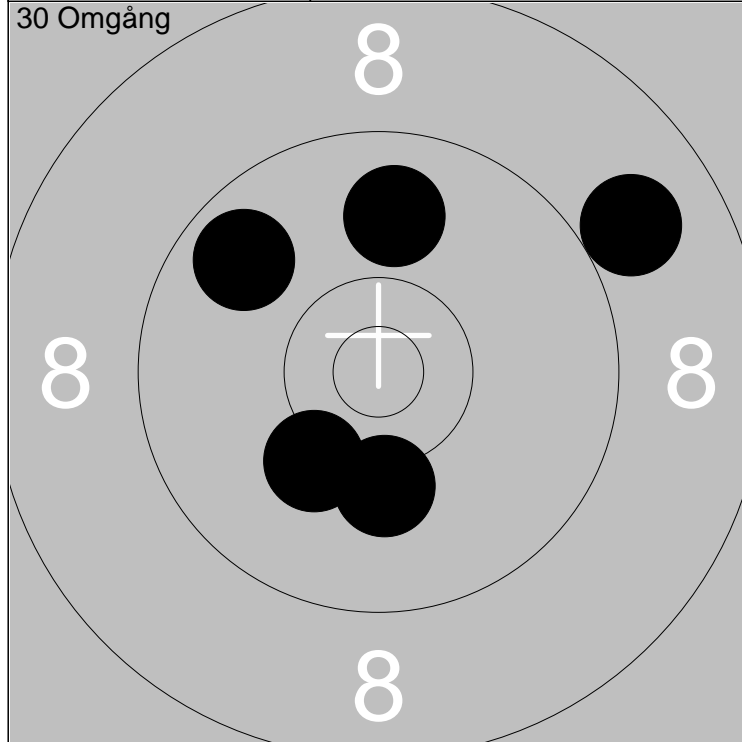

1: 10	↙
2: 9	↖
3: 8	↗
4: 9	↑
5: 10	↓

Serie	46
Total	46

6: 7	←
7: *10	↗
8: 9	↘
9: 9	↑
10: 9	↗

Serie	44
Total	90

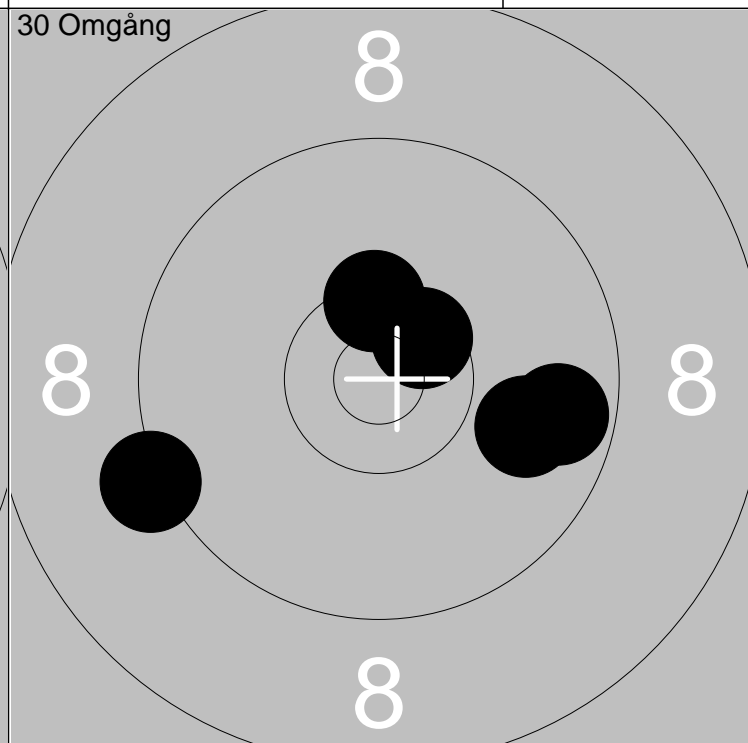
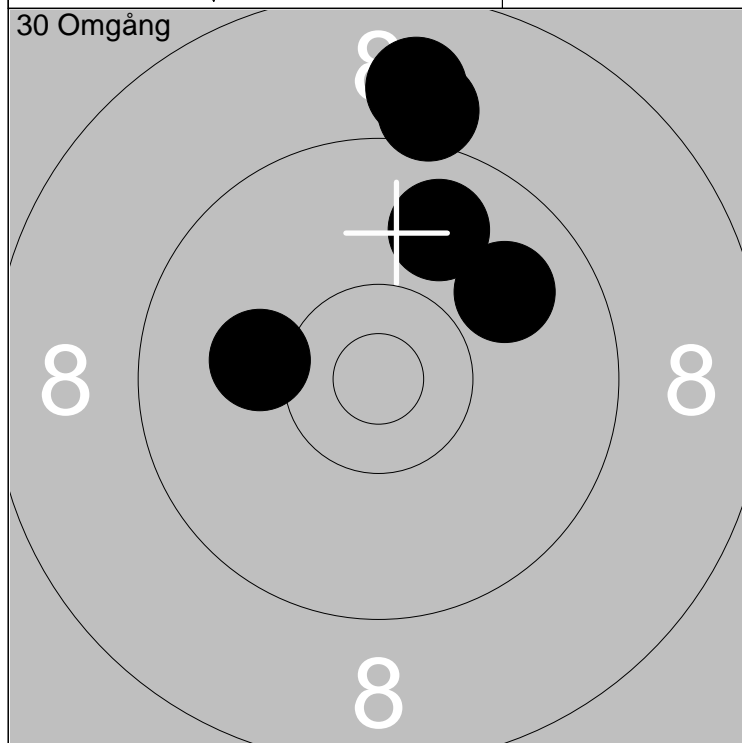

11: 9	↑
12: 10	←
13: 9	↗
14: 8	↑
15: 9	↗

Serie	45
Total	135

16: *10	↗
17: 9	→
18: 9	→
19: *10	↑
20: 9	←

Serie	47
Total	182

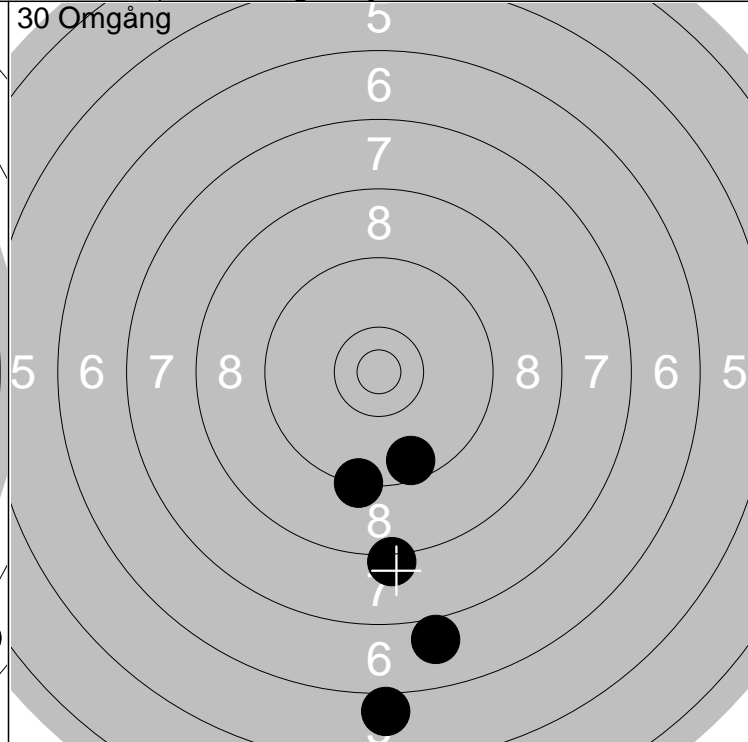
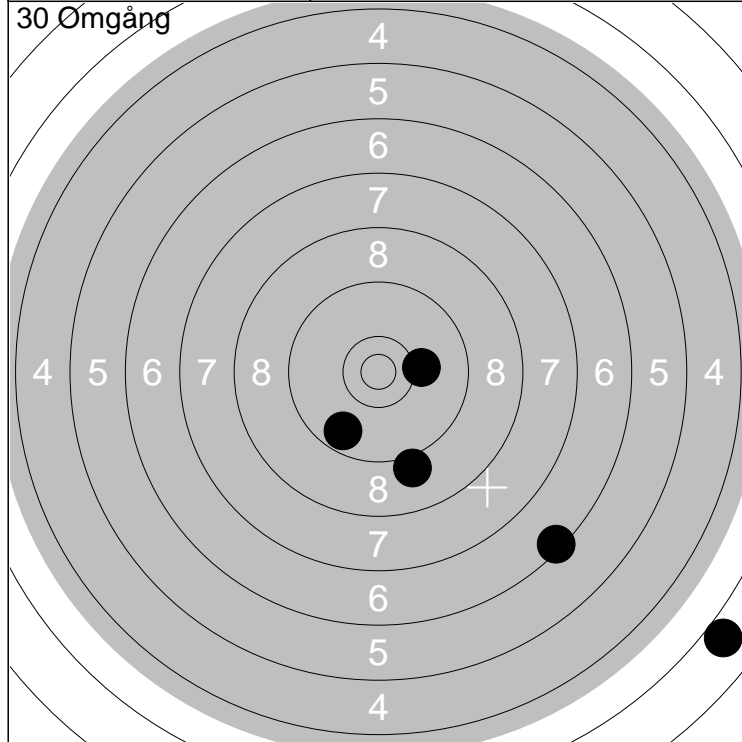

1: 9	↘	Serie	37
2: 9	↘		
3: 3	↘	Total	37
4: 6	↘		
5: 10	→		

6: 7	↘	Serie	39
7: 9	↘		
8: 9	↘	Total	76
9: 8	↘		
10: 6	↘		

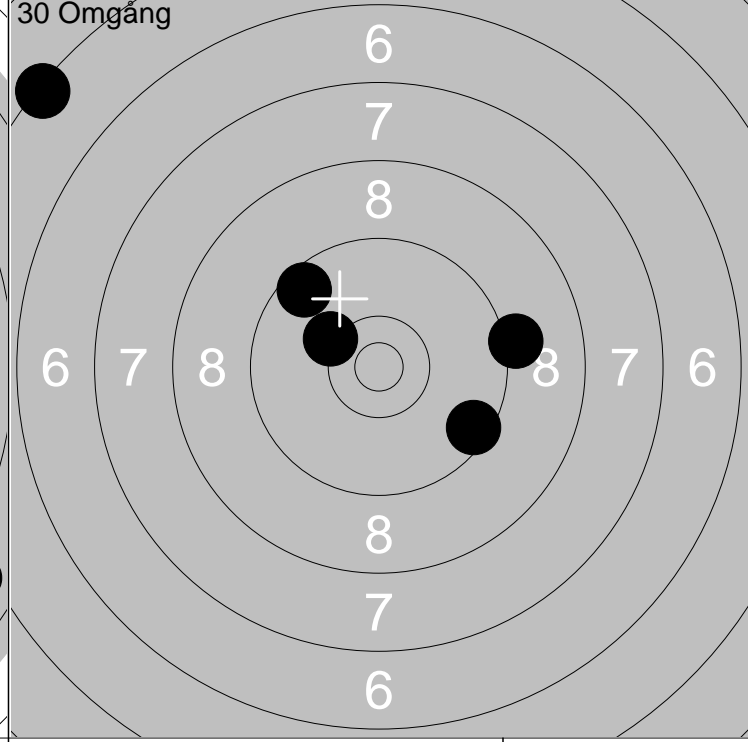
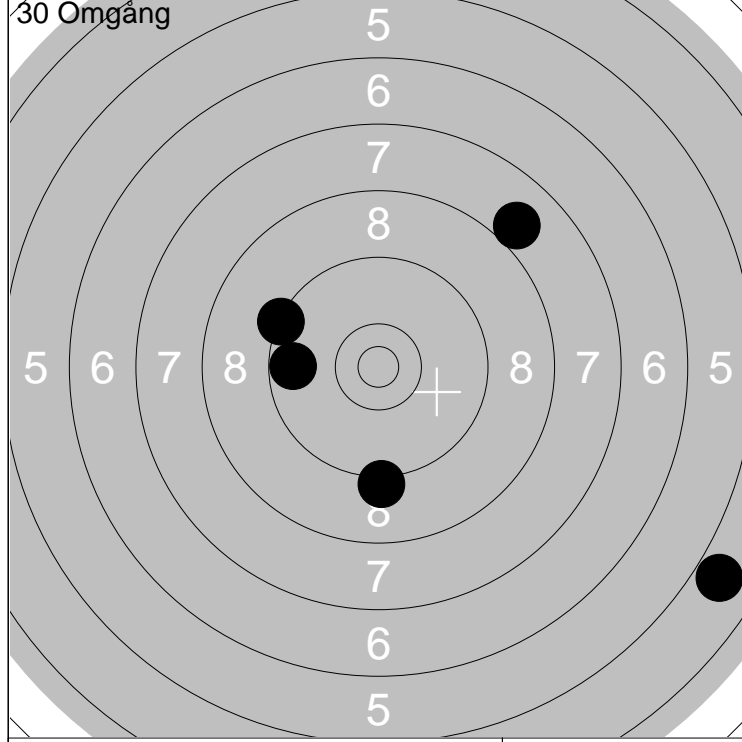

11: 9	↓	Serie	39
12: 9	←		
13: 4	↘	Total	115
14: 8	↗		
15: 9	↖		

16: 10	↖	Serie	42
17: 5	↗		
18: 9	↗	Total	157
19: 9	→		
20: 9	↘		

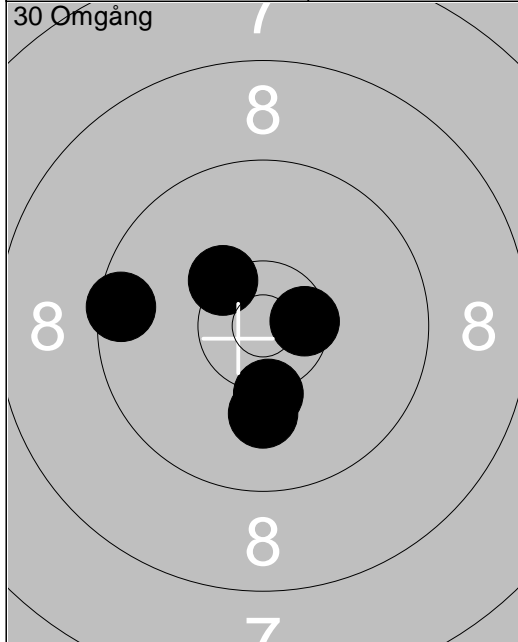

1: 10	↓
2: 10	↓
3: *10	→
4: 9	←
5: *10	↗
Serie 49	
Total 49	

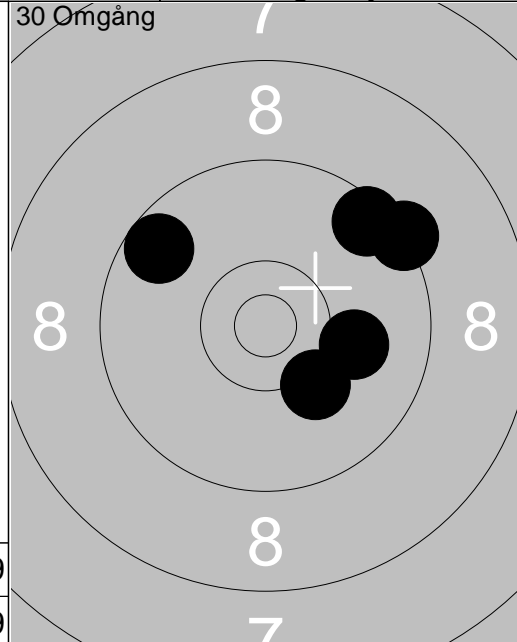

6: 9	↗
7: 9	↗
8: 9	↖
9: 10	↓
10: 10	→
Serie 47	
Total 96	

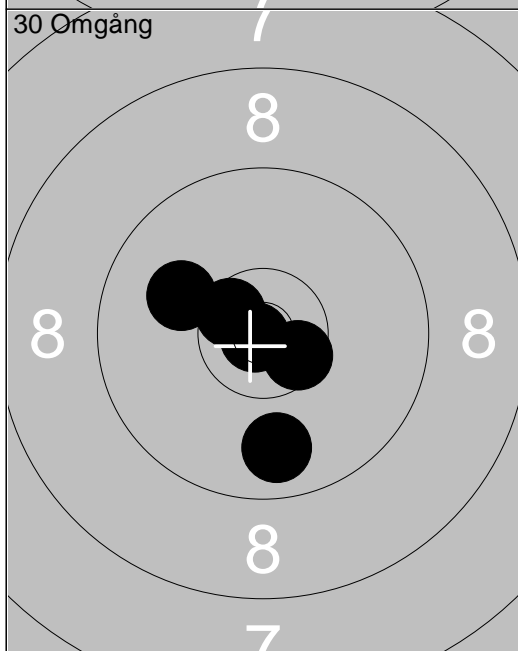

11: *10	↘
12: 9	↓
13: 10	↖
14: *10	↖
15: *10	←
Serie 49	
Total 145	

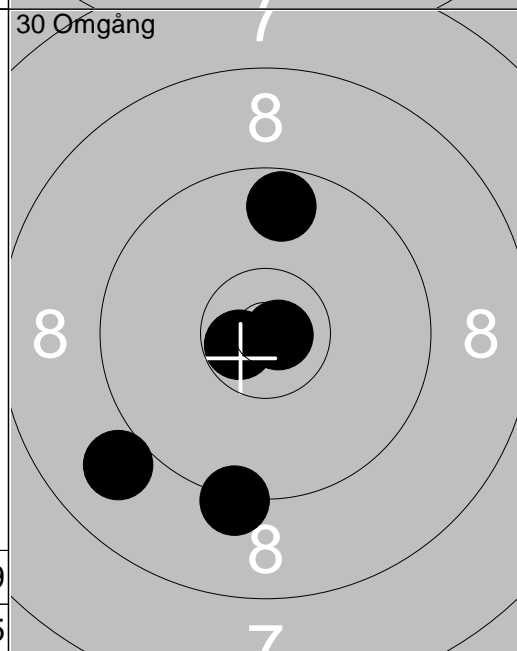

16: 9	↑
17: 9	↖
18: *10	←
19: *10	→
20: 9	↓
Serie 47	
Total 192	

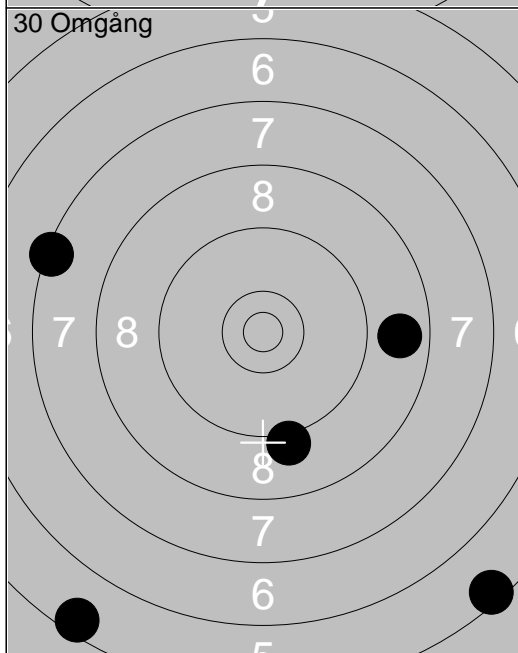

21: 9	↓
22: 5	↓
23: 7	↖
24: 8	→
25: 5	↘
Serie 34	
Total 226	

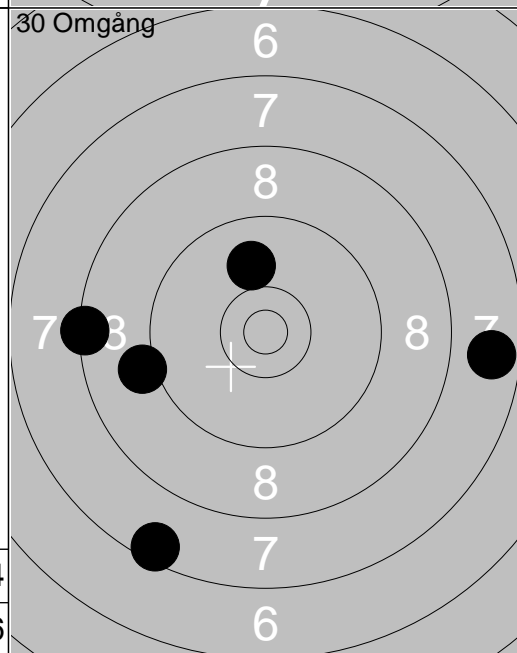

26: 7	→
27: 8	←
28: 9	←
29: 7	↘
30: 10	↑
Serie 41	
Total 267	

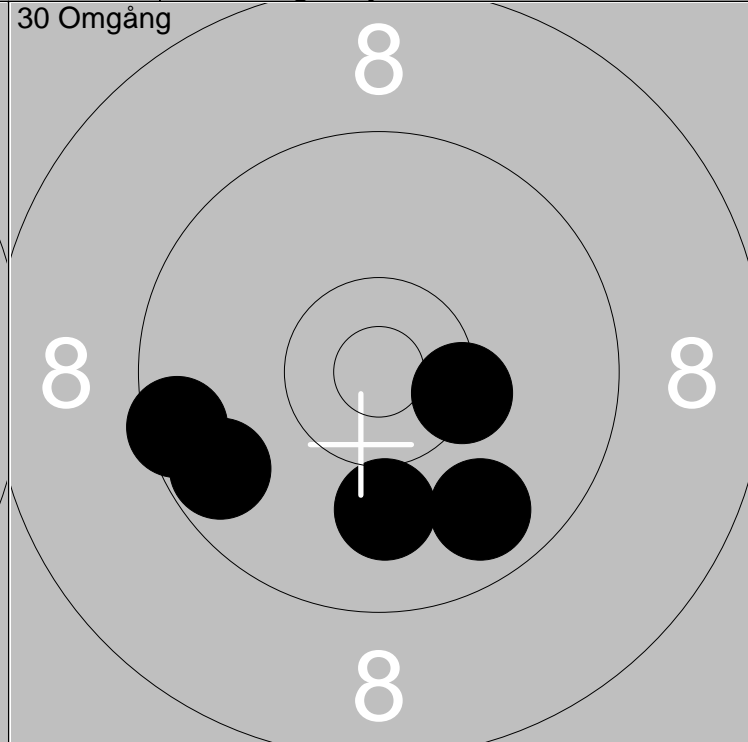
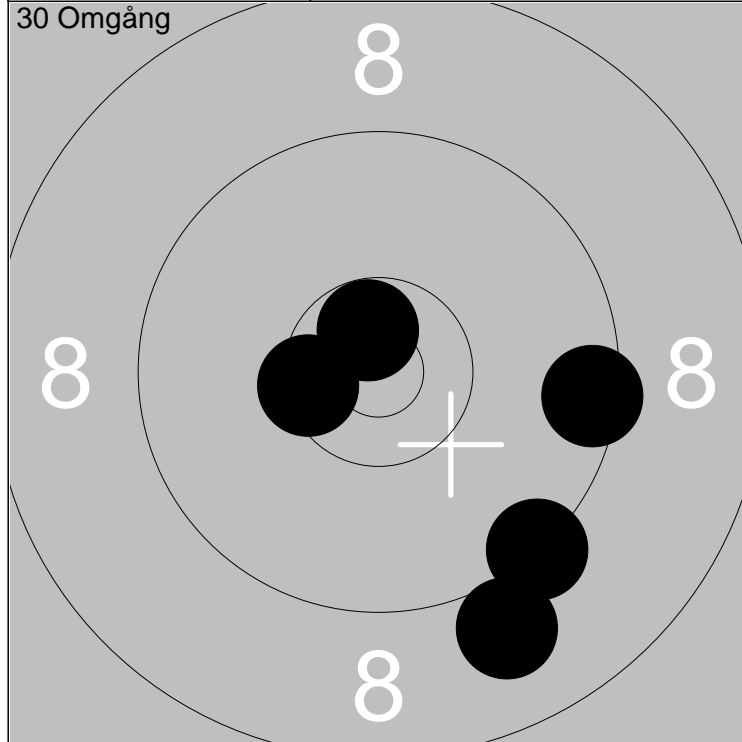

1: 9 ↘	Serie	47
2: *10 ←		Total
3: *10 ↗		
4: 9 →		
5: 9 ↘		

6: 9 ←	Serie	47
7: 9 ↘		Total
8: *10 →		
9: 10 ↓		
10: 9 ↙		

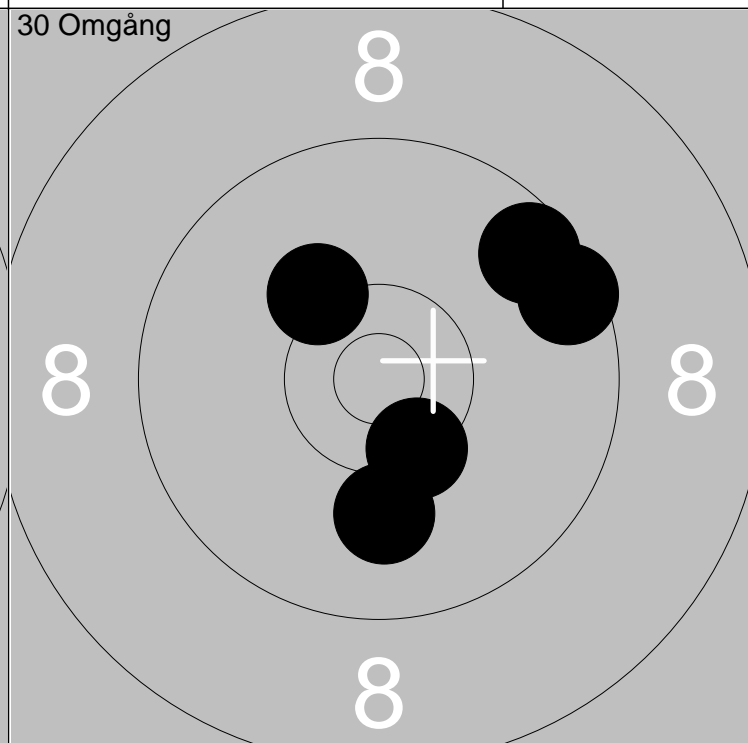
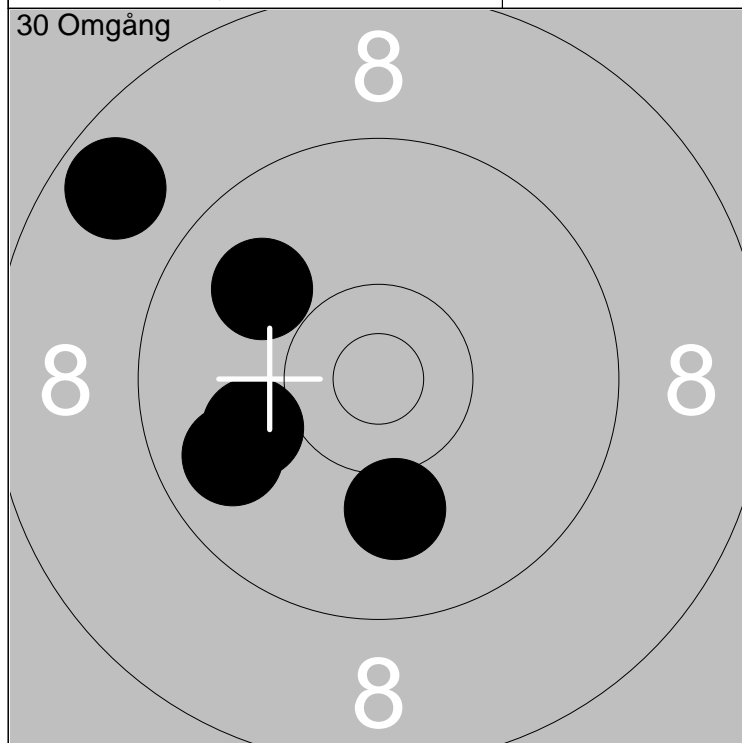

11: 10 ↓	Serie	46
12: 10 ←		Total
13: 8 ↗		
14: 9 ←		
15: 9 ↗		

16: 10 ↓	Serie	48
17: 9 →		Total
18: 10 ↗		
19: 9 ↗		
20: *10 ↓		

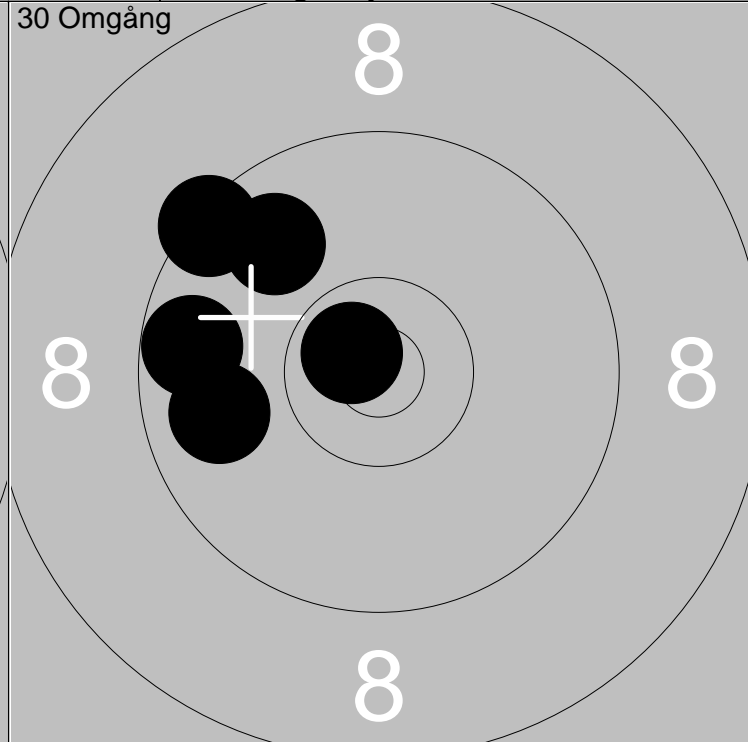
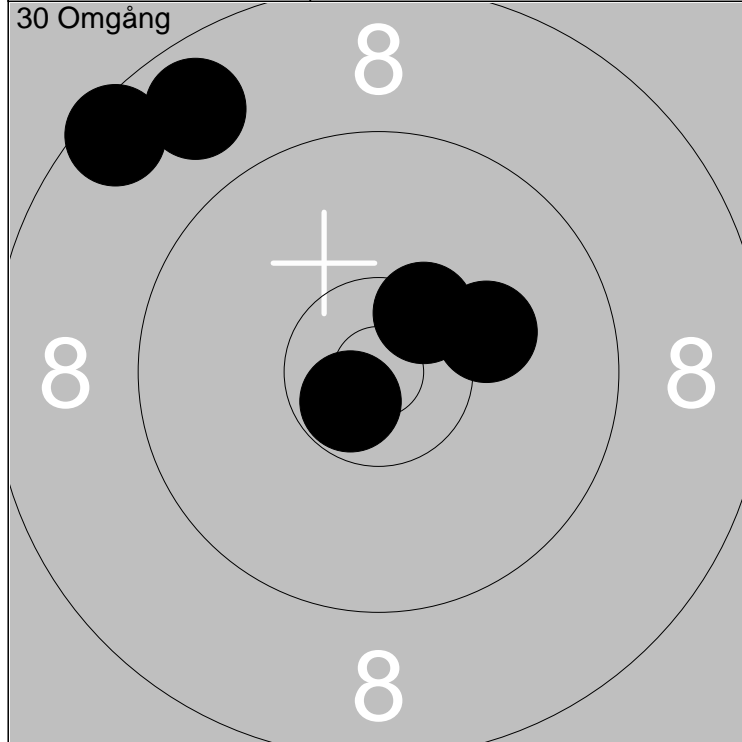

1: *10 ↗
2: 10 →
3: 8 ↗
4: 8 ↗
5: *10 ↘

Serie	46
Total	46

6: *10 ↗
7: 9 ↗
8: 9 ↗
9: 9 ←
10: 9 ←

Serie	46
Total	92

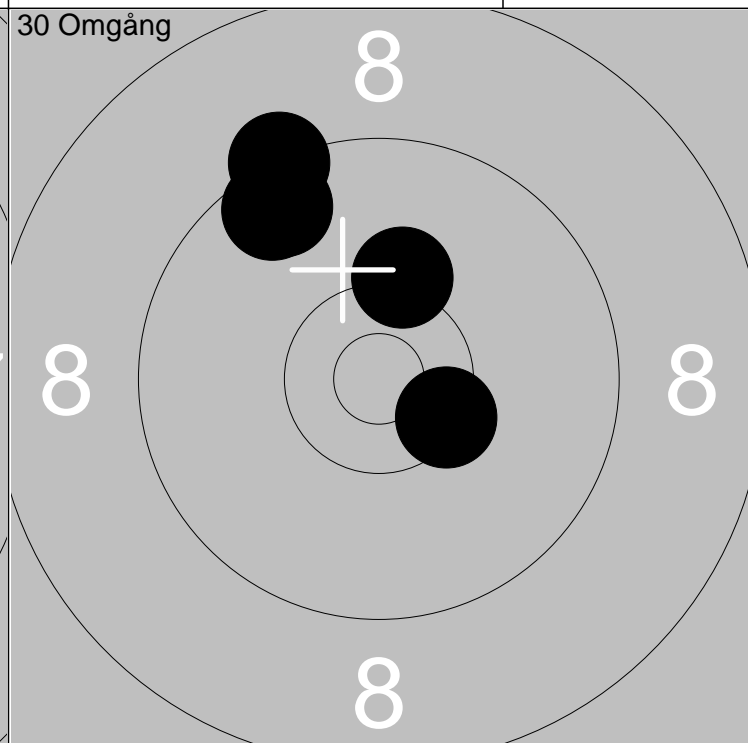
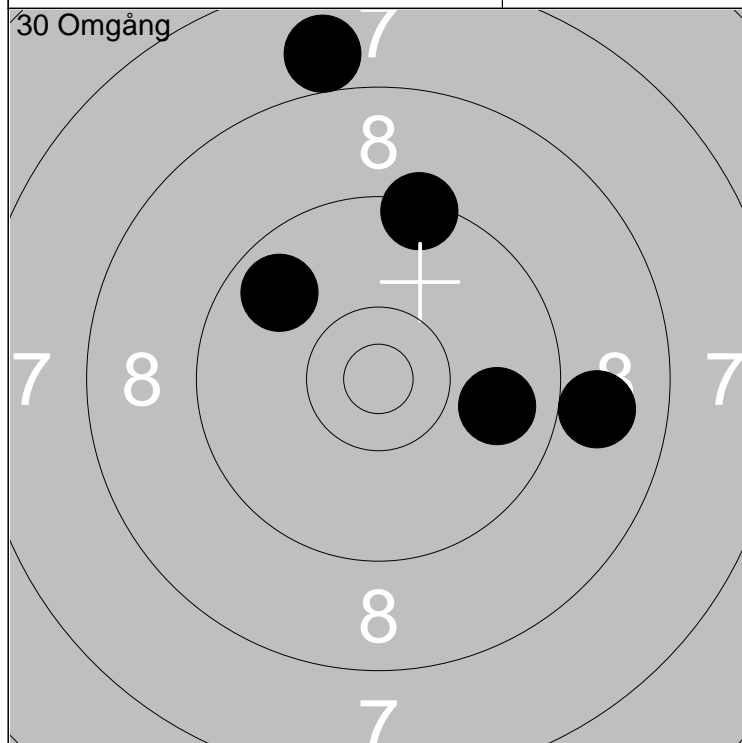

11: 9 →
12: 8 ↑
13: 9 ↑
14: 9 ↗
15: 8 →

Serie	43
Total	135

16: 10 ↑
17: 9 ↗
18: 9 ↗
19: 9 ↗
20: *10 ↘

Serie	47
Total	182

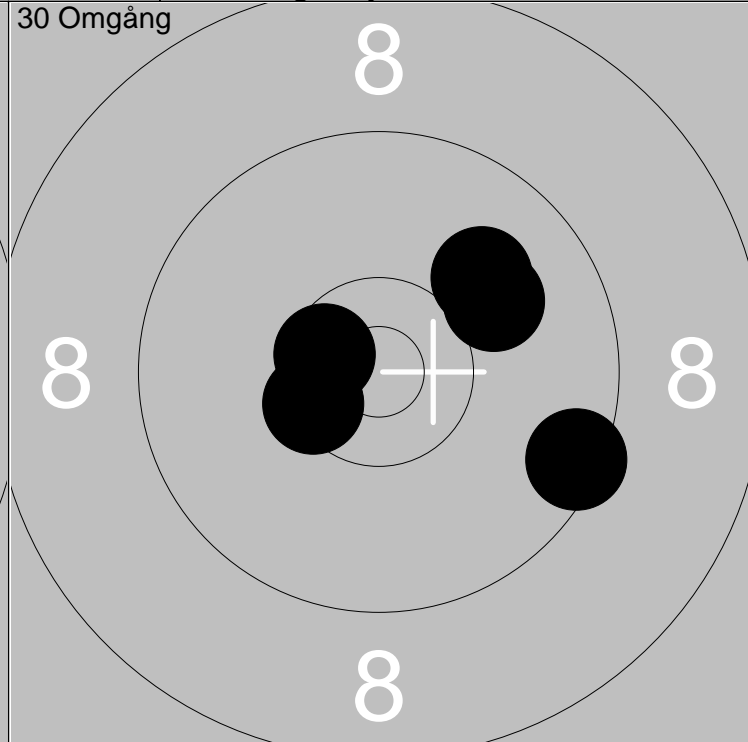
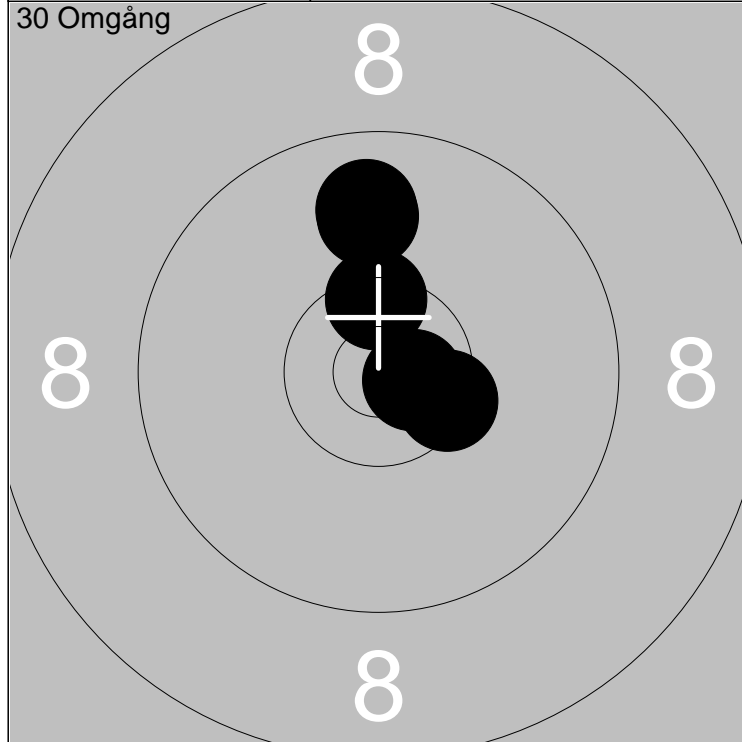

1: 9	↑
2: *10	→
3: *10	→
4: *10	↑
5: 9	↑

Serie	48
Total	48

6: 9	→
7: 10	↗
8: *10	←
9: 10	↗
10: *10	←

Serie	49
Total	97

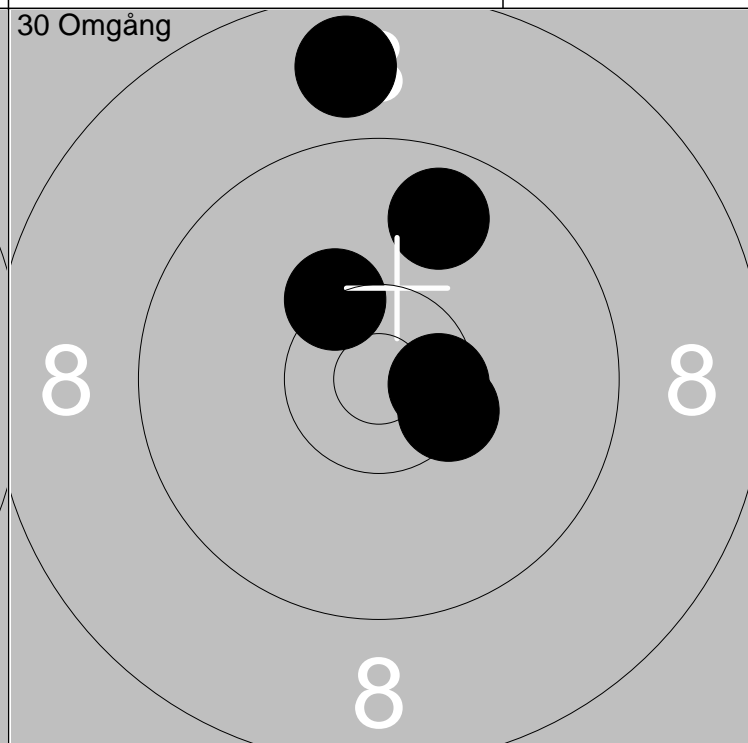
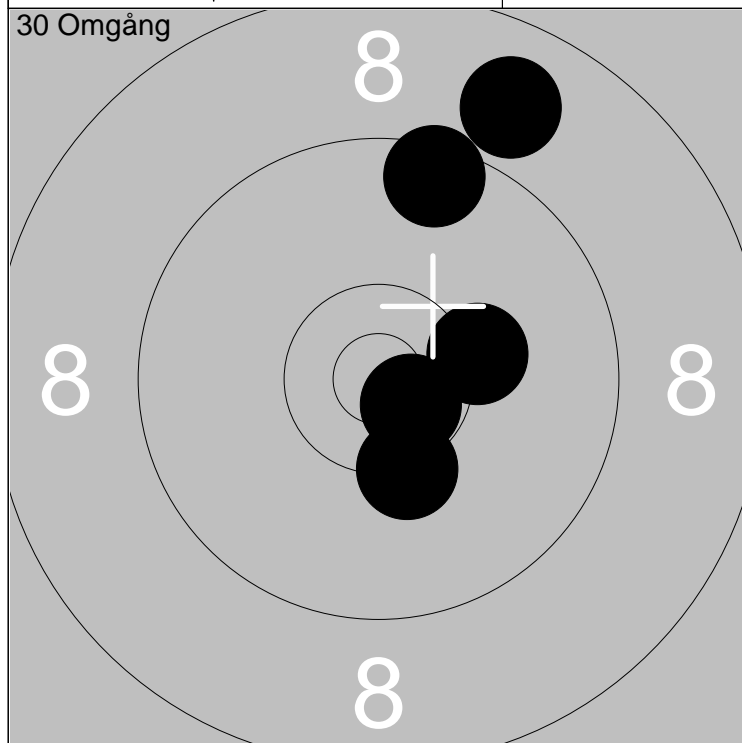

11: *10	↓
12: 8	↗
13: 9	↑
14: *10	→
15: 10	→

Serie	47
Total	144

16: 9	↑
17: *10	→
18: *10	→
19: *10	↗
20: 8	↑

Serie	47
Total	191

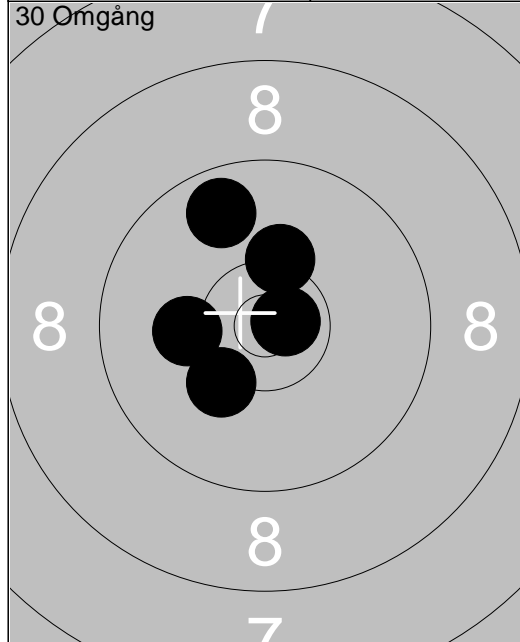

1: 10 ↙
2: 10 ←
3: 9 ↗
4: 10 ↑
5: *10 →
Serie 49
Total 49

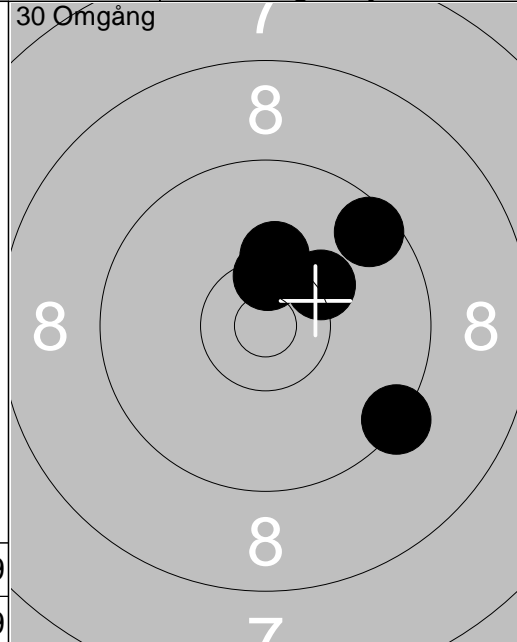

6: 10 ↗
7: 9 ↗
8: *10 ↑
9: 10 ↑
10: 9 ↘
Serie 48
Total 97

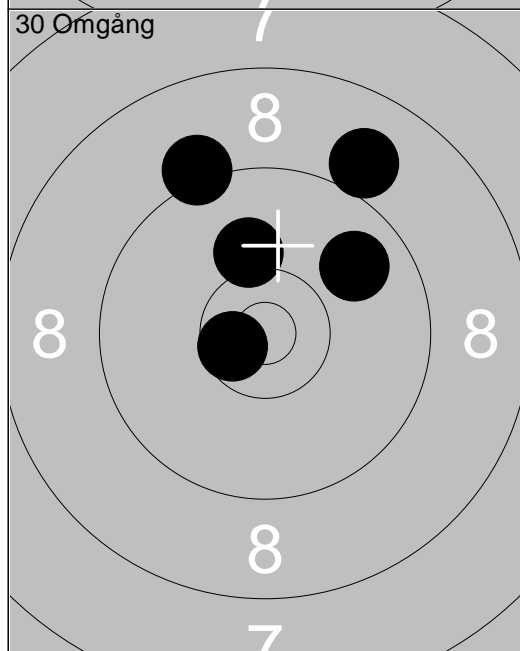

11: *10 ←
12: 9 ↗
13: 10 ↑
14: 9 ↗
15: 9 ↗
Serie 47
Total 144

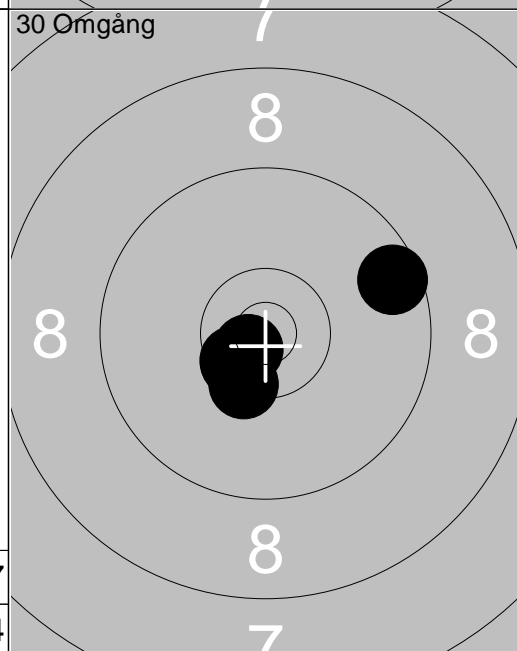

16: 9 ↗
17: *10 ↙
18: *10 ↙
19: *10 ↙
20: *10 ↙
Serie 49
Total 193

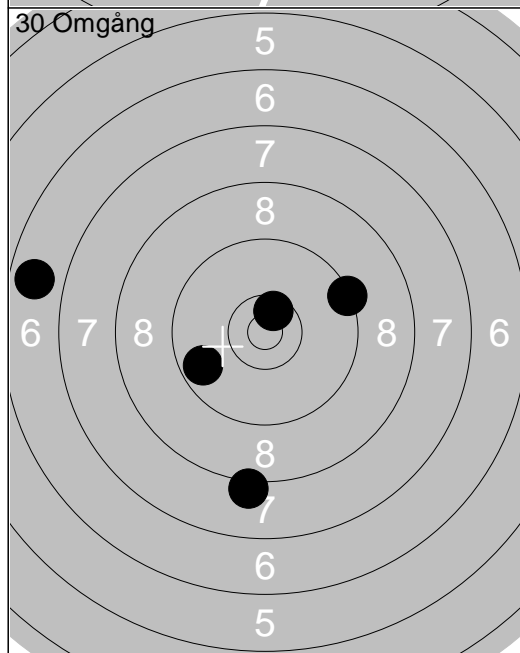

21: 8 ↓
22: 6 ←
23: 9 ←
24: 9 →
25: *10 ↑
Serie 42
Total 235

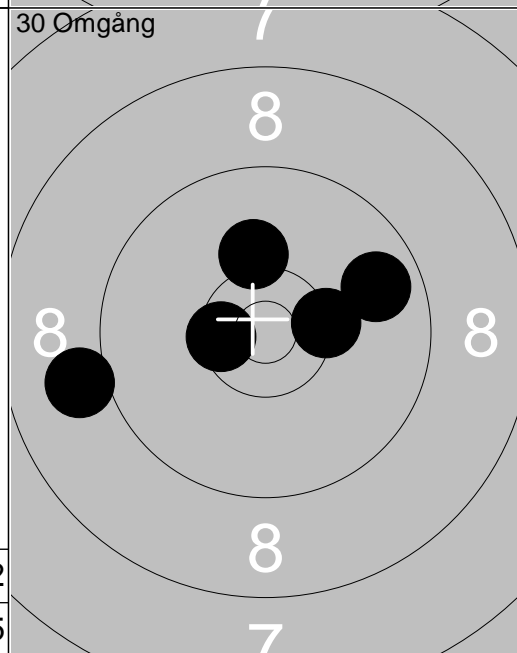

26: 9 ←
27: 9 →
28: 10 ↑
29: *10 →
30: *10 ←
Serie 48
Total 283

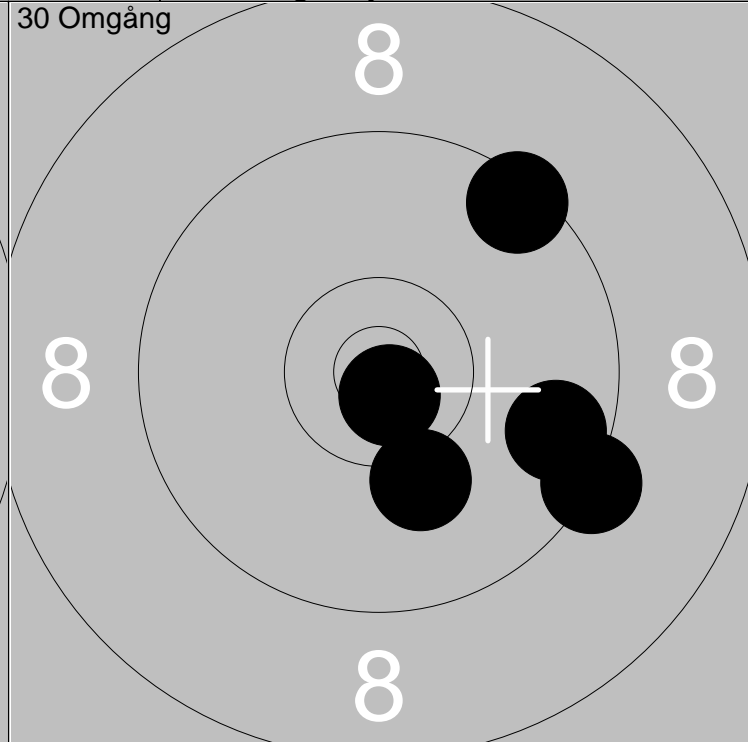
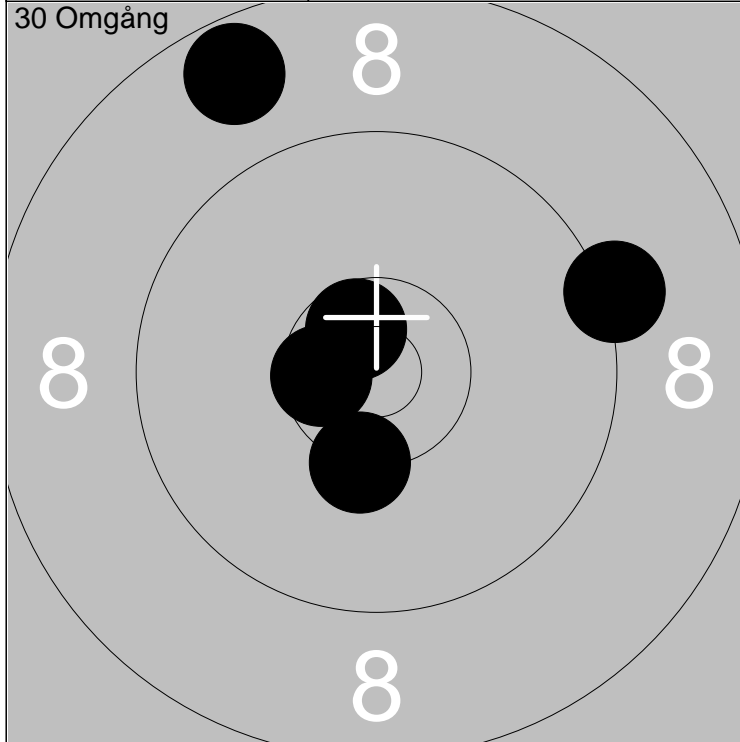

1: *10 ↓	Serie	47
2: 8 ↗		
3: 9 →	Total	47
4: *10 ←		
5: *10 ↖		

6: 9 →	Serie	47
7: *10 ↓		
8: 9 ↗	Total	94
9: 9 →		
10: 10 ↓		

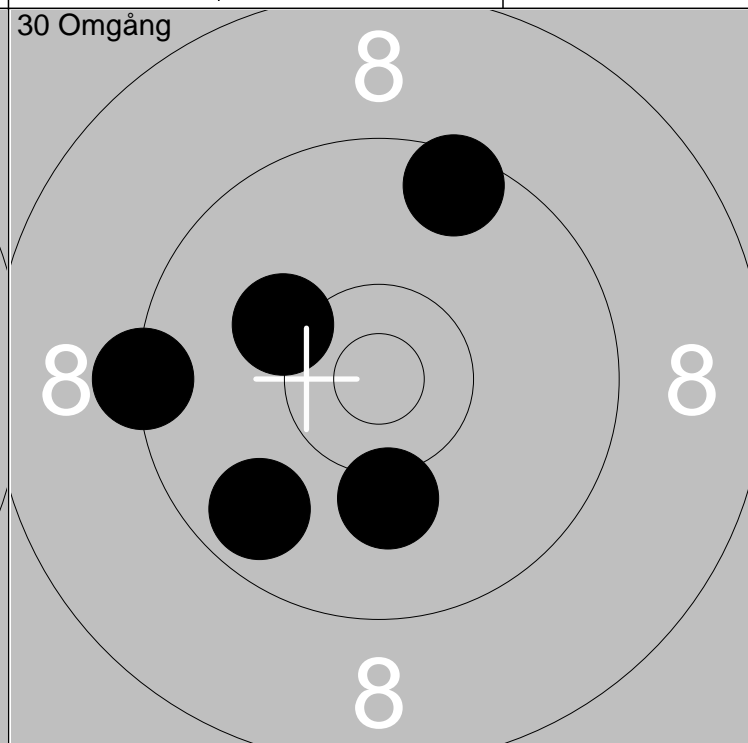
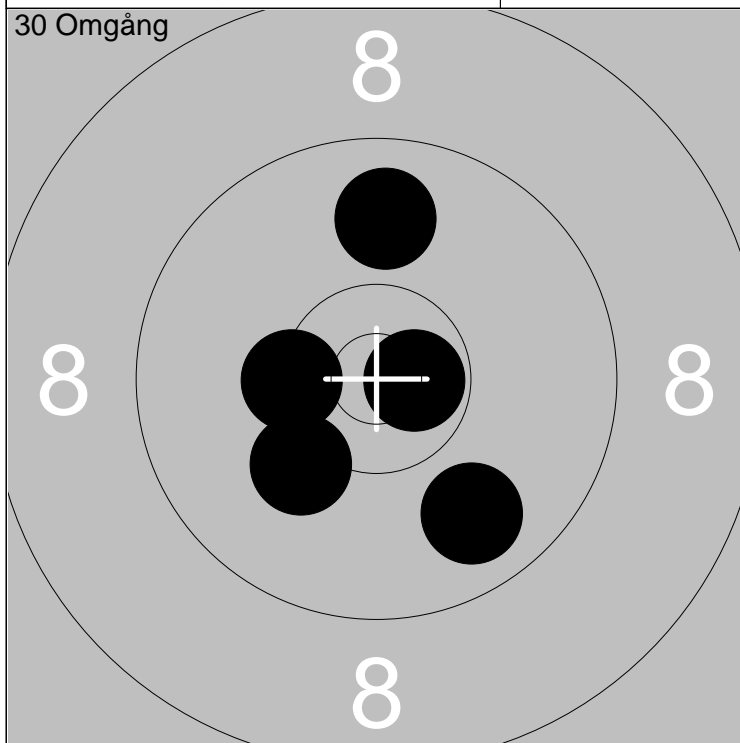

11: 9 ↑	Serie	48
12: *10 ←		
13: 9 ↓	Total	142
14: *10 →		
15: 10 ↙		

16: 10 ↖	Serie	47
17: 9 ↓		
18: 10 ↓	Total	189
19: 9 ←		
20: 9 ↗		

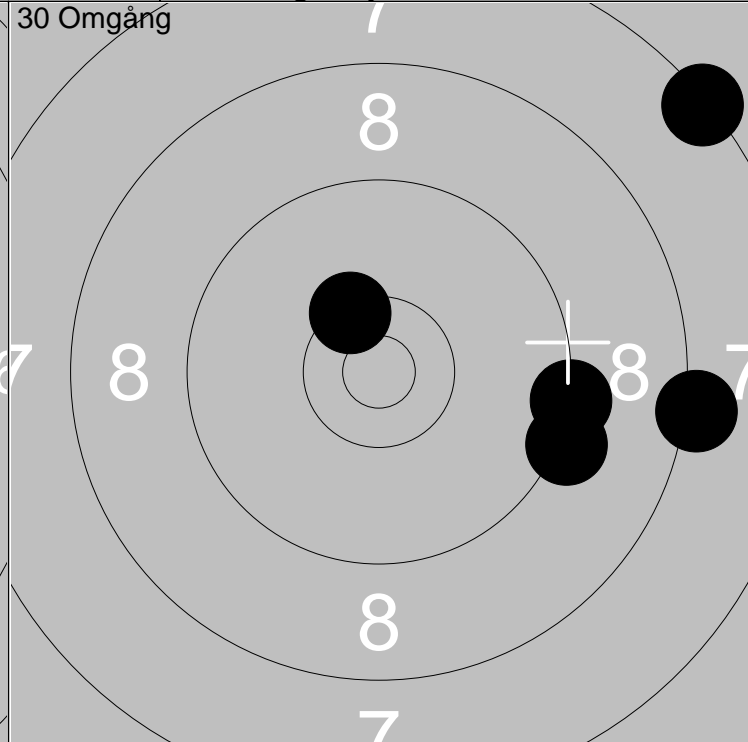
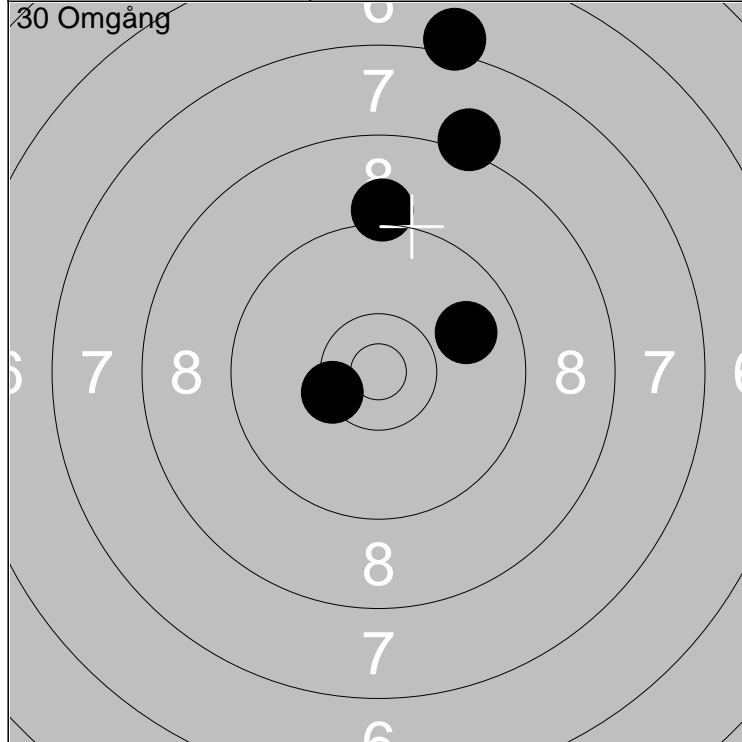

1: *10 ←	Serie	43
2: 8 ↑		
3: 9 ↑	Total	43
4: 7 ↑		
5: 9 →		

6: 8 →	Serie	43
7: *10 ↑		
8: 9 →	Total	86
9: 9 →		
10: 7 ↗		

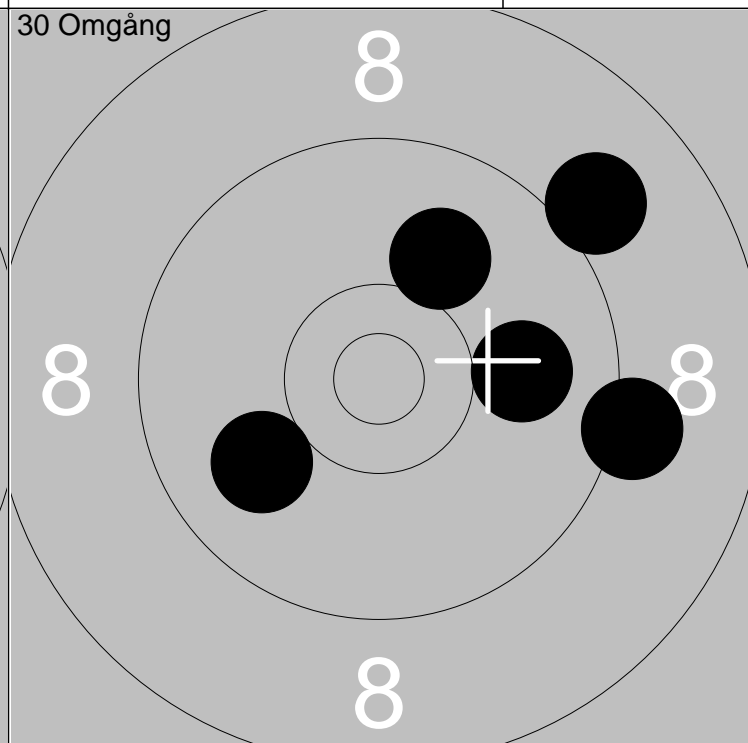
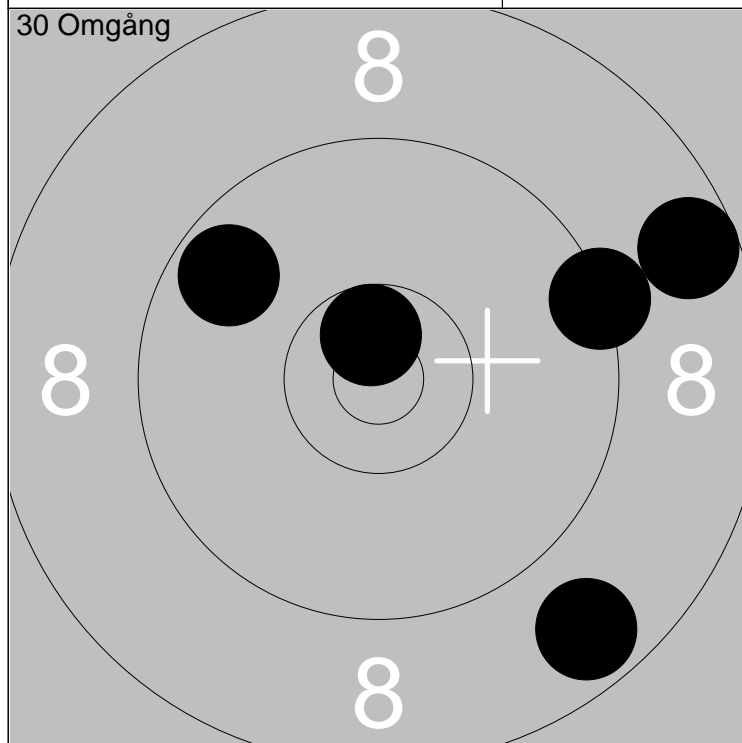

11: 8 ↘	Serie	44
12: 9 ↗		
13: 8 →	Total	130
14: 9 →		
15: *10 ↑		

16: 10 ←	Serie	48
17: 10 →		
18: 9 →	Total	178
19: 9 ↗		
20: 10 ↑		

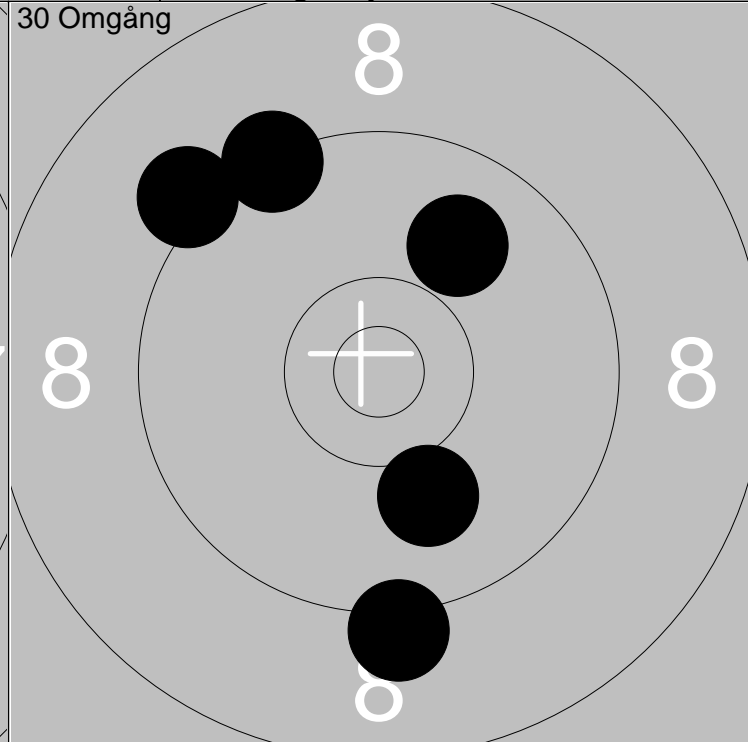
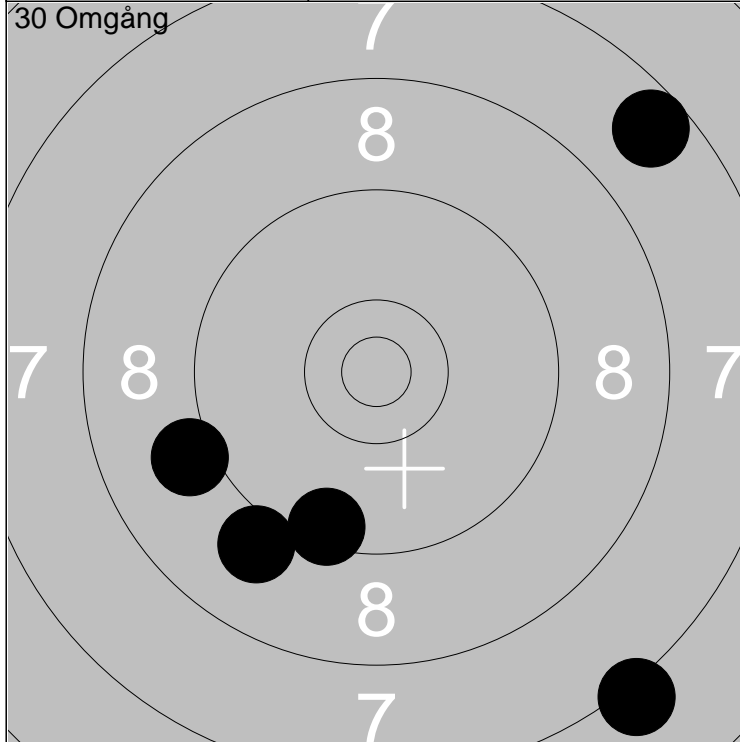

1: 7 ↘	Serie	41
2: 9 ↘		
3: 9 ↓	Total	41
4: 7 ↗		
5: 9 ←		

6: 9 ↗	Serie	46
7: 10 ↓		
8: 9 ↗	Total	87
9: 9 ↓		
10: 9 ↖		

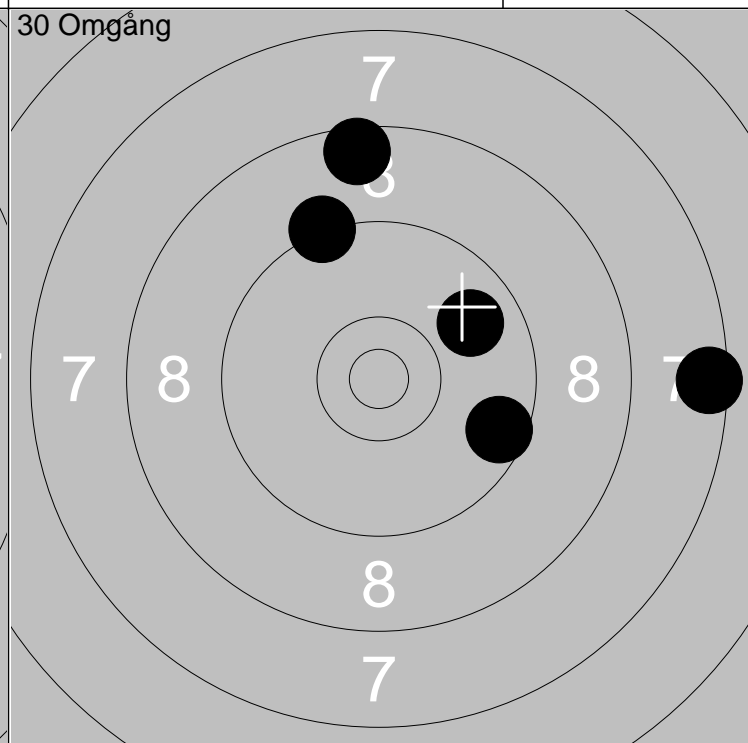
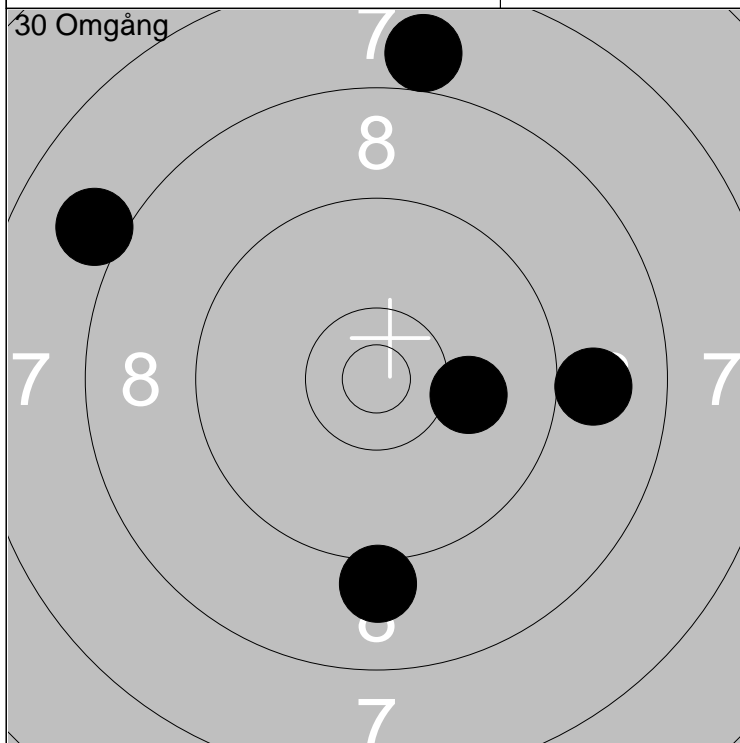

11: 8 ↖	Serie	44
12: 8 ↑		
13: 9 ↓	Total	131
14: 9 →		
15: 10 →		

16: 8 ↑	Serie	42
17: 9 ↗		
18: 9 →	Total	173
19: 9 ↑		
20: 7 →		

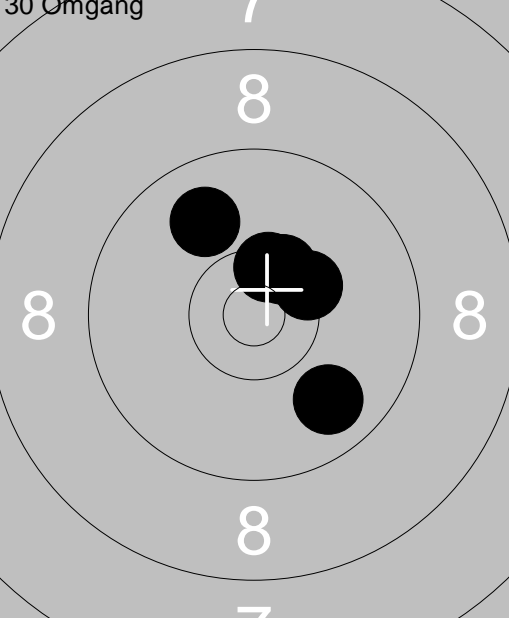
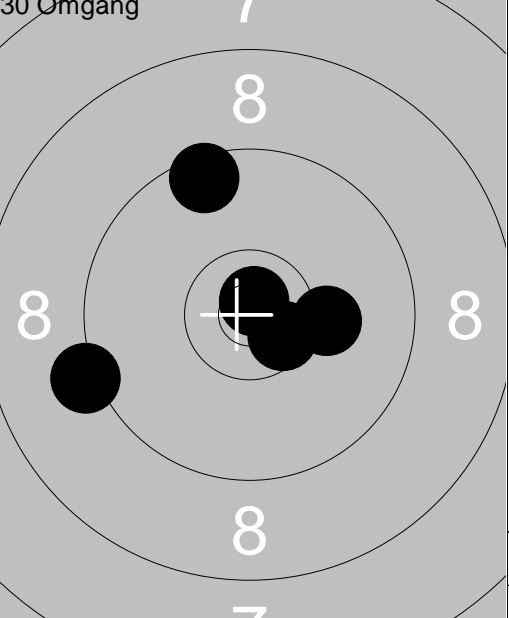
30 Omgång		30 Omgång
	1: 9 ↘ 2: *10 ↗ 3: *10 ↗ 4: 9 ↗ 5: *10 ↗	
	Serie 48	Serie 48
	Total 48	Total 96

30 Omgång		30 Omgång
	11: 9 ← 12: 9 → 13: 7 ↘ 14: 9 ← 15: 8 ↘	
	Serie 42	Serie 48
	Total 138	Total 186

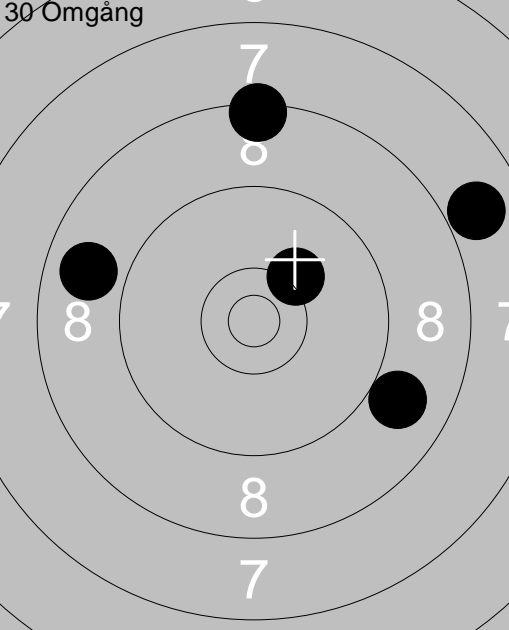
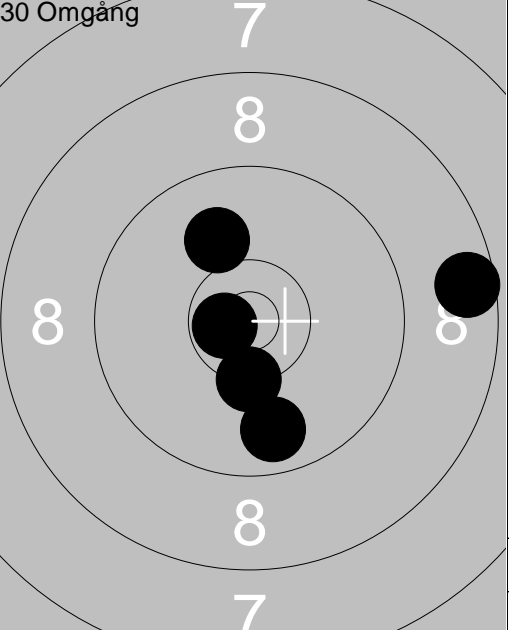
30 Omgång		30 Omgång
	21: 8 ← 22: 8 ↑ 23: 10 ↗ 24: 7 → 25: 8 →	
	Serie 41	Serie 47
	Total 227	Total 274

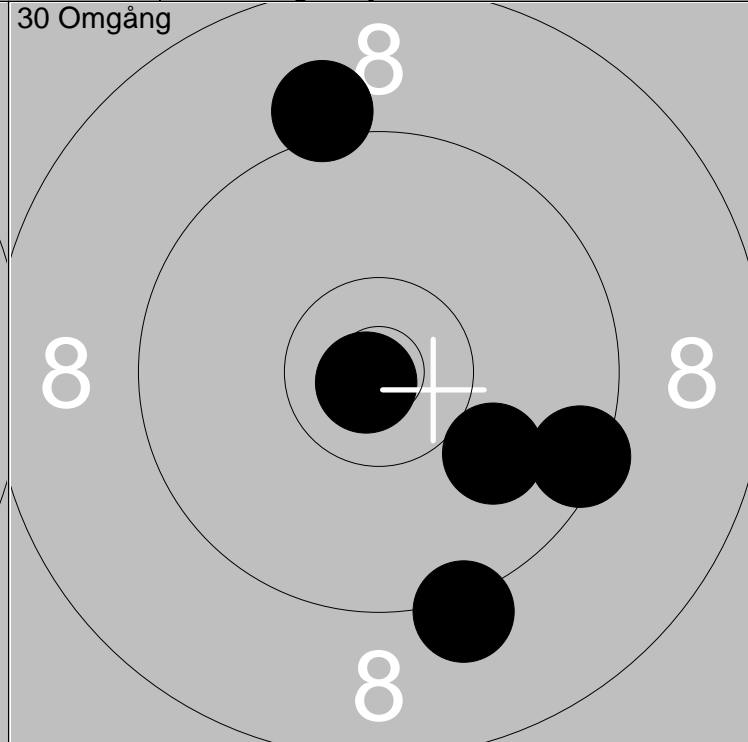
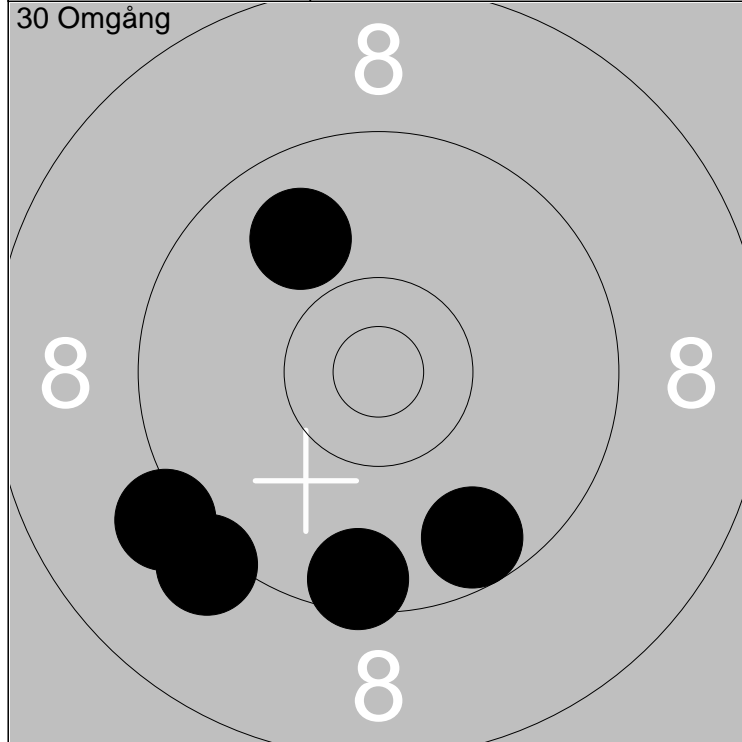

1: 9 ↙	Serie	45
2: 9 ↗		
3: 9 ↘	Total	45
4: 9 ↓		
5: 9 ↙		

6: 9 →	Serie	47
7: 9 ↓		
8: *10 ↙	Total	92
9: 10 ↘		
10: 9 ↑		

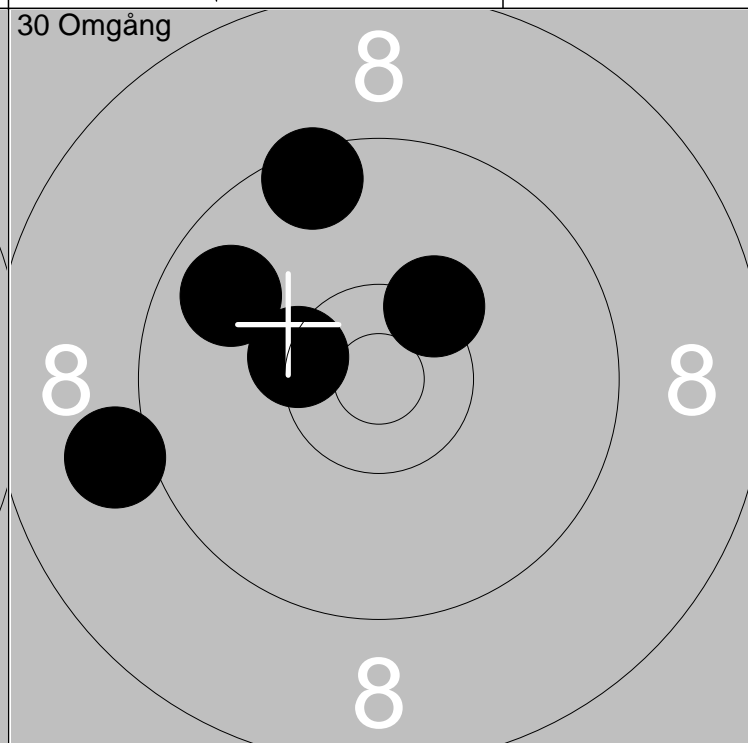
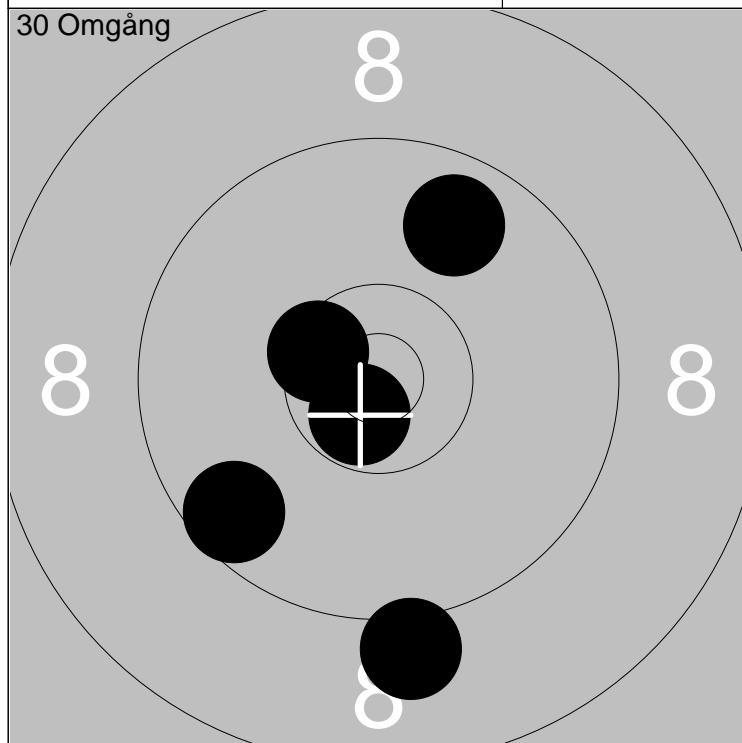

11: 9 ↗	Serie	47
12: *10 ↙		
13: 9 ↙	Total	139
14: 9 ↓		
15: *10 ↙		

16: *10 ↗	Serie	47
17: 9 ↗		
18: 9 ↙	Total	186
19: *10 ↙		
20: 9 ↙		

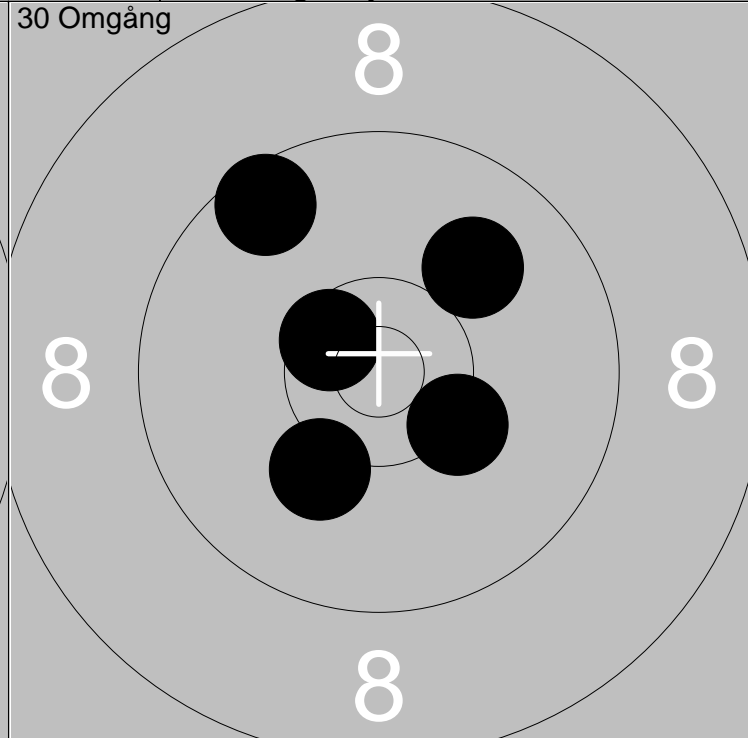
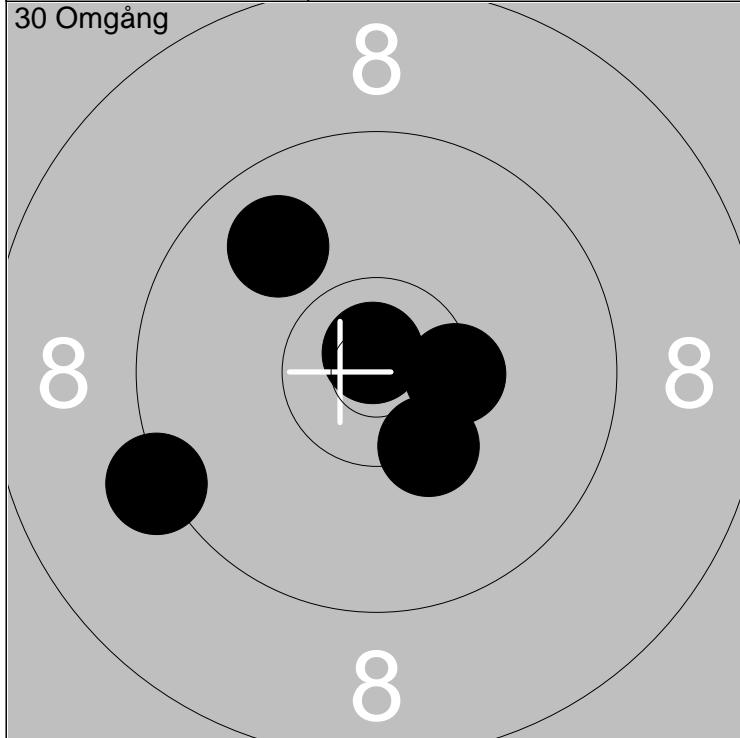

1: *10 ↑	Serie	48
2: 9 ←		
3: *10 →	Total	48
4: 9 ↗		
5: *10 ↘		

6: *10 ↗	Serie	49
7: 9 ↗		
8: *10 ↘	Total	97
9: 10 ↘		
10: 10 ↗		

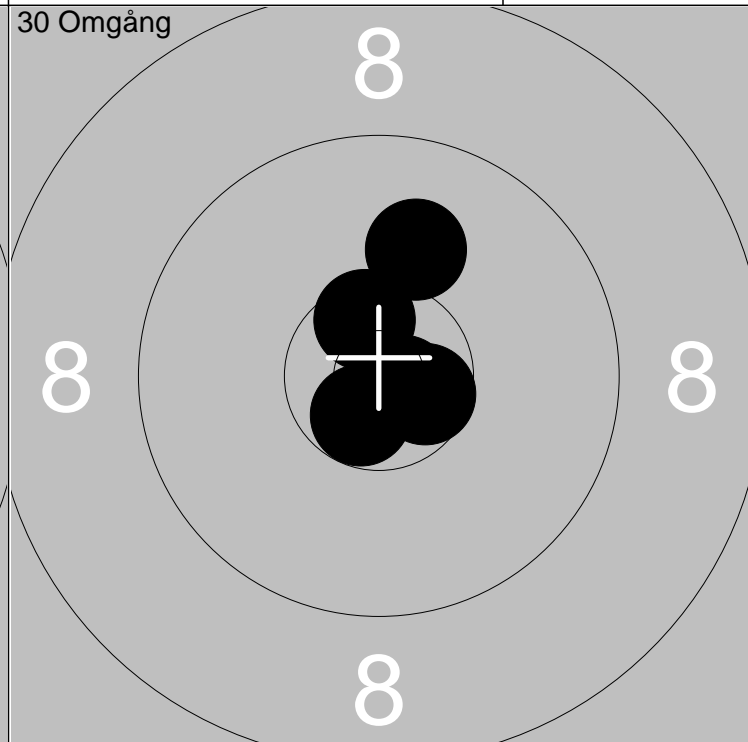
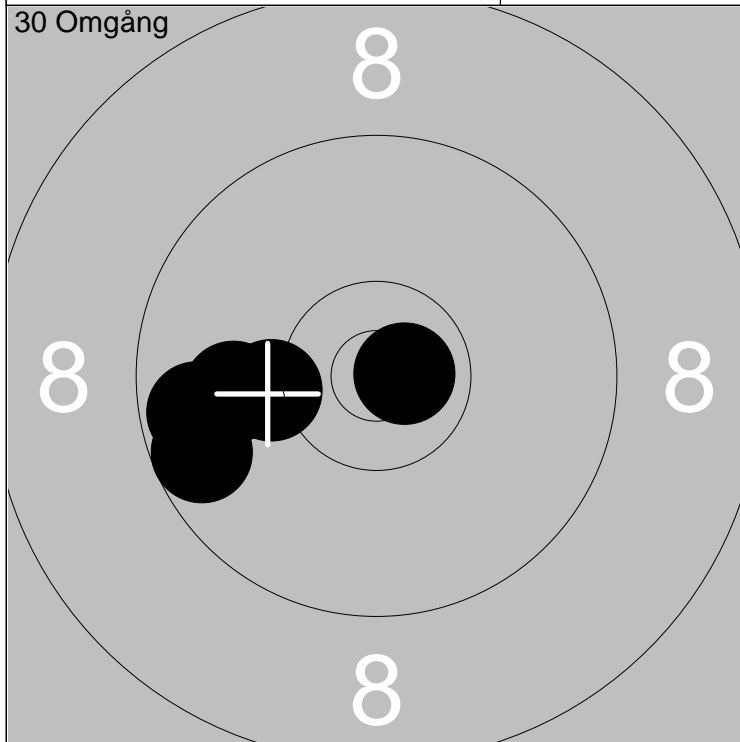

11: *10 →	Serie	48
12: 10 ←		
13: 10 ←	Total	145
14: 9 ←		
15: 9 ←		

16: *10 ↘	Serie	50
17: *10 →		
18: 10 ↗	Total	195
19: *10 ↗		
20: *10 →		

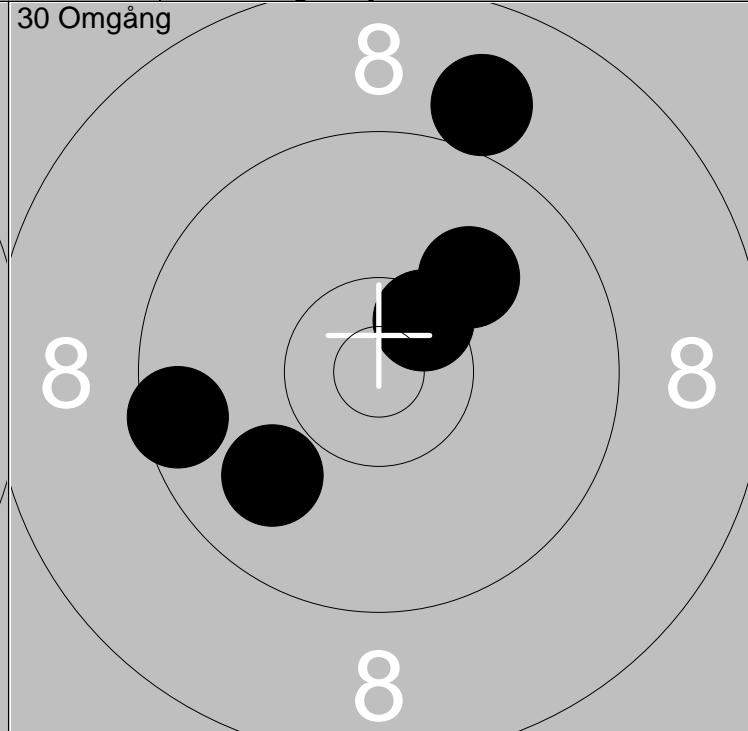
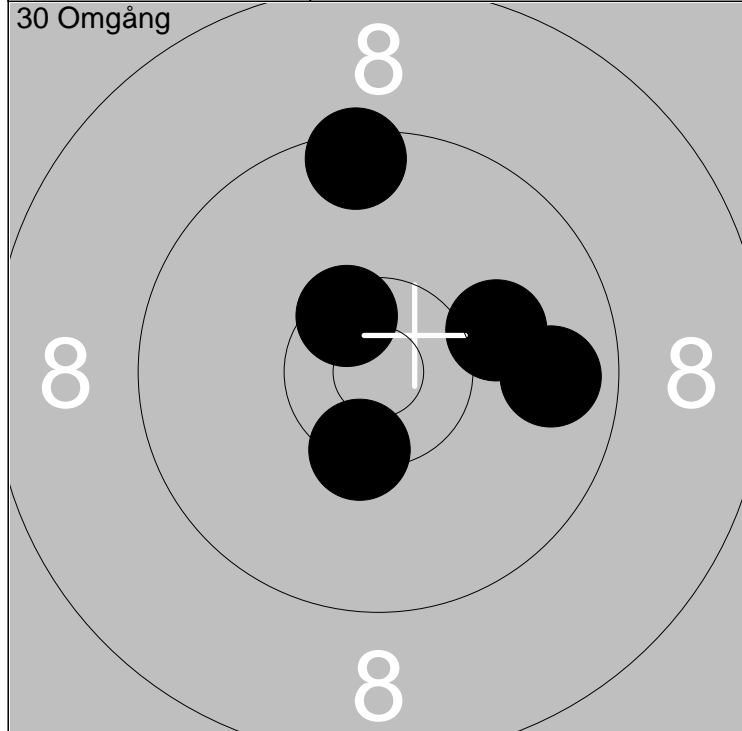

1: *10 ↖	Serie	48
2: 9 →		
3: 10 →	Total	48
4: 9 ↑		
5: *10 ↓		

6: 10 ↗	Serie	47
7: *10 ↗		
8: 9 ↑	Total	95
9: 9 ←		
10: 9 ↘		

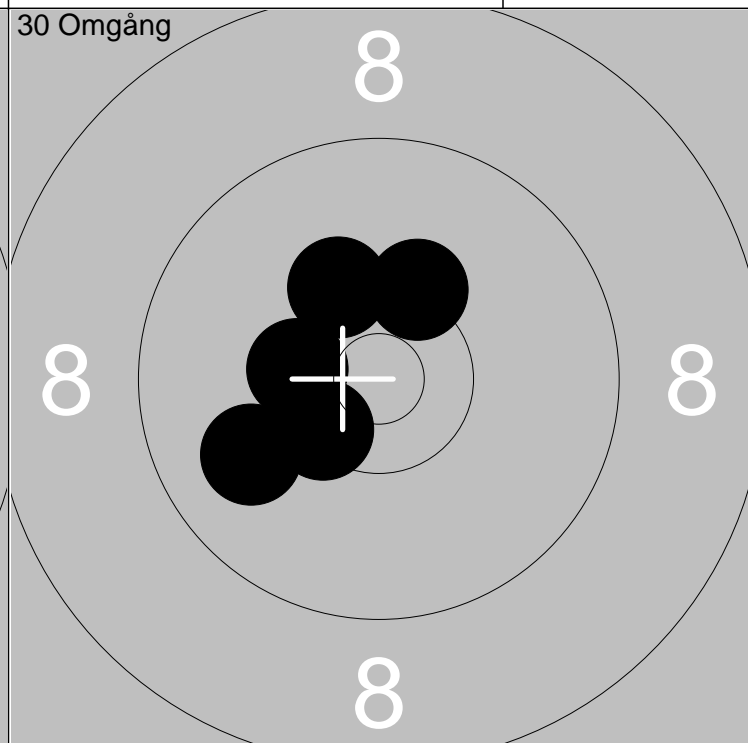
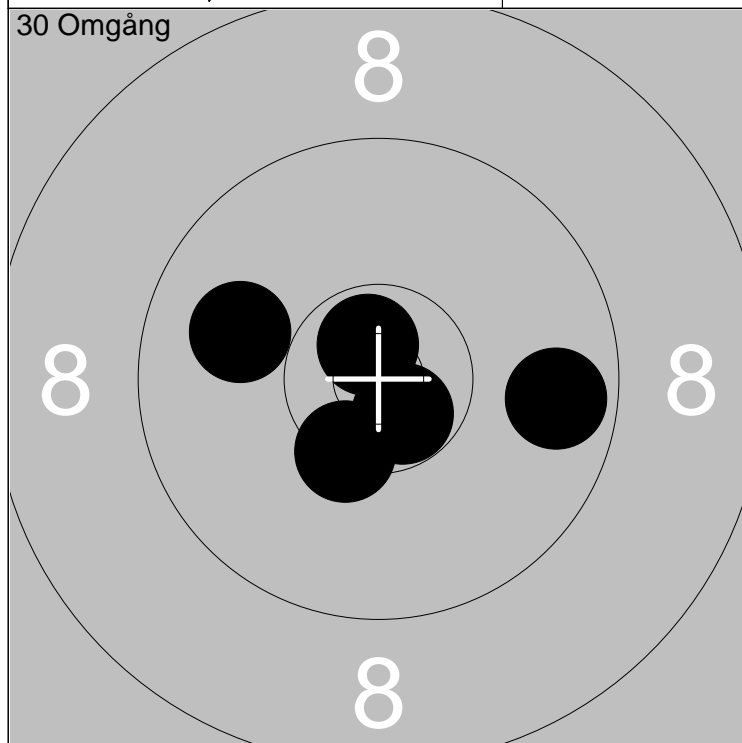

11: *10 ↑	Serie	48
12: 9 →		
13: *10 ↓	Total	143
14: *10 ↓		
15: 9 ←		

16: *10 ↘	Serie	49
17: *10 ←		
18: 9 ↙	Total	192
19: 10 ↑		
20: 10 ↑		

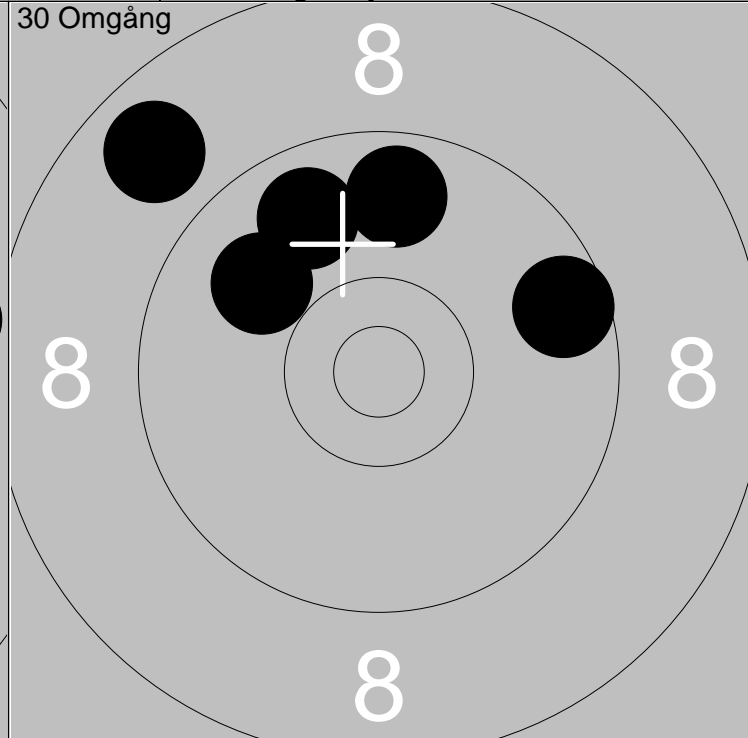
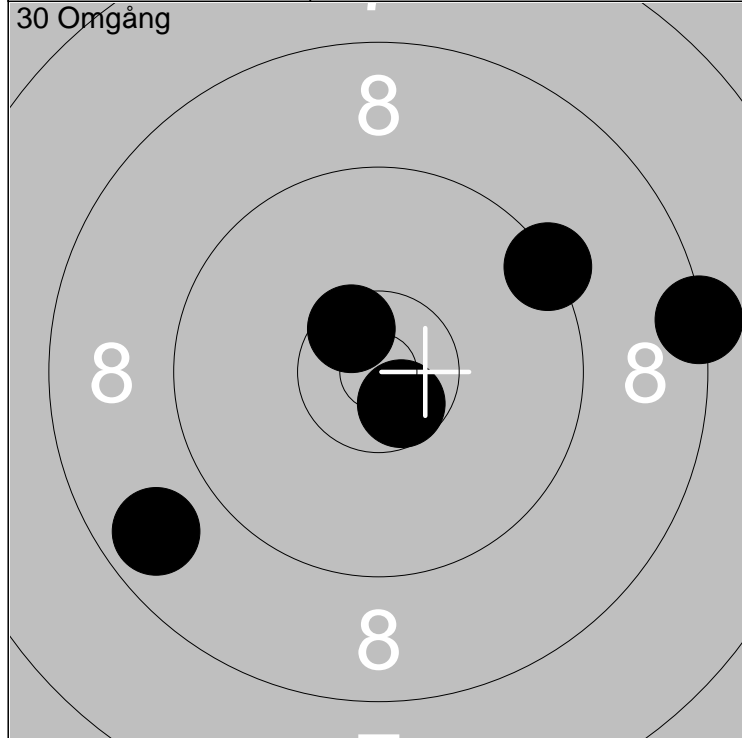

1: *10 ↘	Serie	45
2: *10 ↗		
3: 8 →	Total	45
4: 9 ↗		
5: 8 ↙		

6: 9 ↗	Serie	44
7: 9 →		
8: 8 ↗	Total	89
9: 9 ↑		
10: 9 ↗		

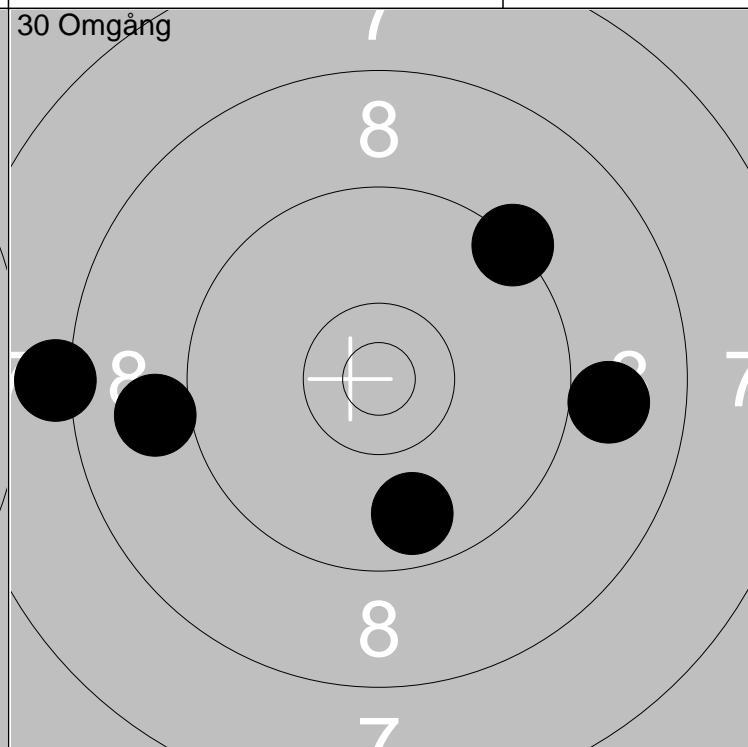
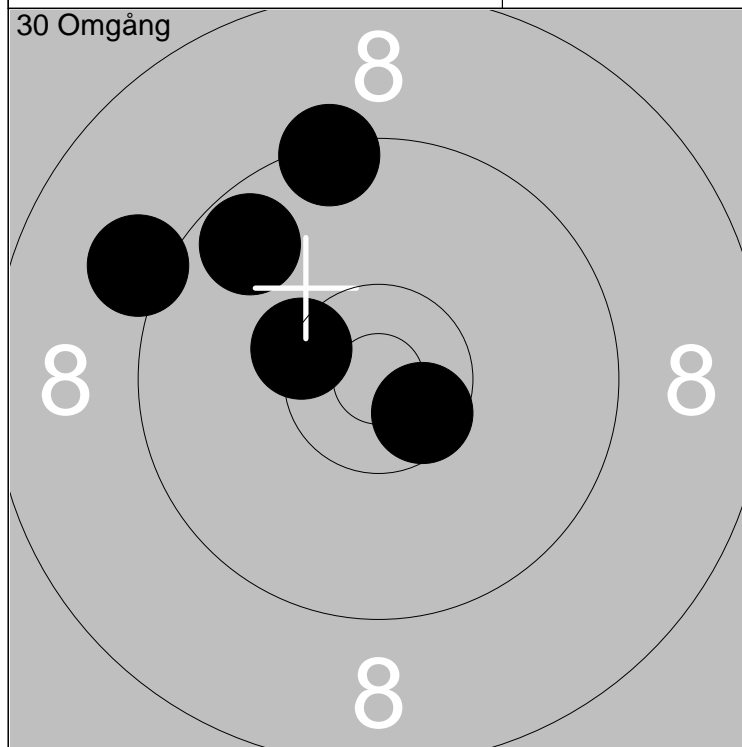

11: *10 ↖	Serie	47
12: 9 ↗		
13: 9 ↑	Total	136
14: *10 ↘		
15: 9 ↗		

16: 9 ↘	Serie	44
17: 8 ←		
18: 9 ↗	Total	180
19: 9 →		
20: 9 ←		

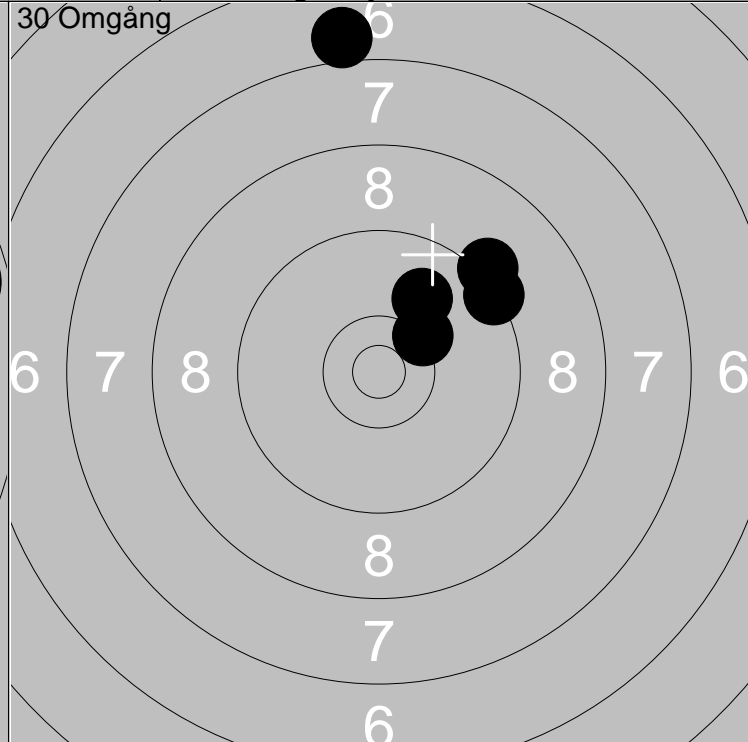
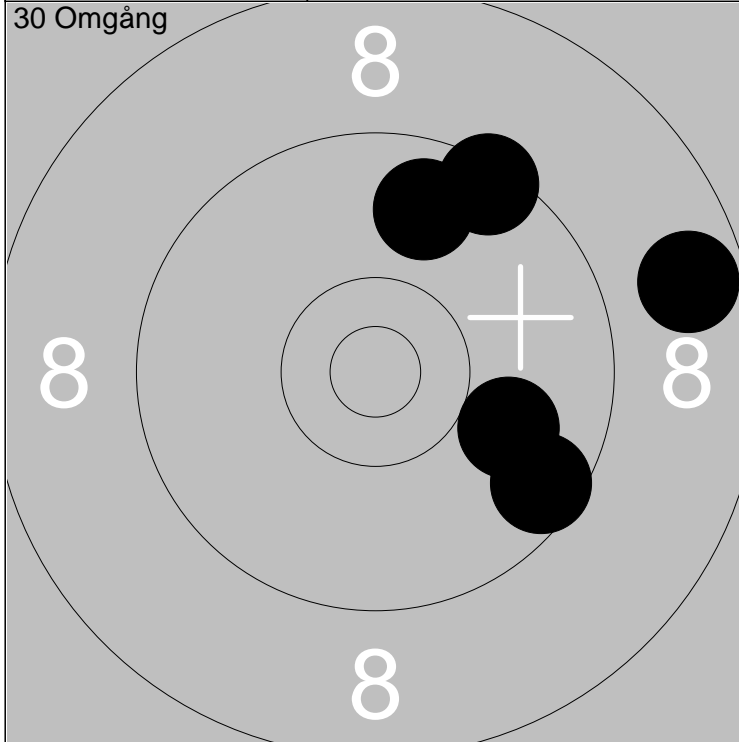

1: 10 →	Serie	45
2: 9 ↗		
3: 9 ↗	Total	45
4: 8 →		
5: 9 ↘		

6: 7 ↑	Serie	45
7: 9 ↗		
8: 10 ↗	Total	90
9: 9 ↗		
10: 10 ↗		

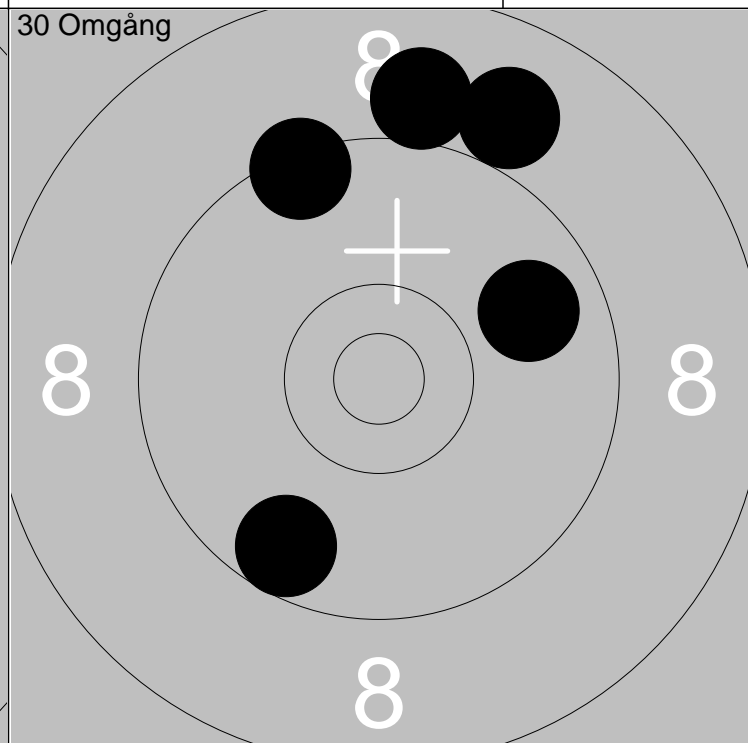
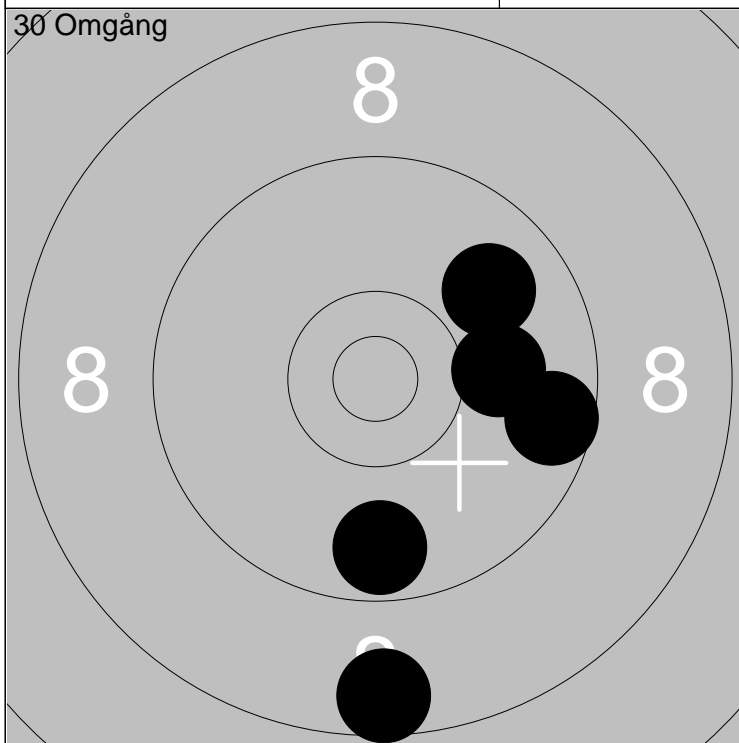

11: 8 ↓	Serie	45
12: 9 ↓		
13: 10 →	Total	135
14: 9 →		
15: 9 ↗		

16: 9 ↑	Serie	44
17: 9 ↗		
18: 9 ↘	Total	179
19: 9 ↑		
20: 8 ↗		

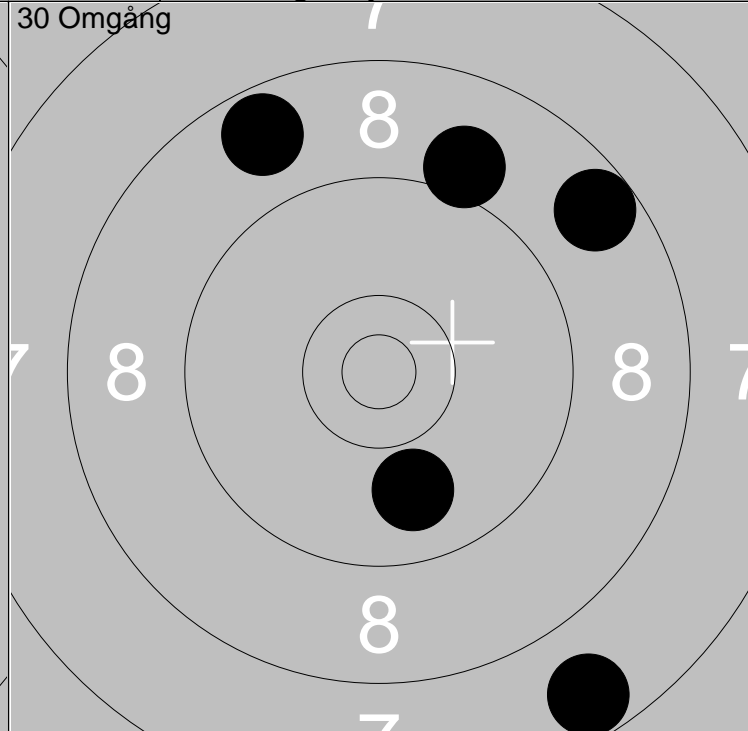
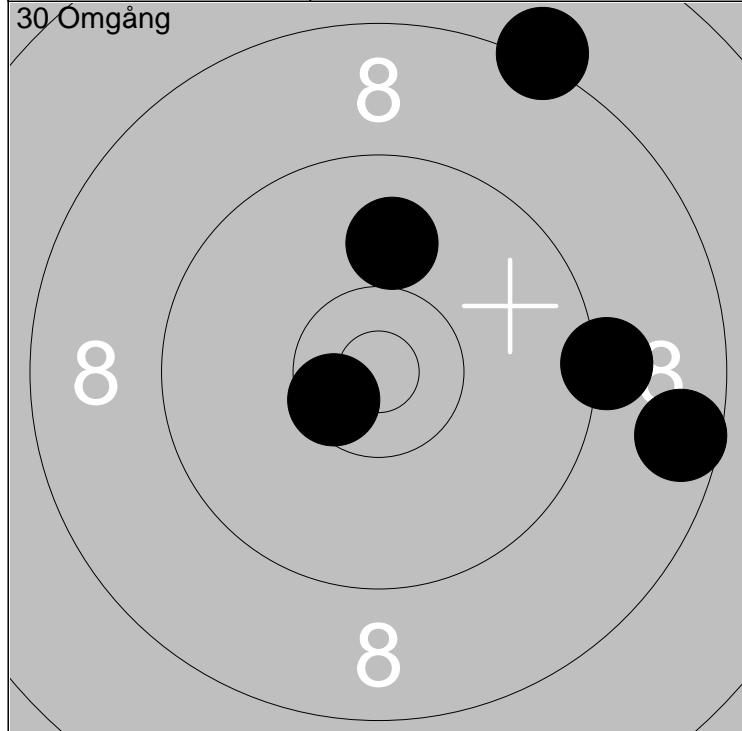

1: 9 →	Serie	45
2: 10 ↑		
3: 8 →	Total	45
4: 8 ↗		
5: *10 ↙		

6: 8 ↗	Serie	41
7: 9 ↗		
8: 9 ↘	Total	86
9: 7 ↘		
10: 8 ↗		

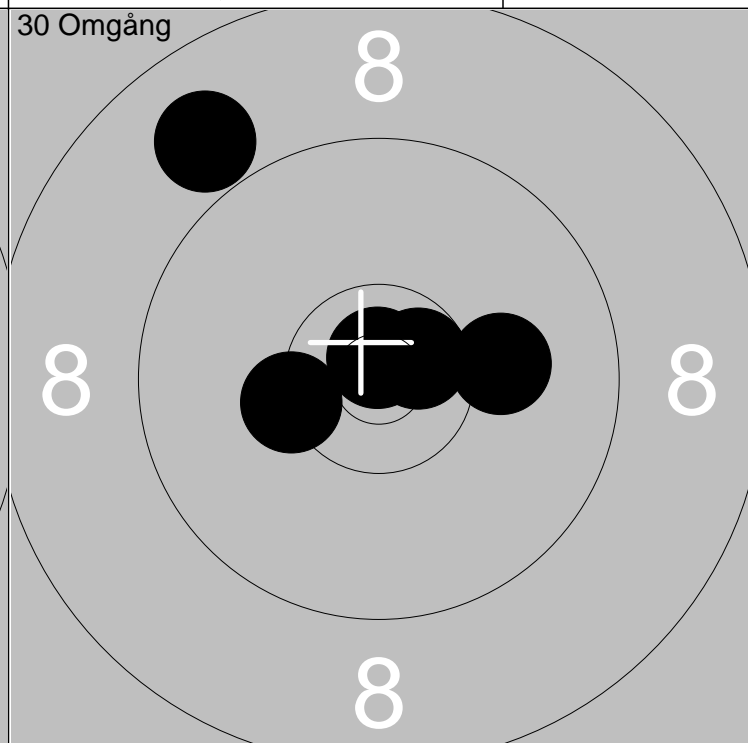
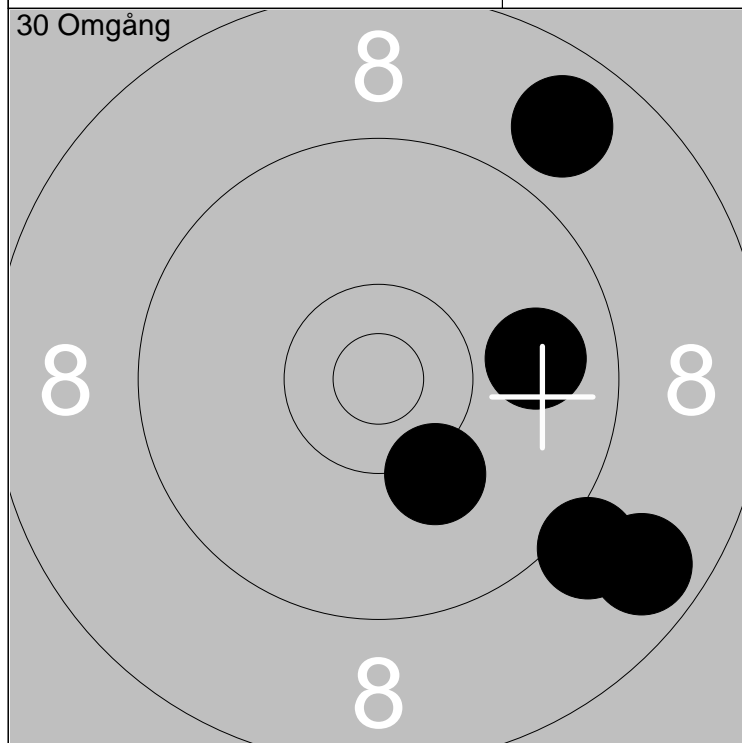

11: 8 ↘	Serie	44
12: 8 ↗		
13: 9 →	Total	130
14: 10 ↘		
15: 9 ↘		

16: 8 ↖	Serie	48
17: *10 ←		
18: *10 ↗	Total	178
19: *10 ↑		
20: 10 →		