

Skjutlag 1	Tavla 1	LEIF GUSTAVSSON	
----------------------	-------------------	------------------------	--

50m	Sörby/Odensberg Skf	K 65
-----	---------------------	------

27.06.2018	Mugg 3	Skaraborgs skytteförbund
------------	--------	--------------------------

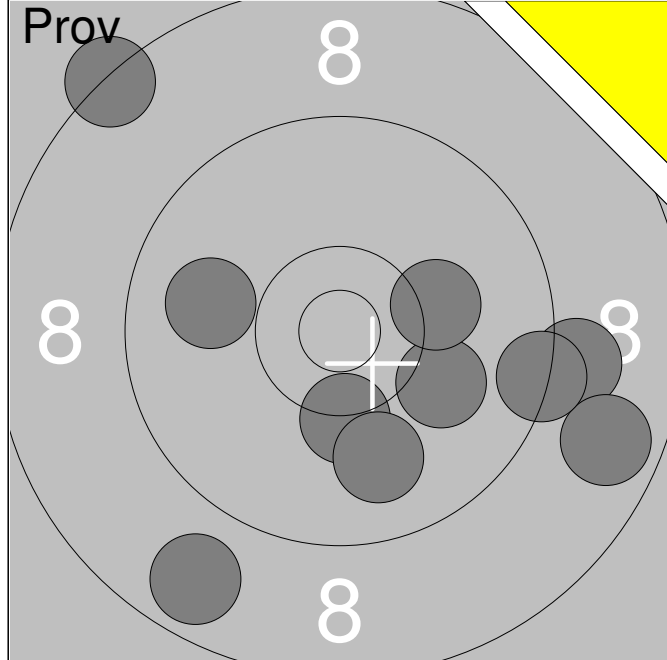

1:	8.3	↗
2:	10.3	↓
3:	10.1	↘
4:	9.1	→
5:	8.7	↘
6:	10.2	→
7:	9.4	→
8:	9.9	←
9:	8.7	↘
10:	9.9	↓

Serie	90.0
Total	0.0

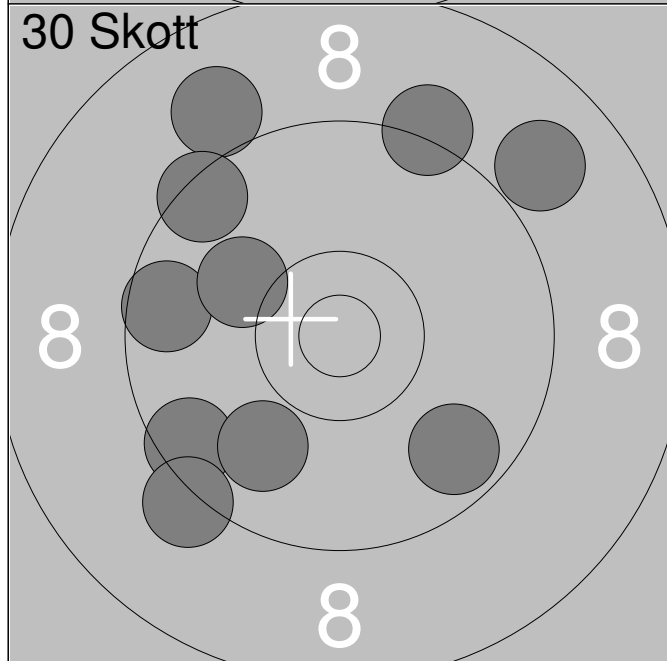

1:	9.6	←
2:	9.5	↙
3:	9.9	↙
4:	9.2	↑
5:	9.2	↙
6:	10.1	↗
7:	9.7	↘
8:	8.9	↗
9:	9.0	↗
10:	9.4	↗

Serie	90.0
Total	90.0

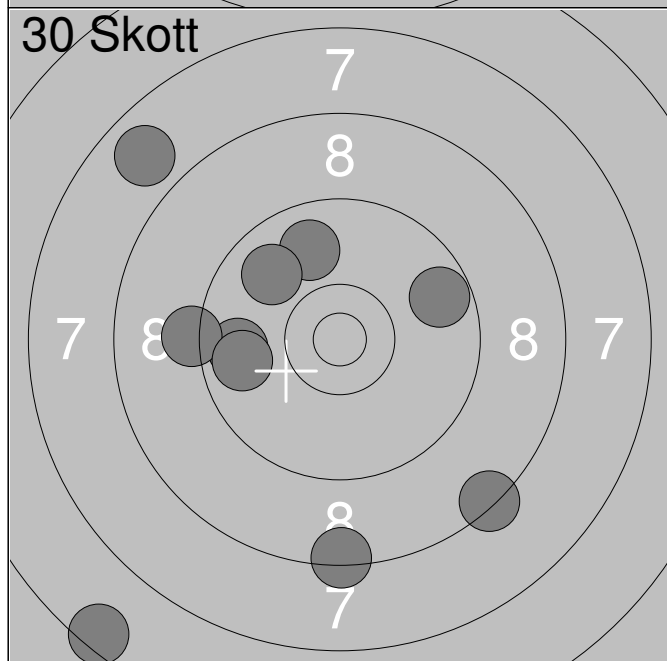

11:	6.5	↙
12:	8.4	↘
13:	8.4	↘
14:	9.9	↑
15:	9.7	←
16:	9.2	←
17:	9.7	→
18:	9.9	↗
19:	9.8	←
20:	7.8	↗

Serie	83.0
Total	173.0

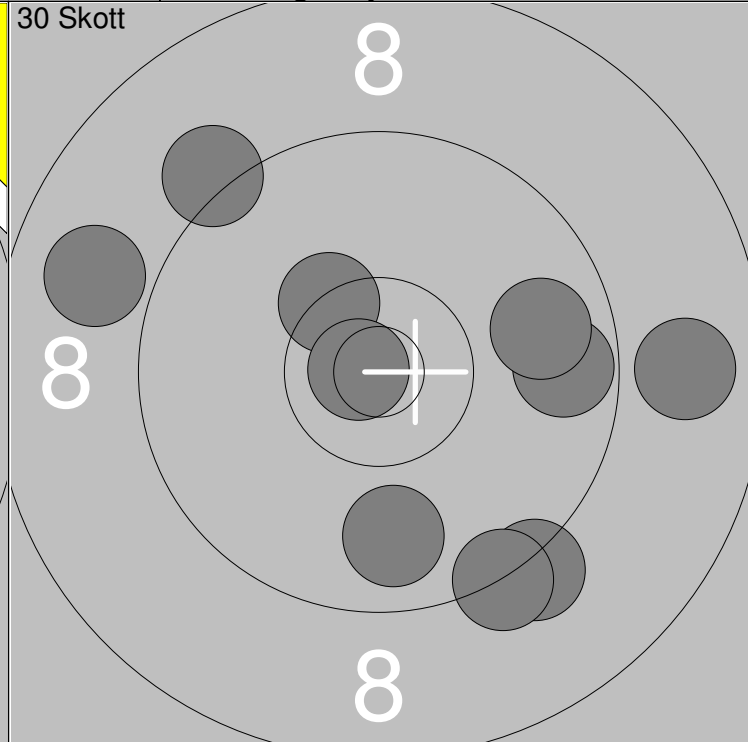
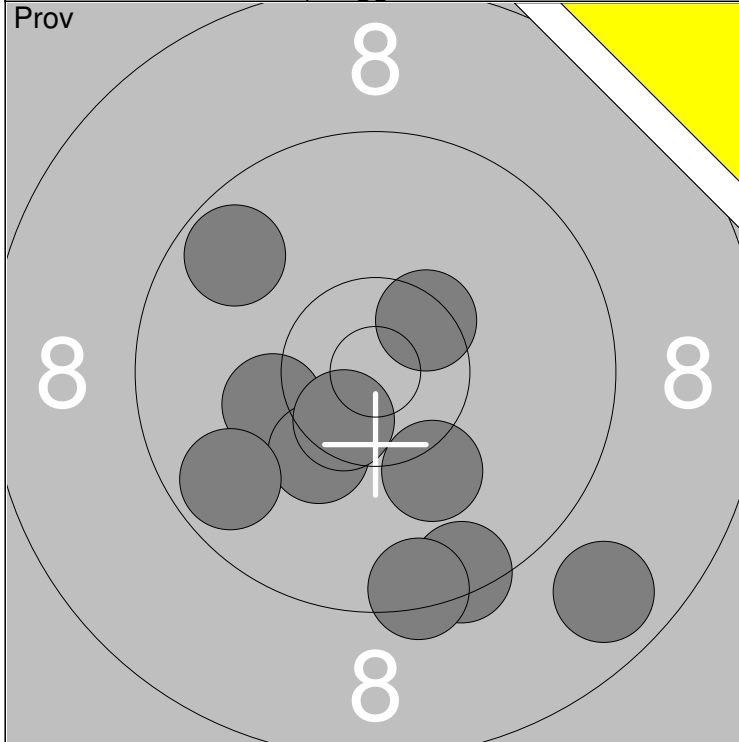

1: 10.2 ←	6: 10.6x ↘	Serie	94
2: 10.3 ↘	7: 10.5x ↗		
3: 9.5 ↘	8: 9.7 ←	Total	0
4: 9.7 ↗	9: 8.8 ↘		
5: 9.4 ↘	10: 10.2 ↘		

1: 9.2 ↘	6: 8.9 ←	Serie	90
2: 9.8 ↘	7: 8.8 →		
3: 9.3 ↘	8: 10.8x ←	Total	90
4: 9.7 →	9: 9.2 ↗		
5: 10.4x ↗	10: 9.8 →		

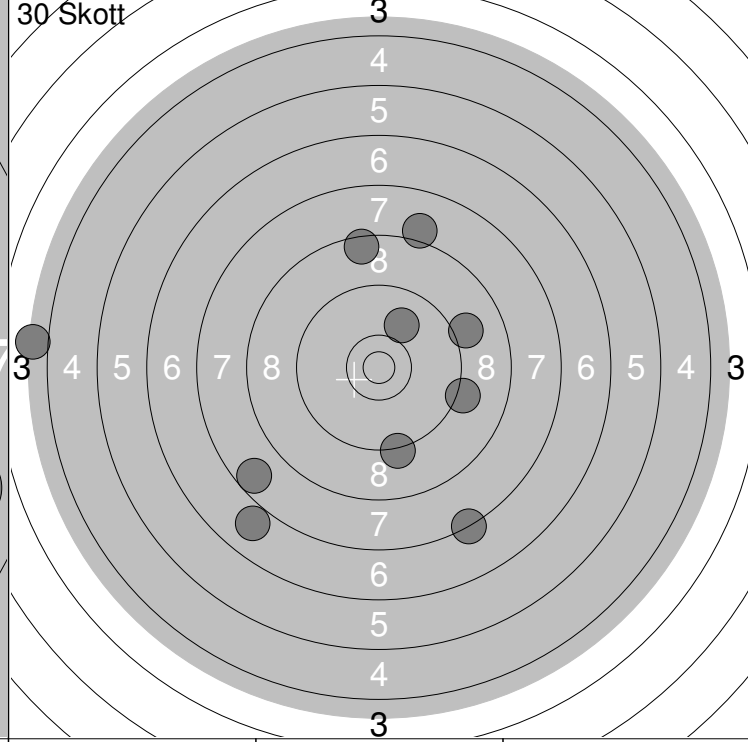
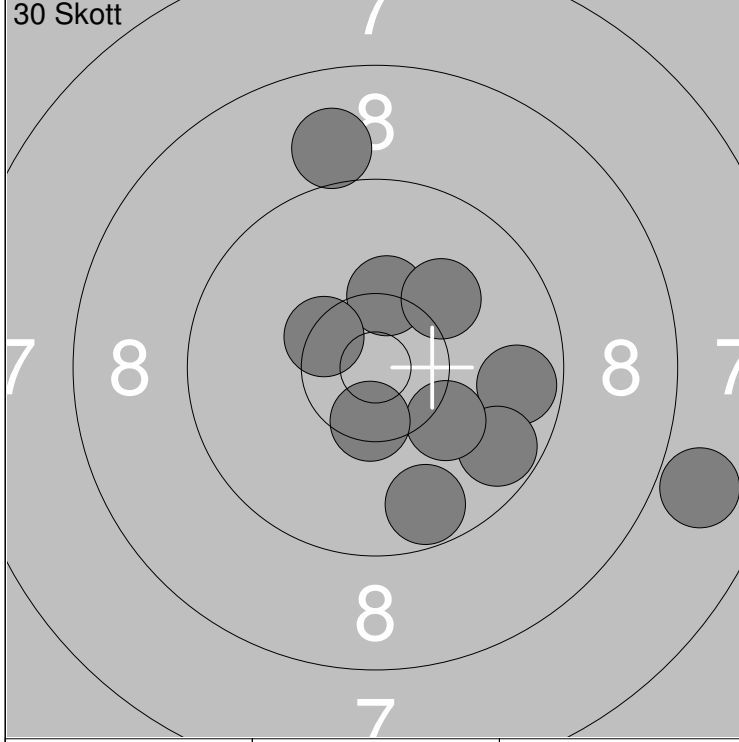

11: 7.9 →	16: 9.7 ↘	Serie	93
12: 9.7 →	17: 10.2 ↘		
13: 10.3x ↑	18: 10.5x ↘	Total	183
14: 10.1 ↗	19: 9.7 ↘		
15: 9.0 ↑	20: 10.4x ↗		

21: 8.5 ↑	26: 7.3 ↘	Serie	77
22: 8.1 ↑	27: 10.0 ↗		
23: 6.9 ↘	28: 9.0 ↗	Total	260
24: 7.6 ↘	29: 9.2 ↘		
25: 4.0 ←	30: 9.2 →		

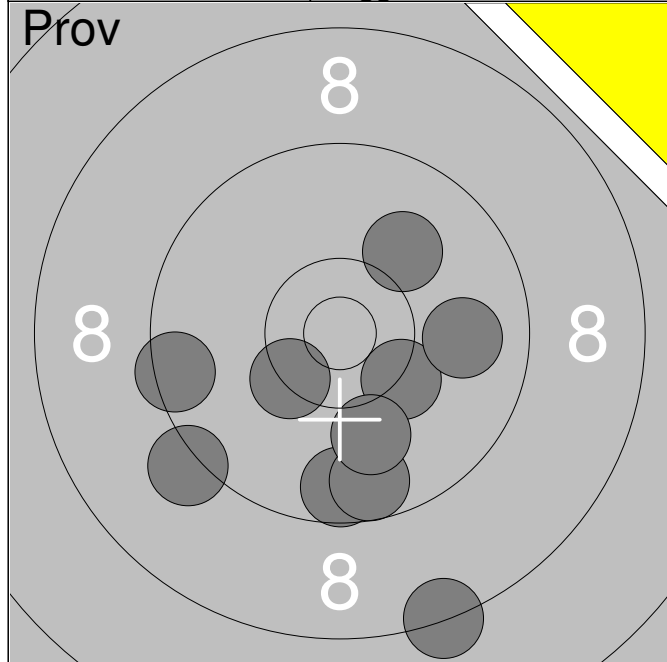

1:	10.1	↗
2:	8.3	↓
3:	9.2	↙
4:	9.6	↓
5:	9.5	←
6:	9.6	↓
7:	10.4x	↙
8:	10.3x	↓
9:	10.0	↓
10:	9.9	→

Serie	93.0
Total	0.0

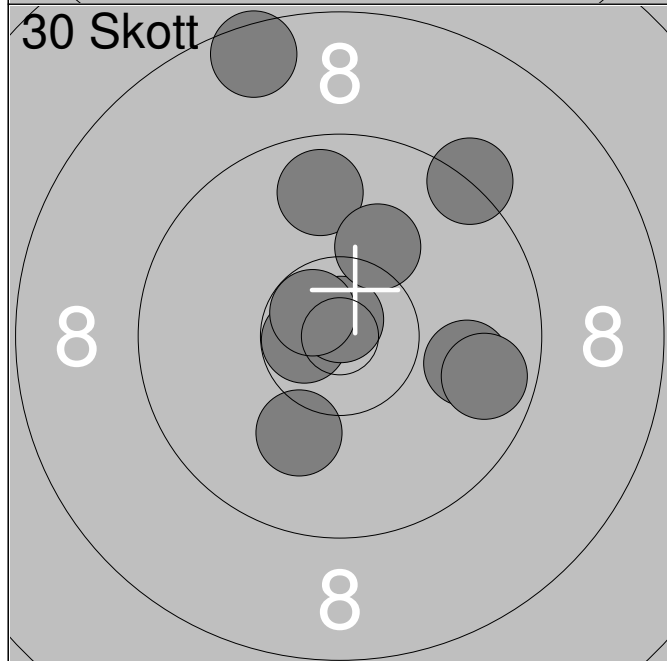

1:	10.7x	←
2:	10.8x	↑
3:	10.1	↓
4:	9.9	→
5:	9.8	↑
6:	10.7x	↗
7:	10.2	↑
8:	8.5	↑
9:	9.7	→
10:	9.3	↗

Serie	94.0
Total	94.0

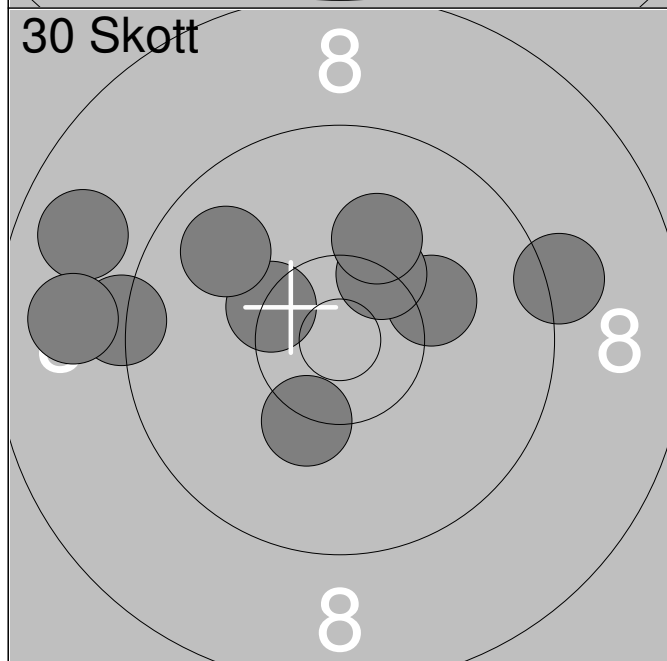

11:	9.3	←
12:	10.4x	↗
13:	10.2	→
14:	10.4x	↗
15:	8.8	↙
16:	10.3	↓
17:	9.8	↗
18:	10.1	↑
19:	9.2	→
20:	8.9	←

Serie	93.0
Total	187.0

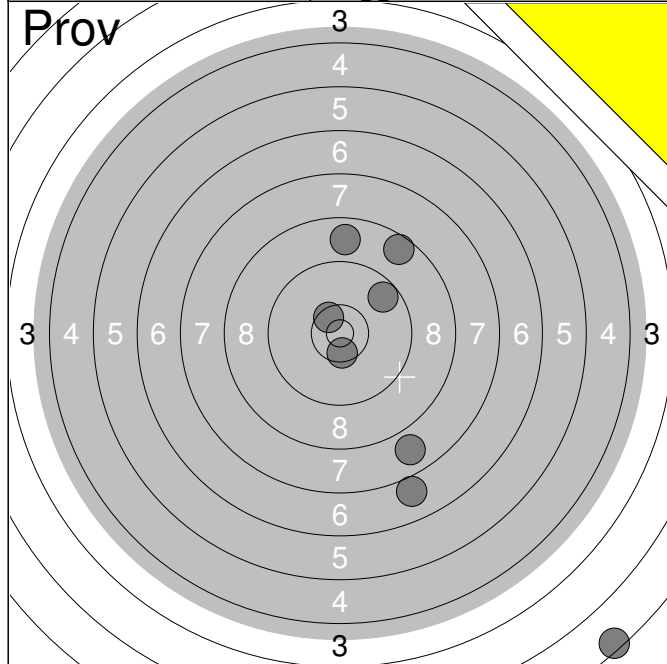

1:	8.8	↑
2:	8.6	↗
3:	9.7	↗
4:	1.5	↘
5:	10.5x	↘
6:	7.0	↘
7:	7.8	↘
8:	10.5x	↗
Serie		60.0
Total		0.0

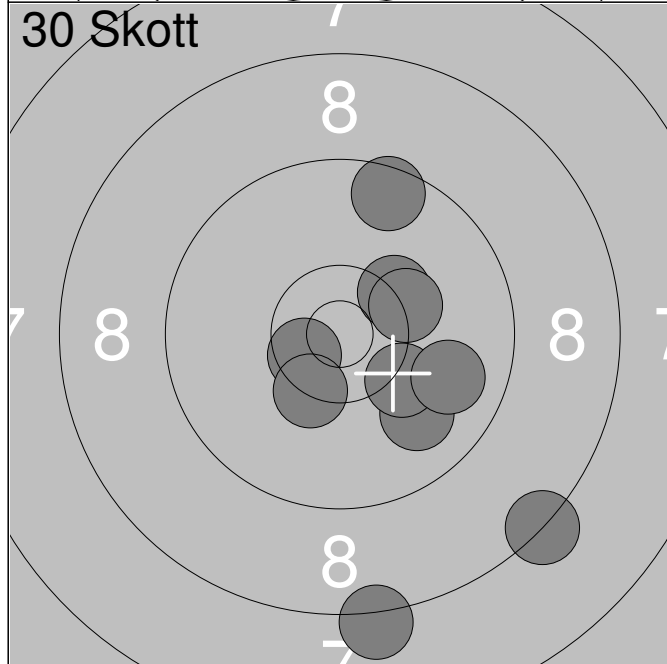

1:	9.9	↘
2:	8.2	↘
3:	10.2	↘
4:	10.6x	↙
5:	10.3x	↗
6:	8.3	↘
7:	9.9	→
8:	9.5	↑
9:	10.3x	↘
10:	10.3	→
Serie		93.0
Total		93.0

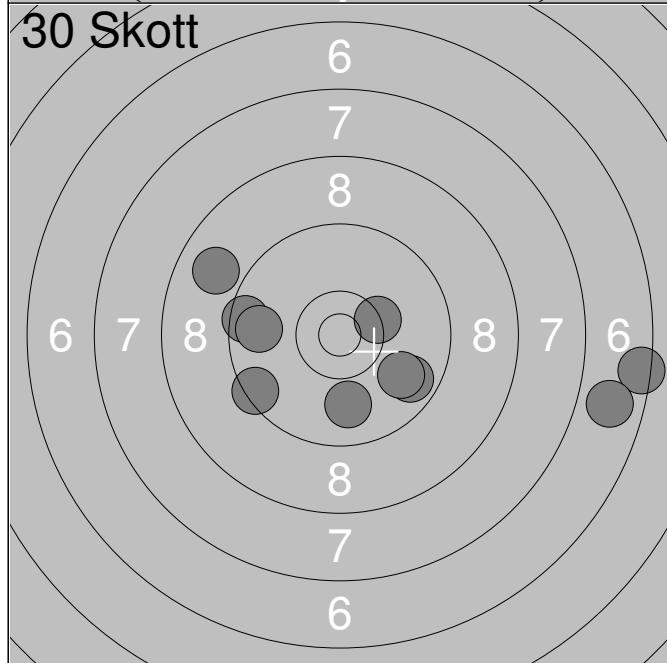

11:	9.9	↘
12:	9.5	↙
13:	9.7	↙
14:	8.9	↗
15:	9.7	↘
16:	9.9	↘
17:	10.3x	→
18:	6.4	→
19:	6.8	→
20:	9.4	↙
Serie		84.0
Total		177.0

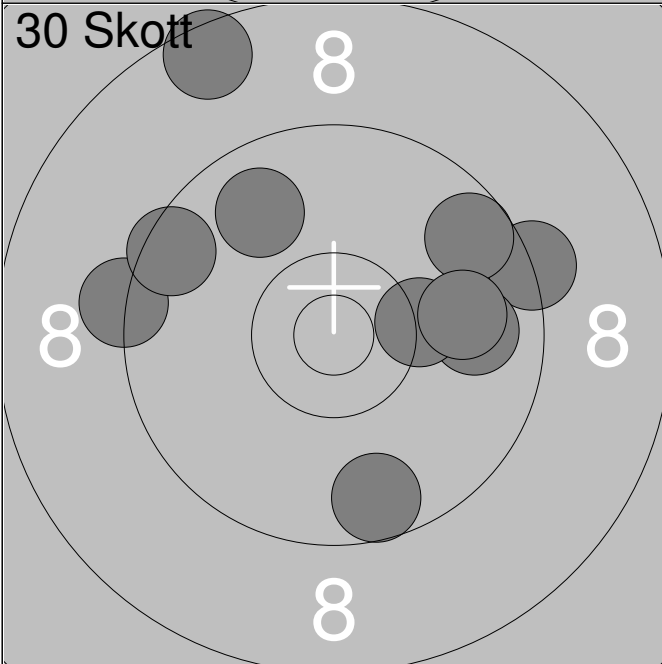
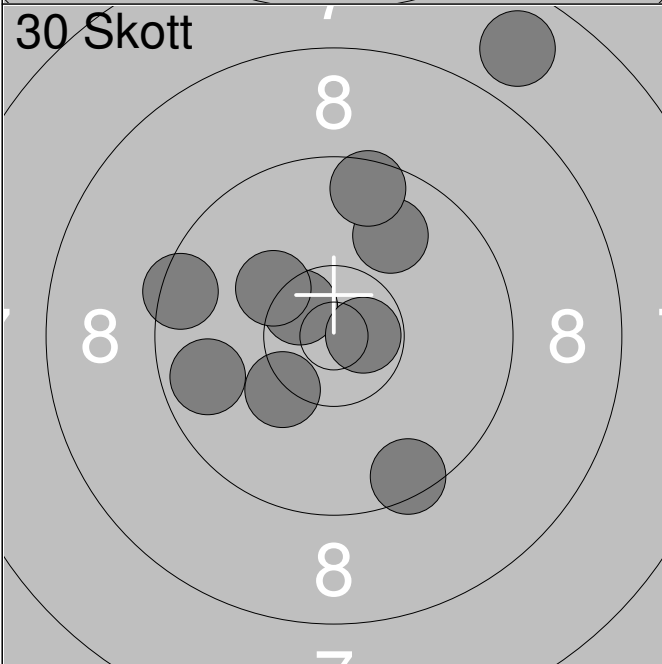
Skjutlag	Tavla	KERSTIN ENGSTRÖM	
1	5	Falköping Skg	Support
27.06.2018	Mugg 3	Skaraborgs skytteförbund	
Prov 	1:	9.0	↙
	2:	9.5	↙
	3:	10.2	←
	4:	9.5	↙
	5:	8.4	↗
	6:	9.8	↗
	7:	10.0	↑
	8:	10.6x	↘
	9:	10.1	↘
	10:	9.9	↑
	Serie		93.0
Total		0.0	
30 Skott 	1:	9.3	→
	2:	9.6	↗
	3:	9.8	↗
	4:	9.8	→
	5:	8.5	↗
	6:	9.3	←
	7:	10.3	→
	8:	9.5	↗
	9:	9.6	↘
	10:	9.9	→
	Serie		90.0
Total		90.0	
30 Skott 	11:	9.5	←
	12:	9.5	↘
	13:	10.5x	↗
	14:	9.7	←
	15:	10.2	↗
	16:	9.9	↗
	17:	7.8	↗
	18:	10.7x	→
	19:	9.6	↑
	20:	10.3	↙
	Serie		92.0
Total		182.0	

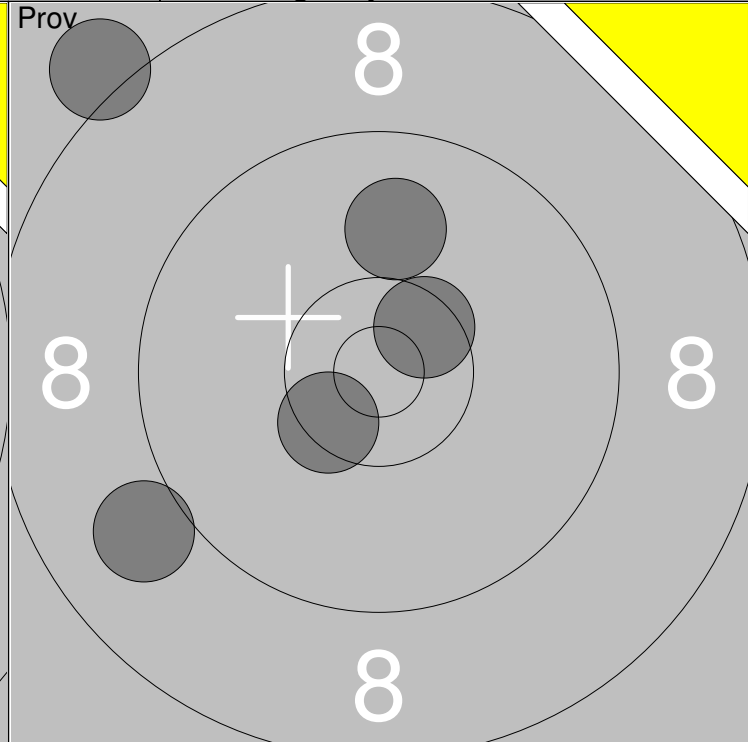
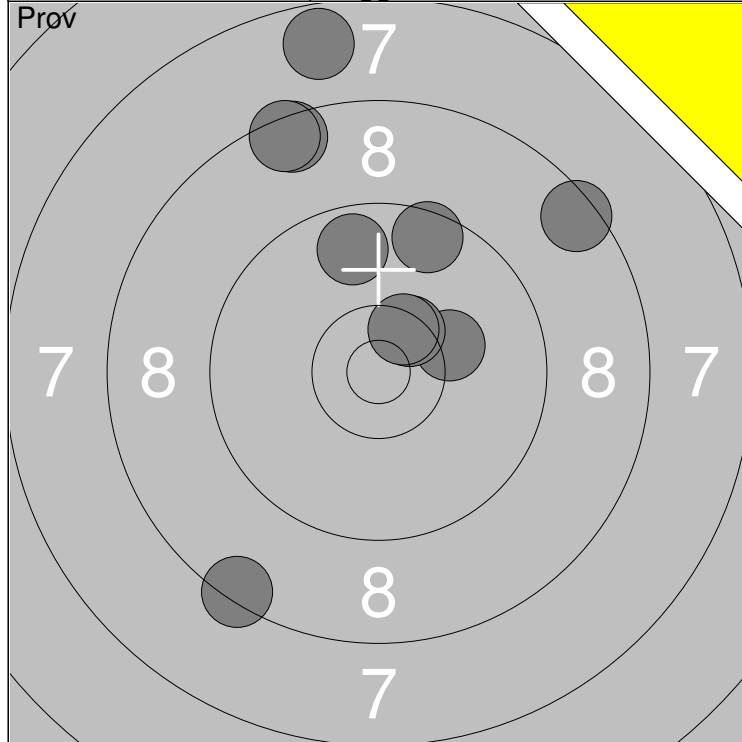

1: 7.7 ↑	6: 10.4x ↗	Serie	87
2: 8.5 ↑	7: 8.5 ↑		
3: 8.5 ↗	8: 10.5x ↗	Total	0
4: 9.6 ↑	9: 9.7 ↑		
5: 10.2 →	10: 8.4 ↘		

11: 10.0 ↑	Serie	47
12: 8.1 ↖		
13: 9.0 ↙	Total	0
14: 10.5x ↙		
15: 10.5x ↗		

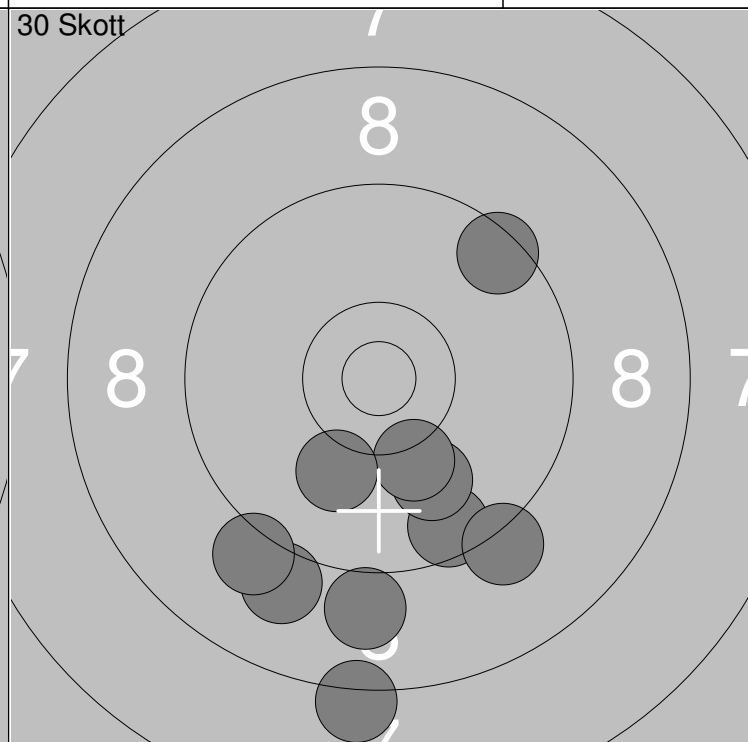
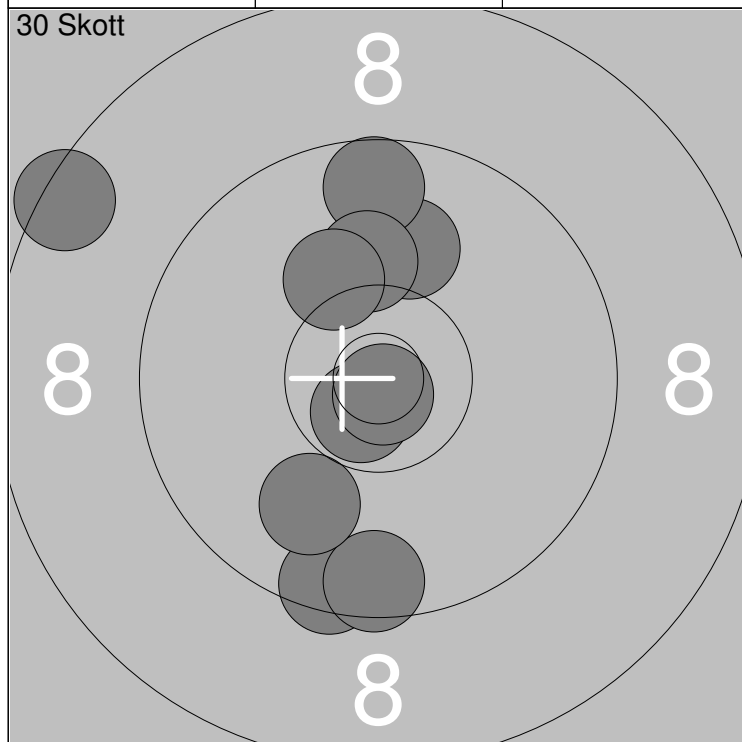

1: 10.0 ↑	6: 8.5 ↖	Serie	95
2: 9.6 ↑	7: 9.5 ↓		
3: 10.1 ↑	8: 10.8x ↓	Total	95
4: 10.2 ↑	9: 9.6 ↓		
5: 10.7x ↓	10: 10.0 ↓		

11: 9.5 ↗	16: 10.1 ↓	Serie	92
12: 9.6 ↓	17: 8.2 ↓		
13: 10.0 ↓	18: 9.0 ↓	Total	187
14: 9.2 ↓	19: 9.0 ↓		
15: 10.2 ↓	20: 9.1 ↓		

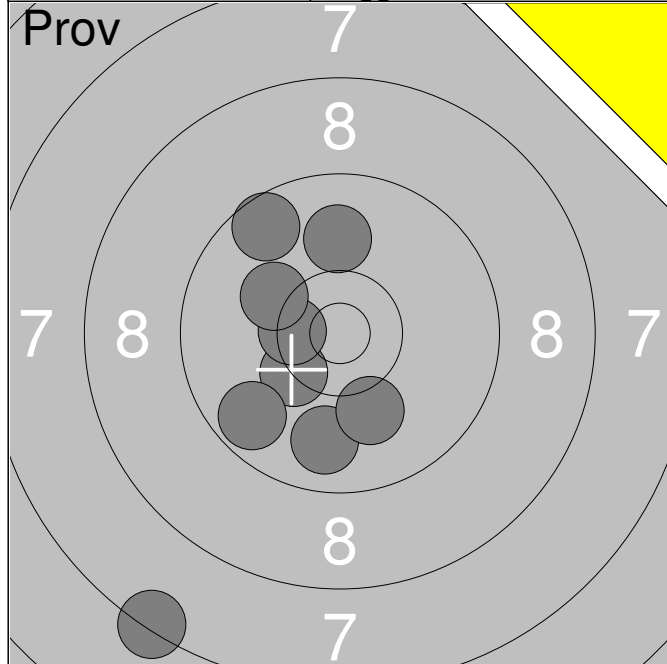

1:	7.4	↙
2:	9.8	↘
3:	9.6	↗
4:	10.3x	↙
5:	10.5x	←
6:	9.7	↙
7:	10.1	↘
8:	10.2	↗
9:	10.0	↑

Serie	84.0
Total	0.0

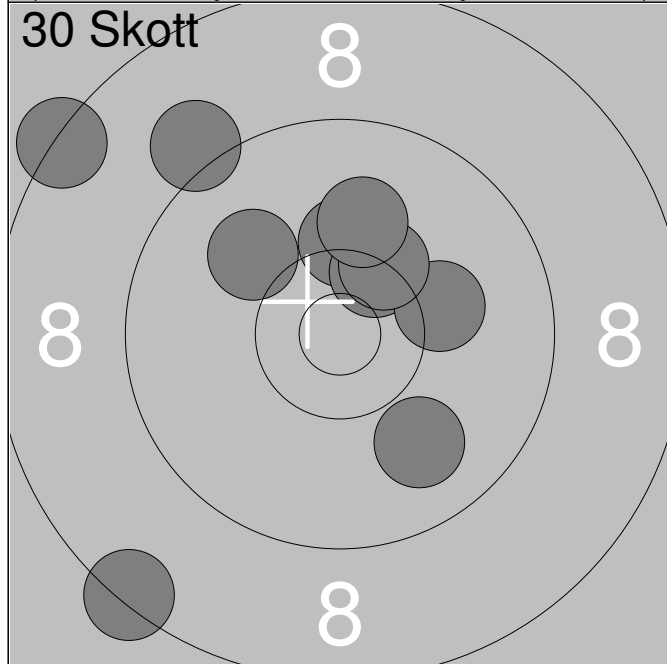

1:	10.2	↑
2:	9.1	↗
3:	8.4	↙
4:	9.9	↘
5:	8.4	↗
6:	10.4x	↗
7:	10.2	→
8:	10.3x	↗
9:	10.1	↑
10:	10.0	↗

Serie	94.0
Total	94.0

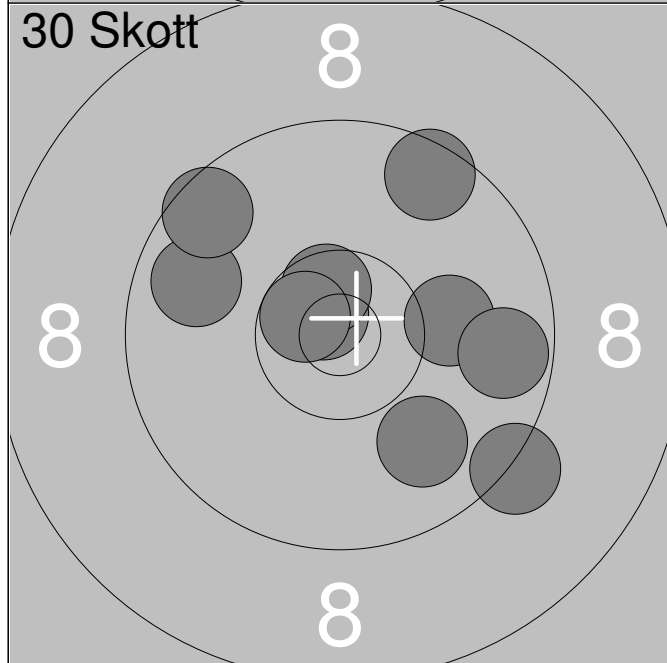

11:	10.7x	↗
12:	9.3	↘
13:	10.1	→
14:	9.9	↘
15:	10.6x	↗
16:	9.8	↗
17:	9.5	↗
18:	10.6x	↗
19:	9.7	→
20:	9.6	↗

Serie	94.0
Total	188.0

Skjutlag	Tavla	KENNY ALM	
1	8		

50m	Axvalls Skf	K 65
-----	-------------	------

27.06.2018	Mugg 3	Skaraborgs skytteförbund
------------	--------	--------------------------

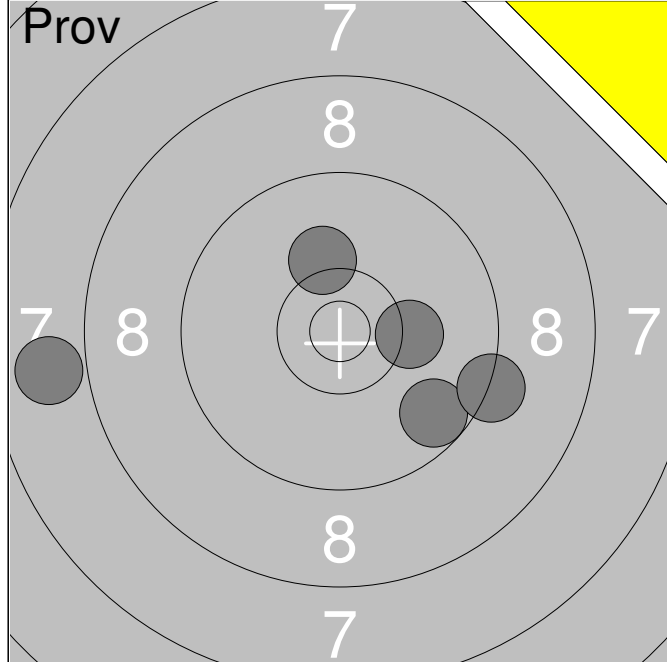

1:	10.2	↑
2:	9.7	↓
3:	9.3	→
4:	7.9	←
5:	10.2	→

Serie	45.0
Total	0.0

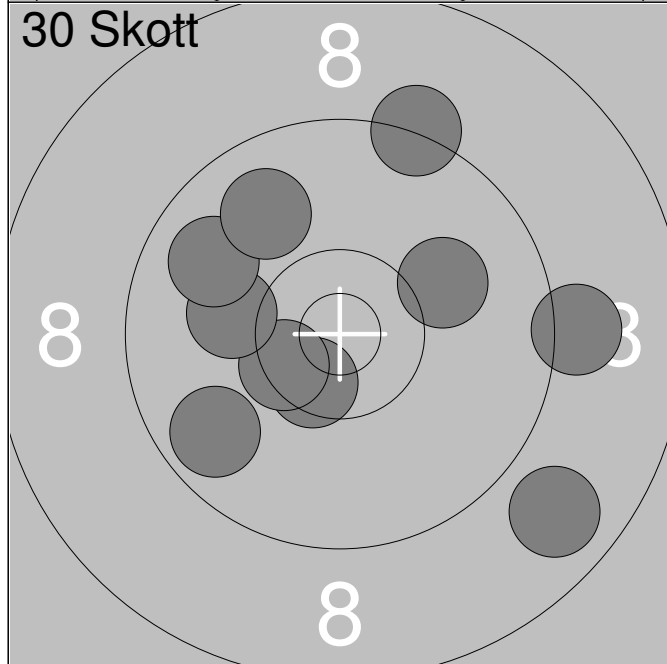

1:	10.5x	↓
2:	9.7	↙
3:	10.1	→
4:	8.8	↓
5:	10.5x	↙
6:	9.3	↑
7:	9.1	→
8:	10.1	←
9:	9.8	↗
10:	9.9	↗

Serie	93.0
Total	93.0

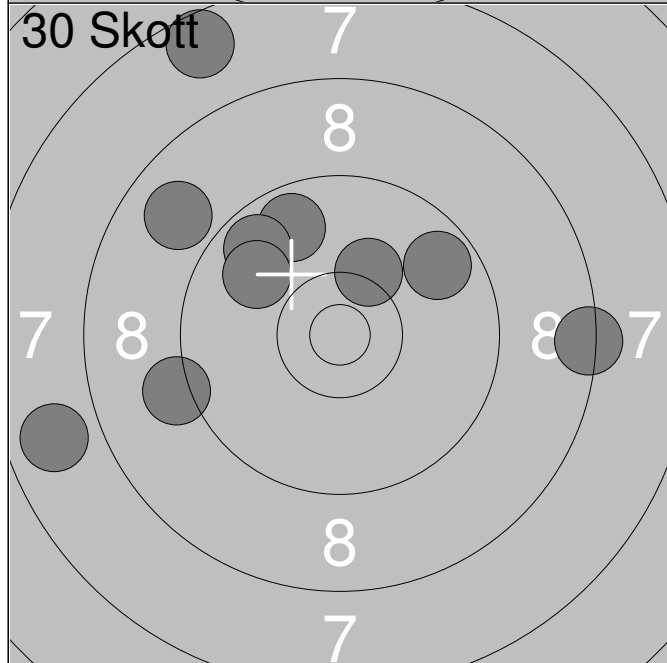

11:	8.4	→
12:	9.7	↗
13:	9.7	↗
14:	9.9	↗
15:	7.8	←
16:	9.2	←
17:	10.2	↗
18:	7.6	↗
19:	8.9	↗
20:	9.7	↗

Serie	85.0
Total	178.0

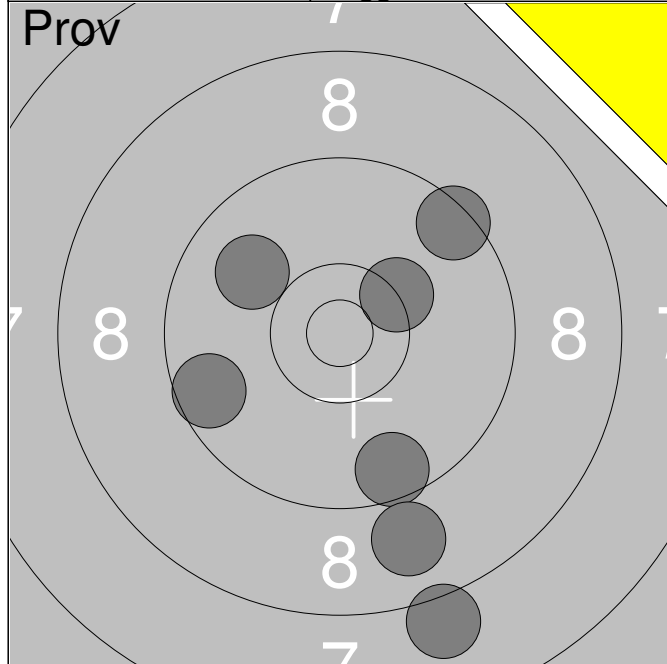

1:	9.9	↗
2:	9.6	↖
3:	9.6	↓
4:	8.1	↓
5:	10.3x	↗
6:	8.9	↓
7:	9.5	↗

Serie	62.0
Total	0.0

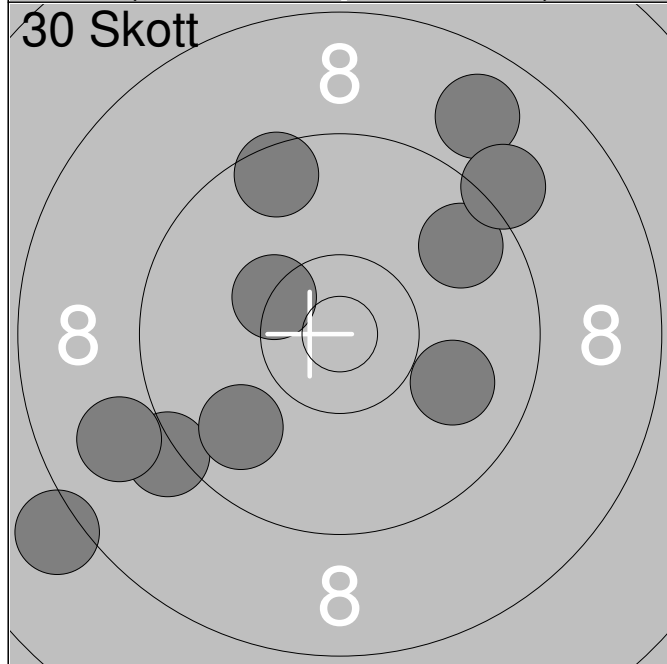

1:	9.7	↗
2:	10.3x	↖
3:	9.9	→
4:	8.8	↗
5:	9.1	↗
6:	9.2	↖
7:	8.9	↖
8:	9.5	↑
9:	9.8	↖
10:	8.1	↖

Serie	88.0
Total	88.0



11:	10.4x	↑
12:	9.2	↑
13:	7.9	↖
14:	8.7	↗
15:	10.1	↑
16:	10.2	↖
17:	9.2	↖
18:	9.3	↖
19:	10.2	↖
20:	7.4	↖

Serie	89.0
Total	177.0

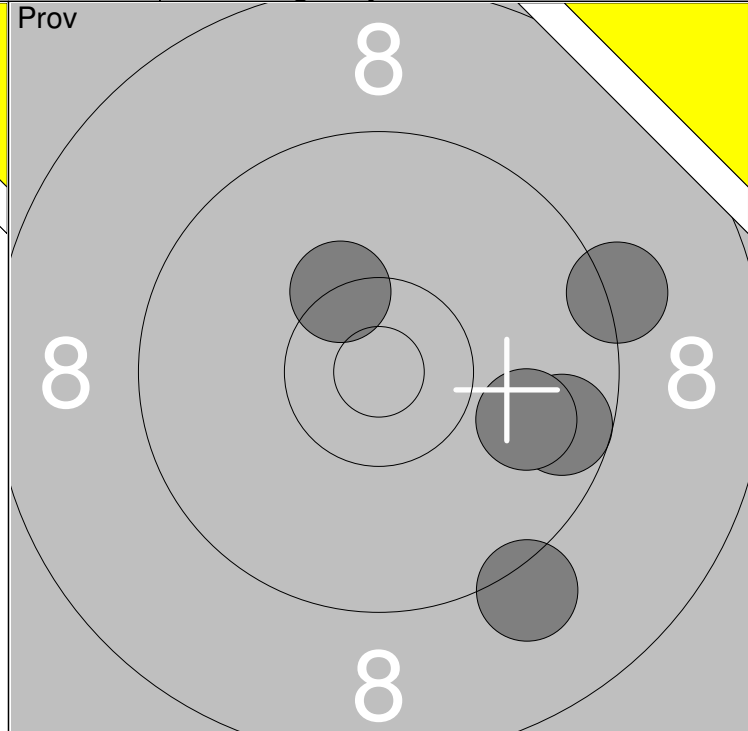
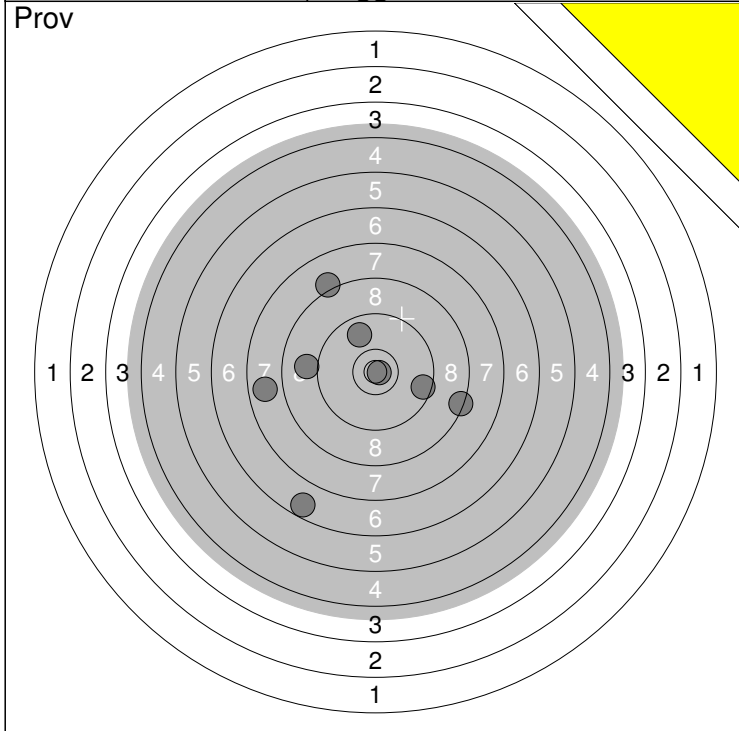

1: 8.1 ↗	7: 7.8 ←	Serie	66
2: 6.7 ↘	8: 8.4 →		
3: 9.0 ←	9: 10.8x →	Total	0
5: 9.8 ↗	10: 9.5 →		
6: 0.0 ↗			

11: 10.3x ↗	Serie	46
12: 9.6 →		
13: 9.2 →	Total	0
14: 9.1 ↘		
15: 9.9 →		

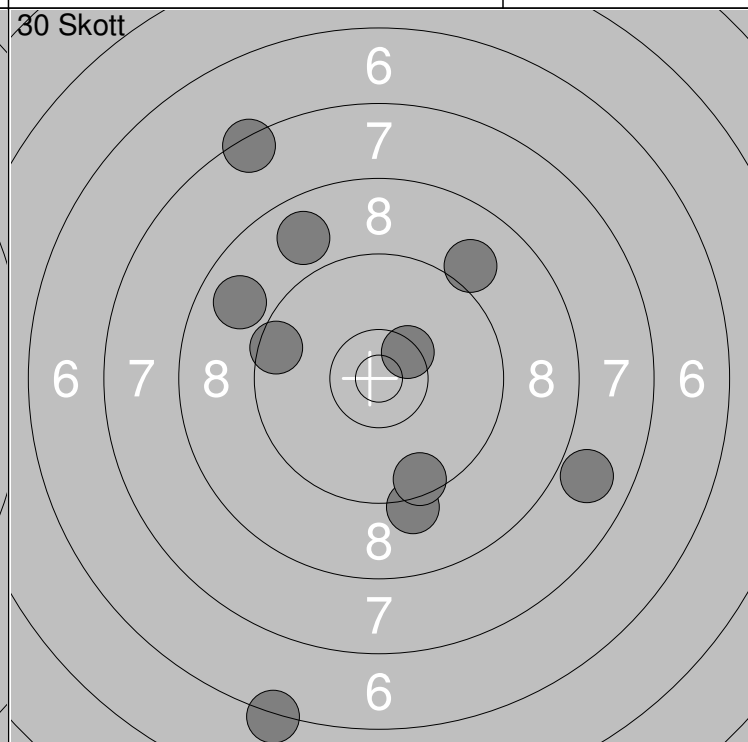
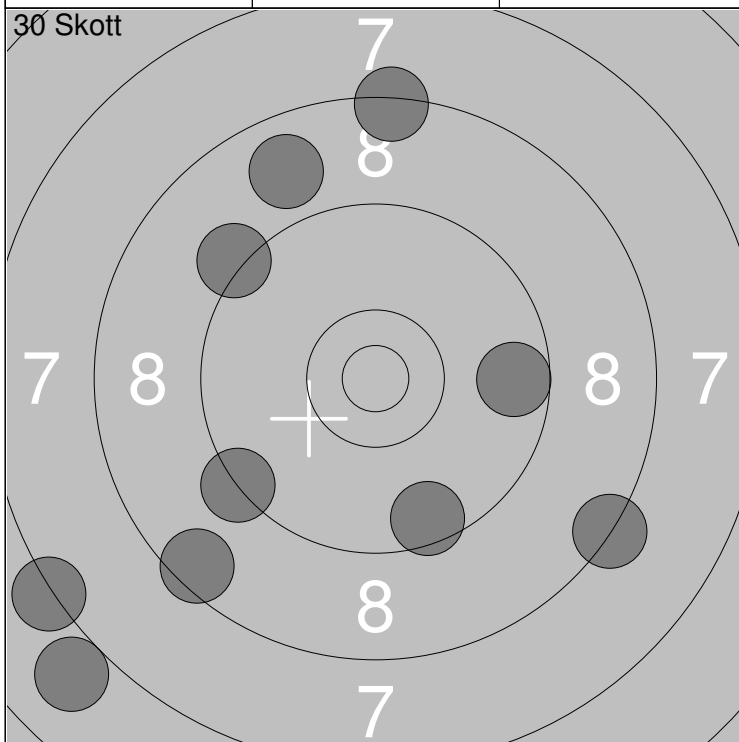

1: 9.3 ↖	6: 9.6 →	Serie	82
2: 7.0 ↖	7: 7.3 ↖		
3: 8.5 ↖	8: 8.4 ↑	Total	82
4: 8.8 ↗	9: 9.2 ↗		
5: 9.5 ↘	10: 8.3 ↘		

11: 7.9 →	Serie	82
12: 9.2 ↘		
13: 7.4 ↗	Total	164
14: 8.8 ↗		
15: 9.5 ↘		

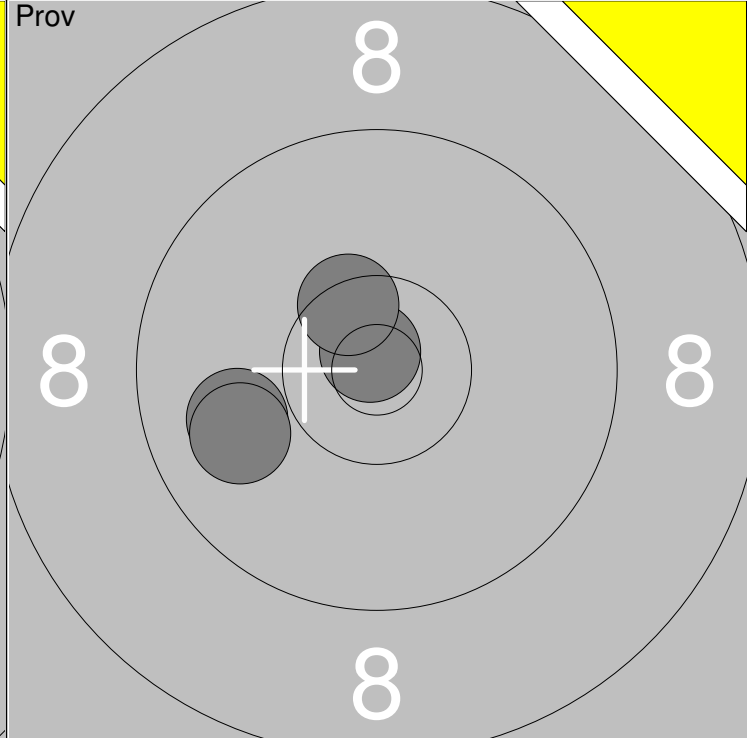
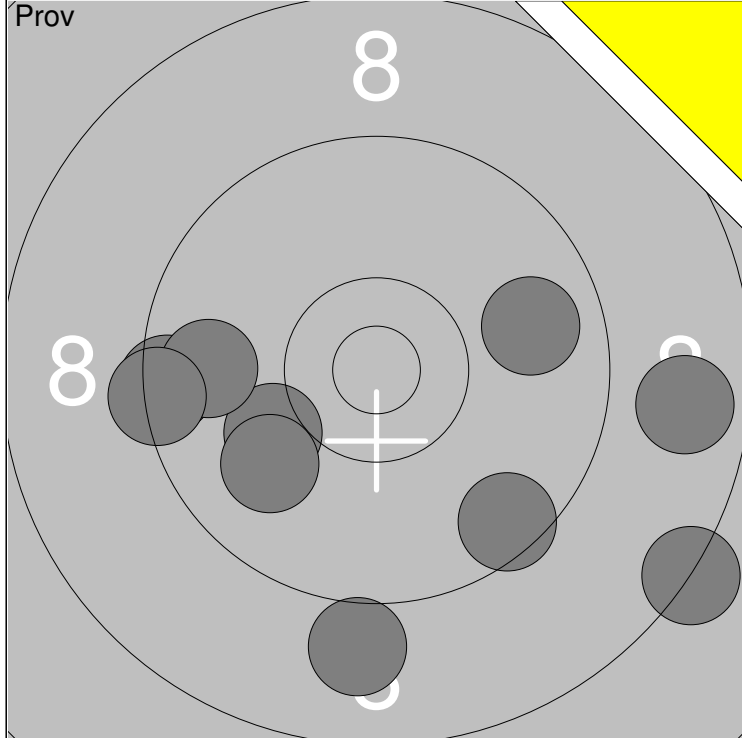

1: 8.3 ↘	6: 9.5 ←	Serie	89
2: 8.8 →	7: 10.1 ↙		
3: 9.5 ↘	8: 9.9 ↙	Total	0
4: 9.8 →	9: 9.8 ←		
5: 9.0 ↓	10: 9.4 ←		

11: 9.9 ←	Serie	38
12: 9.9 ←		
13: 10.8x ↗	Total	0
14: 10.5x ↗		

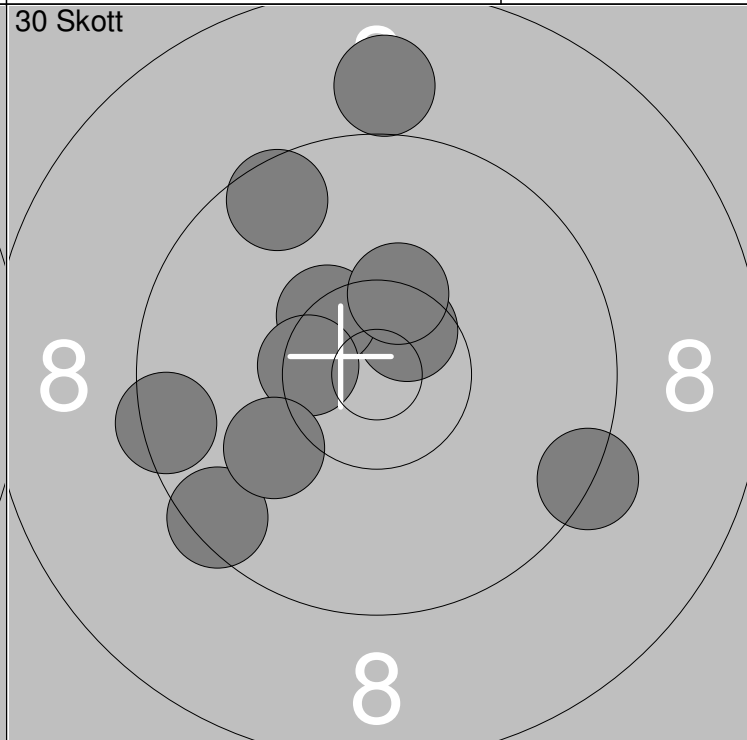
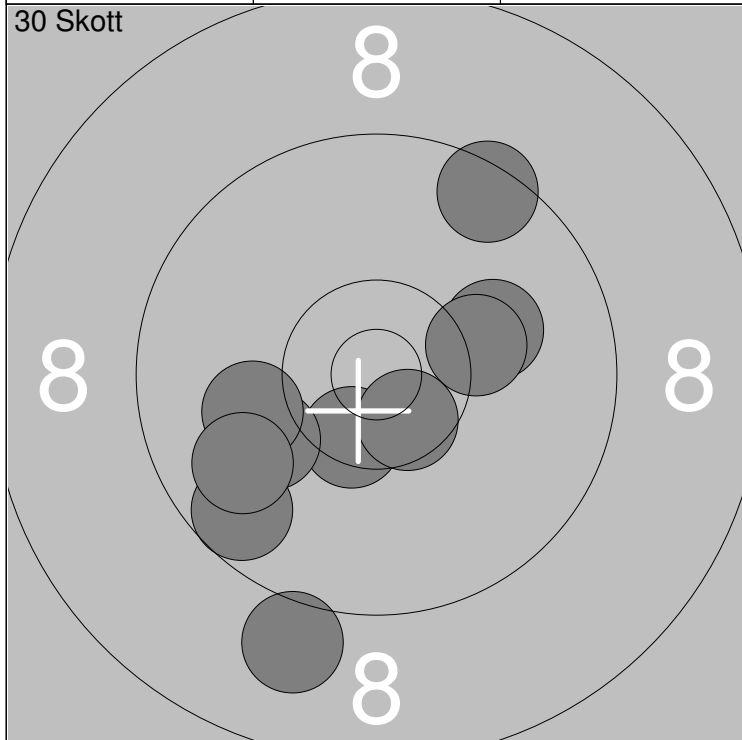

1: 10.1 →	6: 10.2 →	Serie	96
2: 9.0 ↓	7: 10.1 ↙		
3: 10.5x ↘	8: 10.1 ←	Total	96
4: 9.6 ↙	9: 10.6x ↘		
5: 9.5 ↗	10: 9.8 ↙		

11: 10.6x ↗	16: 9.6 ↖	Serie	95
12: 9.5 ←	17: 10.4x ↗		
13: 9.0 ↑	18: 10.5x ←	Total	191
14: 9.5 ↙	19: 9.3 →		
15: 10.4x ↖	20: 10.1 ↙		

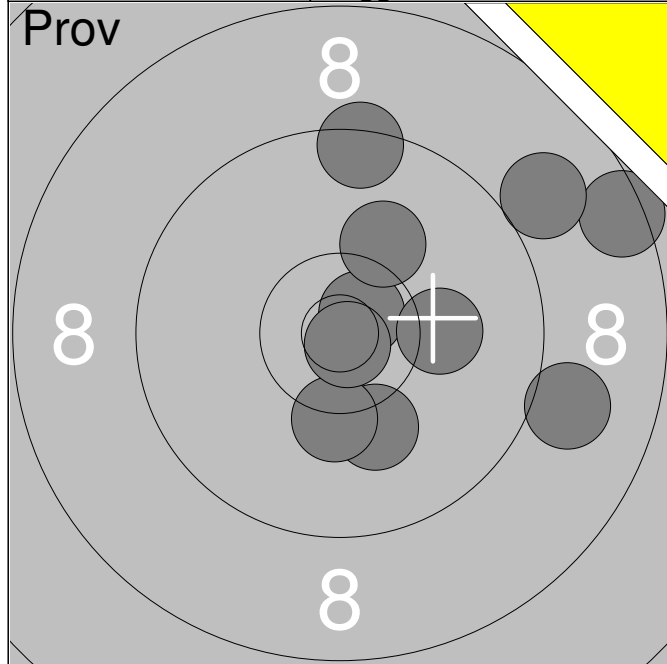

1:	9.0	→
2:	10.1	↓
3:	8.5	→
4:	9.4	↑
5:	9.0	↗
6:	10.3	↓
7:	10.7x	↗
8:	10.1	↑
9:	10.1	→
10:	10.8x	↓

Serie		95.0
Total		0.0

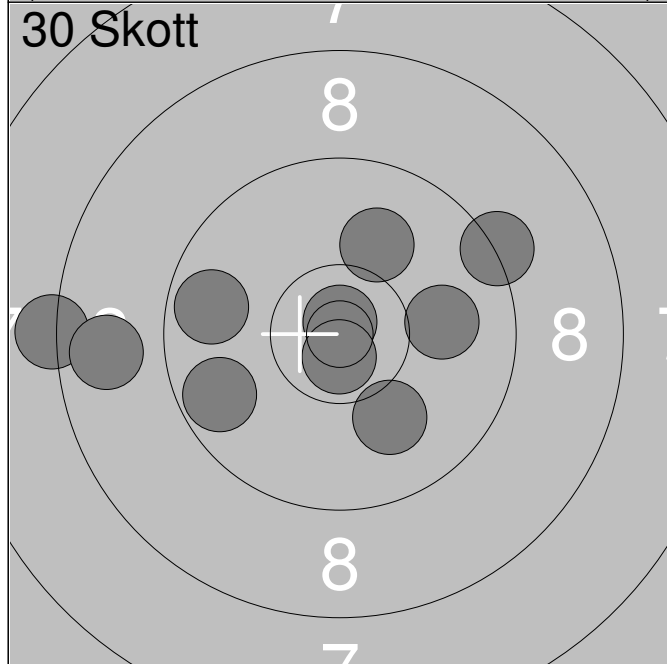

1:	10.0	↓
2:	10.8x	↑
3:	10.7x	↓
4:	8.3	←
5:	8.8	←
6:	9.3	↗
7:	9.7	←
8:	10.0	→
9:	10.0	↑
10:	9.7	↙

Serie		93.0
Total		93.0

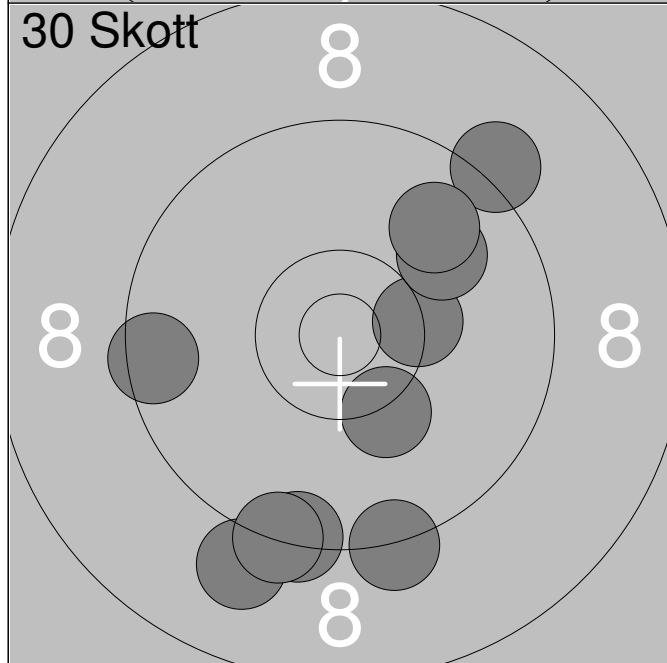

11:	9.0	↓
12:	9.2	↗
13:	9.3	↓
14:	9.4	↓
15:	10.3x	→
16:	10.0	↗
17:	9.3	↓
18:	9.9	↗
19:	9.5	←
20:	10.3	↓

Serie		93.0
Total		186.0

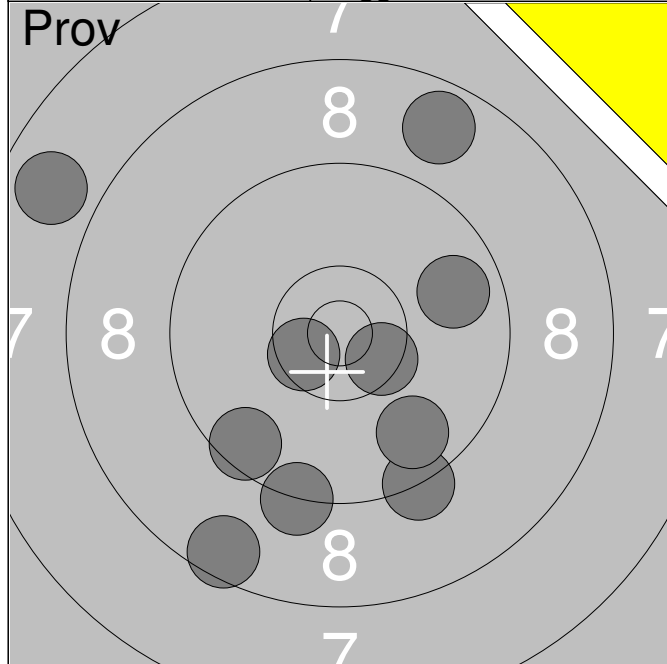

1:	10.5x	↙
2:	9.8	→
3:	9.3	↓
4:	9.3	↓
5:	9.8	↘
6:	8.7	↑
7:	7.8	↖
8:	8.5	↓
9:	10.5x	↘
10:	9.5	↙

Serie	88.0
Total	0.0

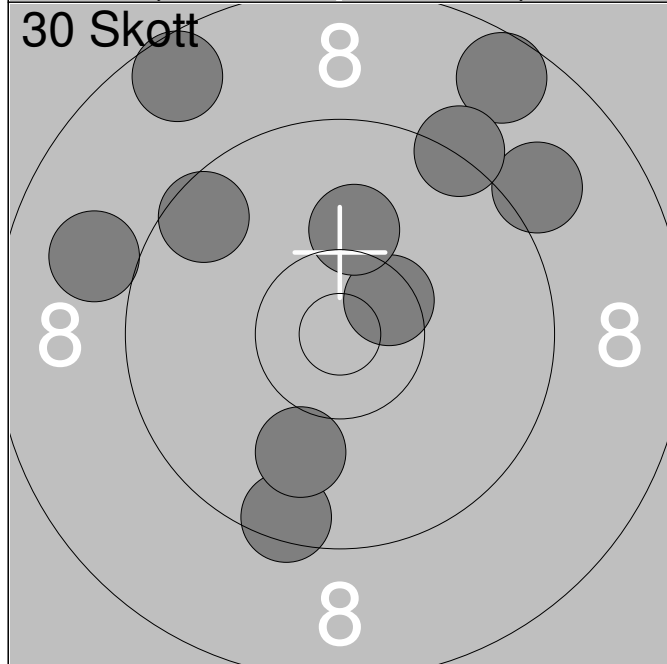

1:	10.5x	↗
2:	8.6	↖
3:	9.1	↗
4:	9.6	↖
5:	9.0	↙
6:	8.6	↗
7:	9.3	↗
8:	9.5	↓
9:	10.0	↓
10:	10.1	↑

Serie	91.0
Total	91.0



11:	9.2	↓
12:	8.5	↑
13:	7.6	↑
14:	9.0	↖
15:	9.3	↙
16:	9.8	↗
17:	9.7	↗
18:	8.4	↑
19:	8.9	↖
20:	9.8	↖

Serie	85.0
Total	176.0

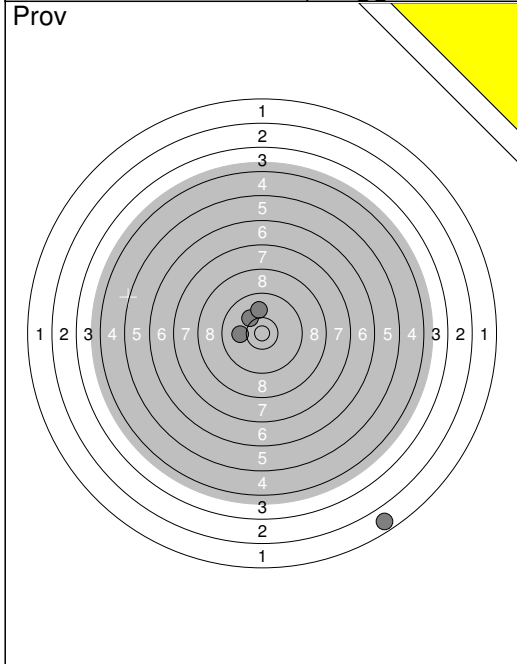

2:	1.7	↘
3:	0.0	↖
8:	10.1	↗
9:	10.1	←
10:	10.0	↑
Serie	31.0	
Total	0.0	

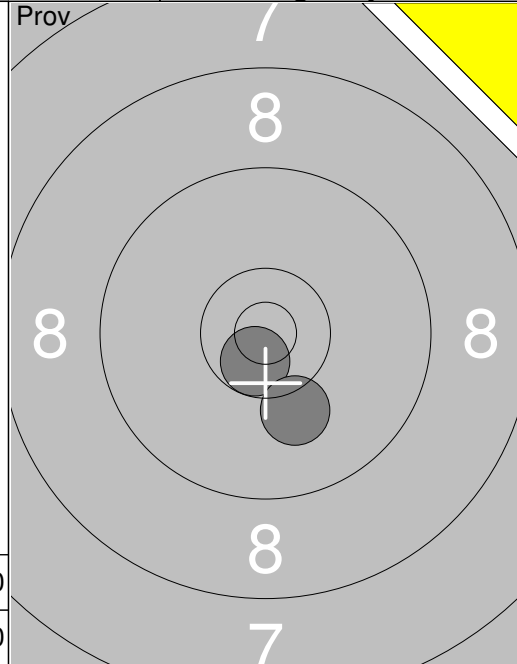

11:	10.6x	↘
12:	10.1	↘
Serie	20.0	
Total	0.0	

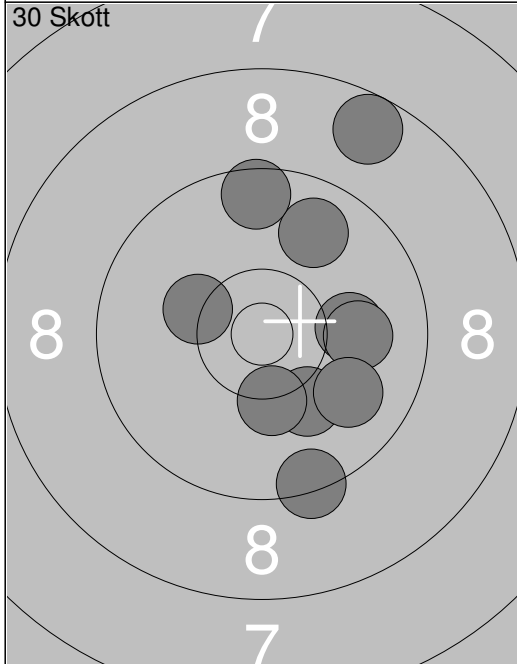

1:	9.8	↗
2:	10.1	→
3:	10.1	↘
4:	10.0	→
5:	8.6	↗
6:	9.6	↑
7:	10.3	↘
8:	9.9	↘
9:	9.4	↘
10:	10.3	↖
Serie	94.0	
Total	94.0	

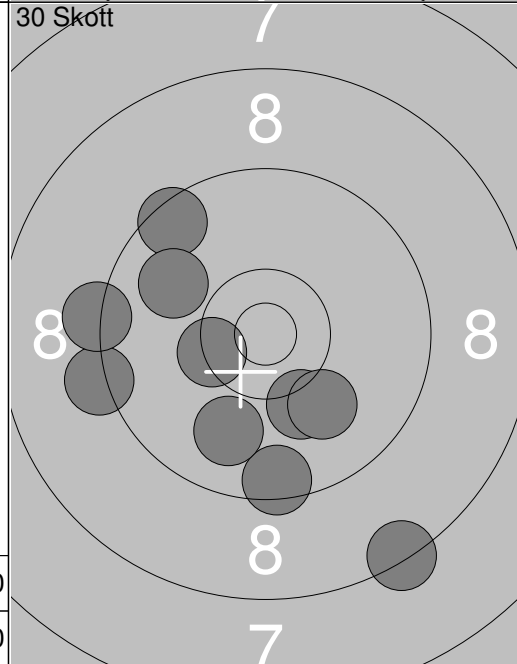

11:	10.2	↘
12:	9.5	↗
13:	8.4	↘
14:	9.2	←
15:	9.3	←
16:	10.1	↘
17:	9.5	↘
18:	9.9	↖
19:	9.9	↘
20:	10.4x	↖
Serie	92.0	
Total	186.0	

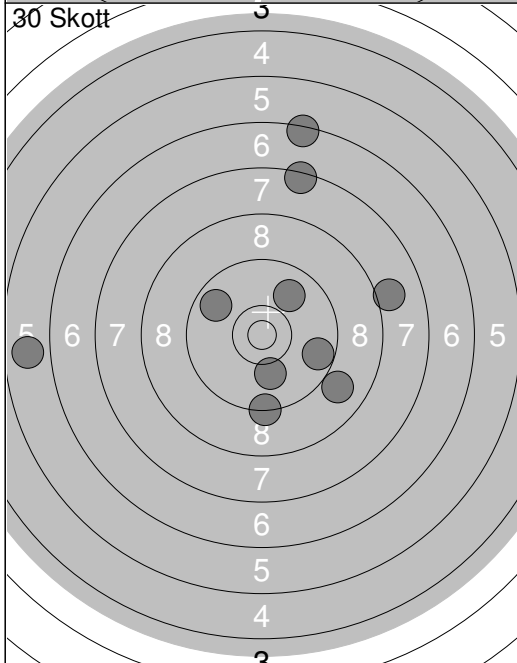

21:	8.0	→
22:	5.8	←
23:	9.3	↘
24:	9.8	↖
25:	6.4	↑
26:	9.9	↗
27:	8.9	↘
28:	10.1	↘
29:	7.4	↑
30:	9.7	→
Serie	80.0	
Total	266.0	

Prov 	1: 9.3 ↗ 2: 10.1 ↓ 3: 9.5 → 4: 9.7 ← 5: 9.9 → 6: 10.5x ↗ 7: 9.7 ↓ 8: 9.6 ↗ 9: 9.9 → 10: 10.1 ↖	Prov 	11: 9.5 ↓ 12: 10.1 ↗ 13: 9.9 ↖ 14: 9.9 →
Serie	93.0	Serie	37.0
Total	0.0	Total	0.0

30 Skott 	1: 10.5x ↓ 2: 10.2 ← 3: 10.5x ↙ 4: 10.0 ↓ 5: 10.2 → 6: 9.1 ↓ 7: 9.9 ↗ 8: 9.8 ↗ 9: 10.2 ↓ 10: 10.2 ←	30 Skott 	11: 10.5x ↖ 12: 10.5x ↓ 13: 9.9 → 14: 10.1 ↗ 15: 10.2 ↗ 16: 9.8 → 17: 10.4x ↖ 18: 10.0 ↓ 19: 9.6 ← 20: 9.3 ↖
Serie	97.0	Serie	96.0
Total	97.0	Total	193.0

30 Skott 	21: 7.6 ↓ 22: 10.5x ↙ 23: 9.7 ↖ 24: 9.4 ↗ 25: 7.2 → 26: 9.6 ↗ 27: 9.8 ↗ 28: 8.6 ↓ 29: 7.4 → 30: 8.4 ↗		
Serie	83.0		
Total	276.0		

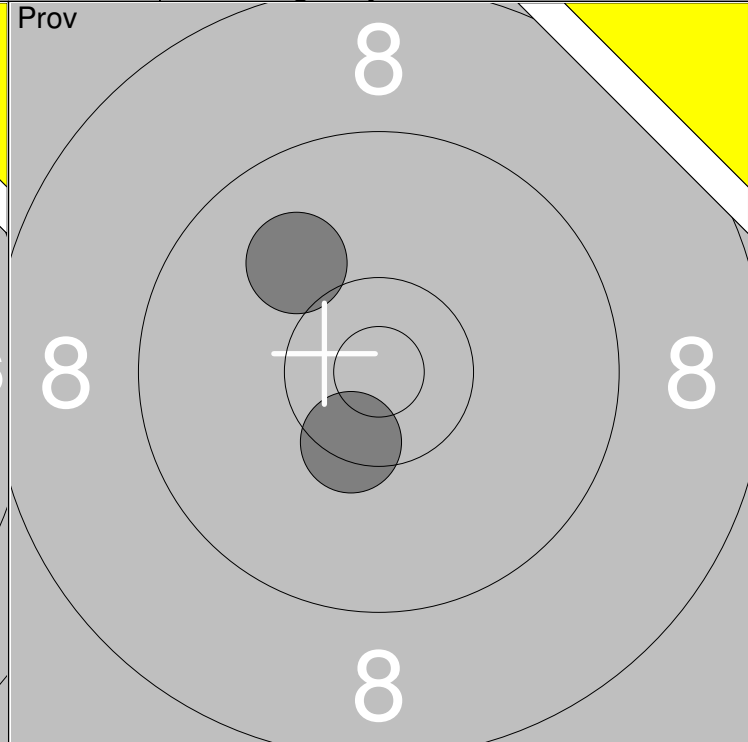
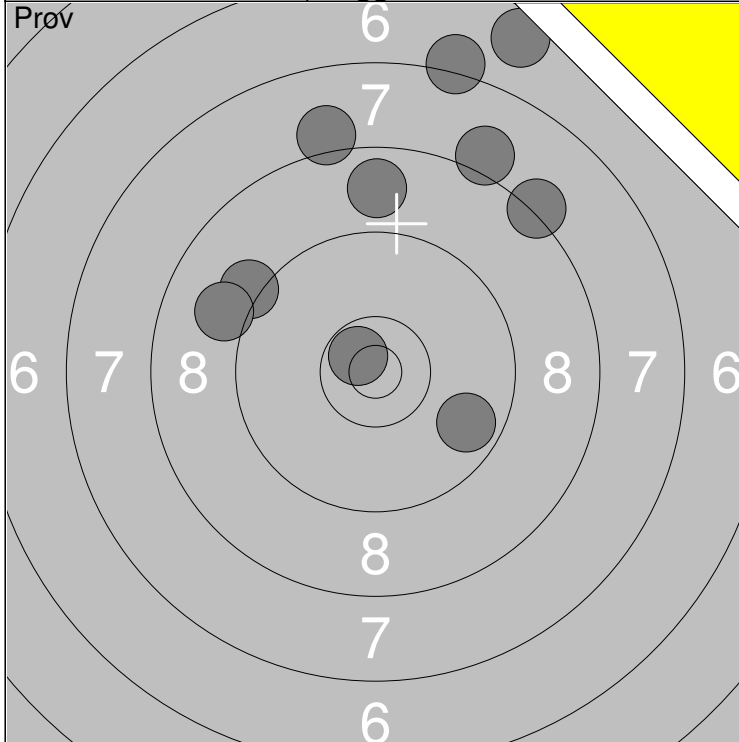

1: 7.2 ↑	6: 10.7x ↗	Serie	82
2: 8.2 ↗	7: 9.2 ↗		
3: 8.1 ↗	8: 8.8 ↑	Total	0
4: 6.6 ↗	9: 9.0 ↖		
5: 8.1 ↑	10: 9.7 ↘		

11: 10.0 ↖	Serie	20
12: 10.4x ↘		
Total		0

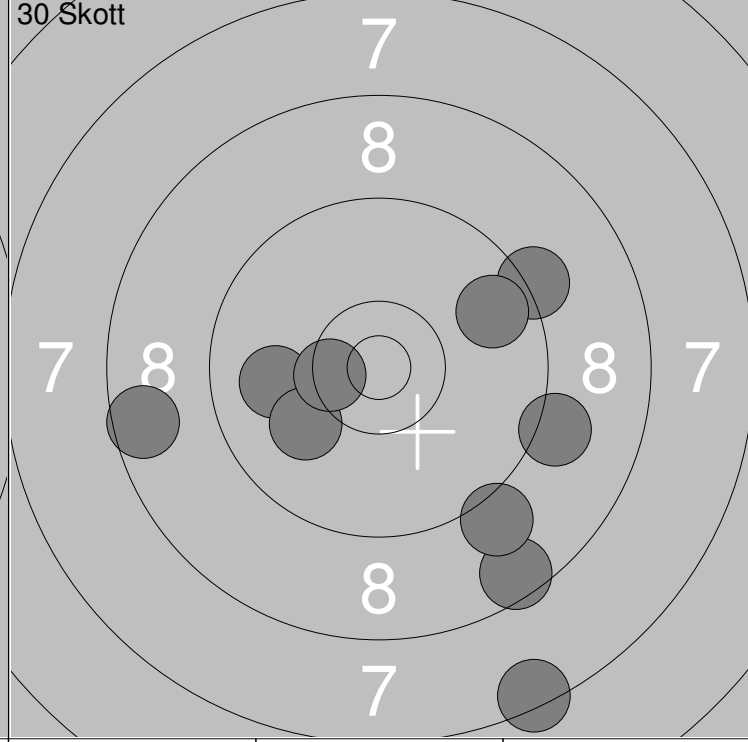
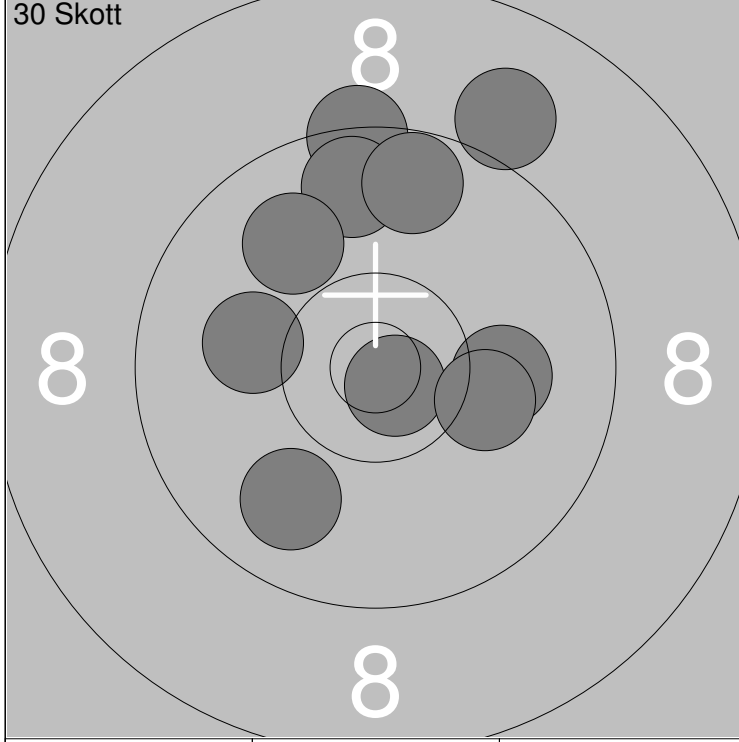

1: 9.4 ↑	6: 10.8x ↘	Serie	94
2: 9.7 ↑	7: 9.9 ↘		
3: 10.1 →	8: 9.7 ↑	Total	94
4: 9.0 ↗	9: 10.2 →		
5: 10.1 ←	10: 9.9 ↗		

11: 9.9 ←	16: 10.5x ←	Serie	88
12: 10.1 ↖	17: 9.7 ↗		
13: 8.6 ←	18: 9.1 →	Total	182
14: 8.5 ↘	19: 9.1 ↘		
15: 9.2 ↗	20: 7.4 ↘		

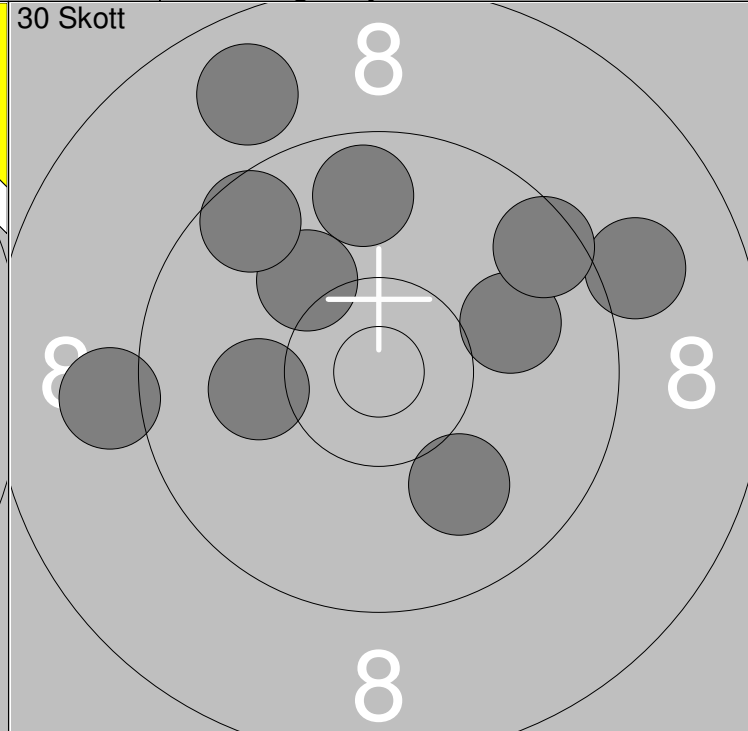
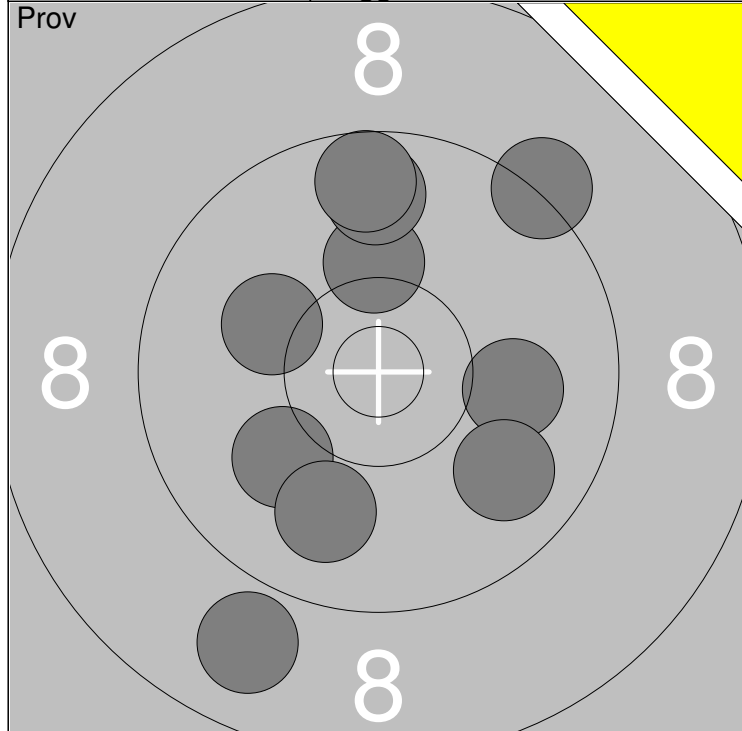

1: 10.0 →	6: 9.9 ↘	Serie	93
2: 8.9 ↘	7: 9.6 ↑		
3: 10.2 ↑	8: 9.9 ↘	Total	0
4: 9.7 ↑	9: 10.1 ↖		
5: 10.1 ↙	10: 9.3 ↗		

1: 10.0 ↘	6: 9.5 ↗	Serie	93
2: 10.1 ←	7: 10.2 ↗		
3: 9.0 →	8: 9.1 ←	Total	93
4: 10.0 →	9: 8.8 ↑		
5: 9.7 ↑	10: 9.6 ↘		

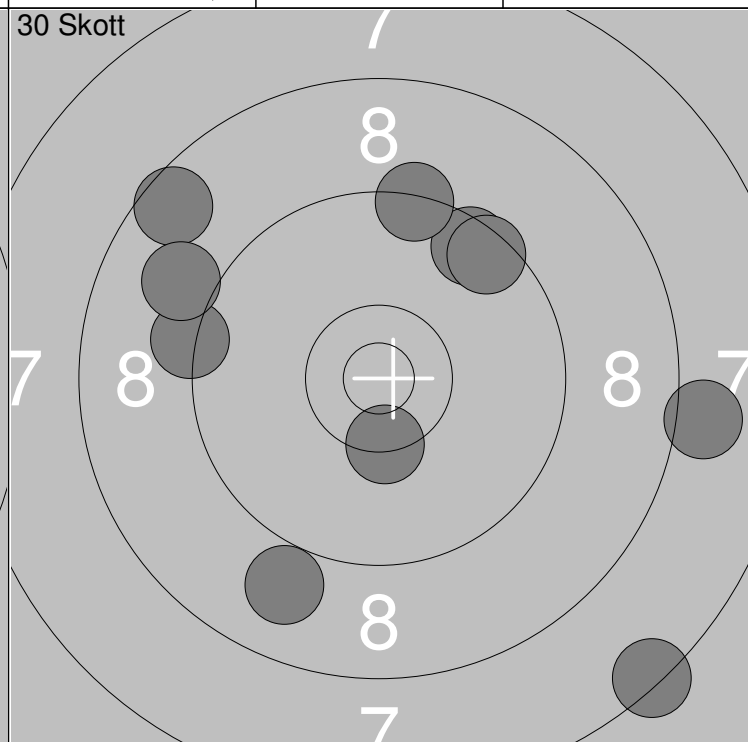
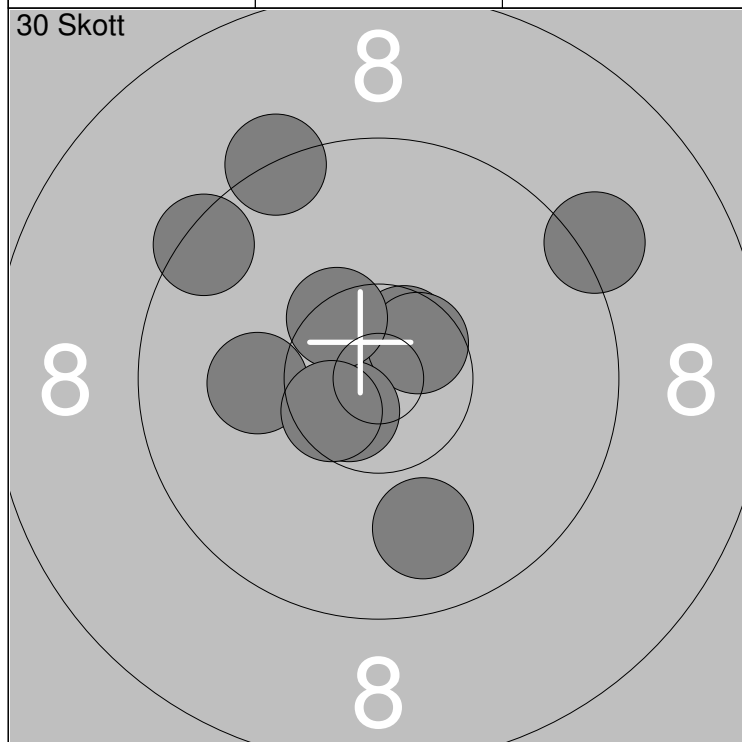

11: 10.1 ←	16: 10.6x ↘	Serie	96
12: 10.6x ↗	17: 10.4x ↗		
13: 9.3 ↗	18: 9.4 ↖	Total	189
14: 9.2 ↗	19: 9.9 ↘		
15: 10.6x ↗	20: 10.6x ↙		

21: 8.9 ↘	26: 9.5 ↗	Serie	86
22: 7.4 ↘	27: 8.6 ↖		
23: 10.4x ↘	28: 9.4 ↑	Total	275
24: 9.5 ↗	29: 9.2 ←		
25: 8.1 →	30: 9.0 ↖		

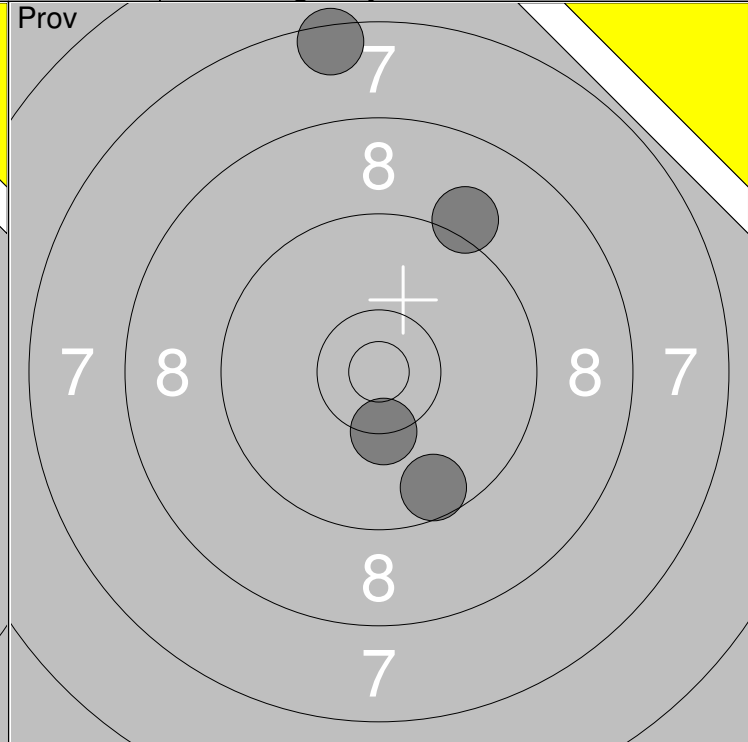
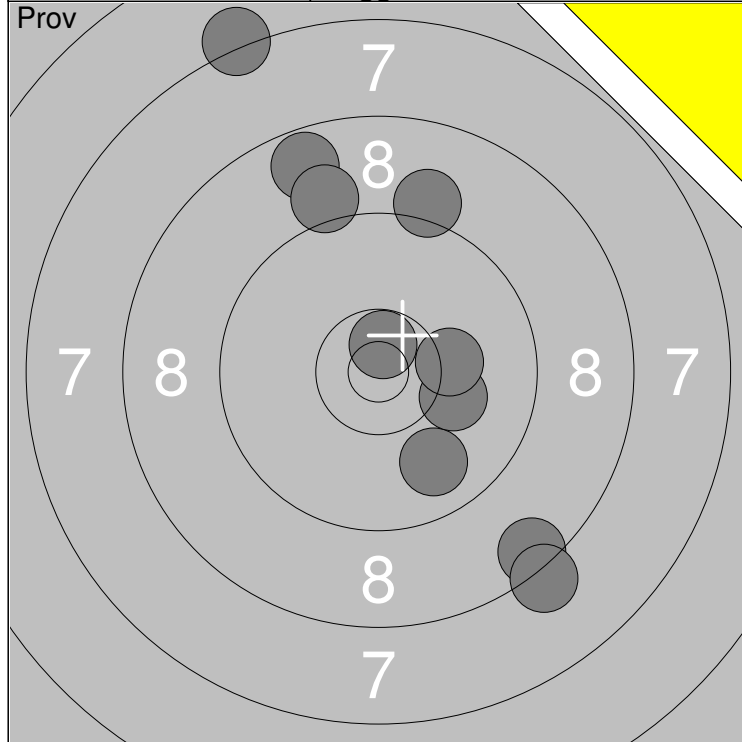

1: 9.1	↑	6: 10.2	→	Serie	88
2: 9.9	↓	7: 8.7	↑		
3: 8.5	↓	8: 9.1	↑	Total	0
4: 10.1	↓	9: 10.7x	↑		
5: 8.2	↓	10: 7.2	↑		

11: 9.1	↗	Serie	35
12: 7.5	↑		
13: 9.6	↓	Total	0
14: 10.3x	↓		

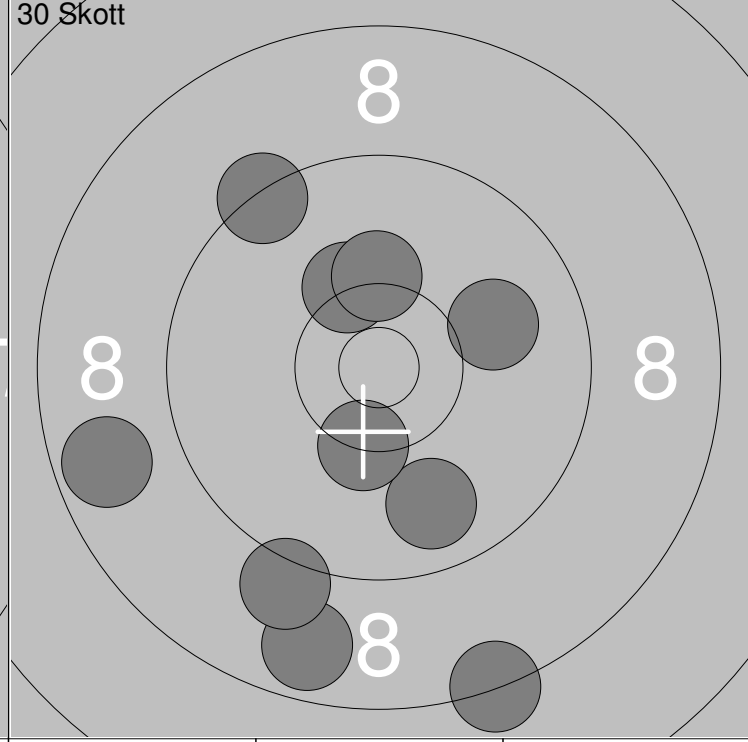
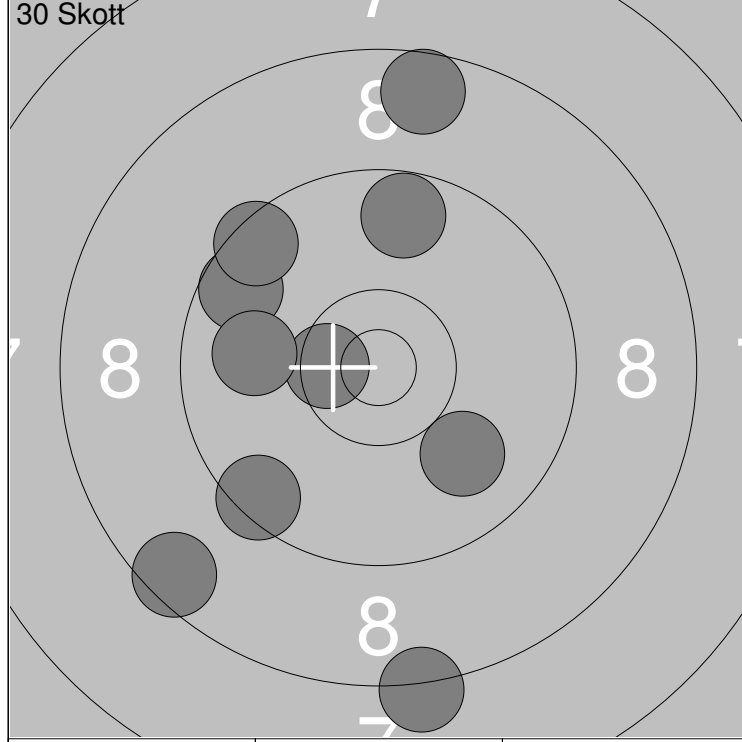

1: 9.7	↑	6: 9.5	↙	Serie	89
2: 10.0	↓	7: 8.2	↓		
3: 8.6	↑	8: 10.5x	←	Total	89
4: 9.6	↖	9: 9.9	←		
5: 9.5	↖	10: 8.5	↙		

11: 8.7	↓	16: 10.3x	↓	Serie	91
12: 9.8	↓	17: 9.1	↓		
13: 8.3	↓	18: 10.3	↑	Total	180
14: 8.7	←	19: 10.2	↑		
15: 9.4	↖	20: 10.0	→		

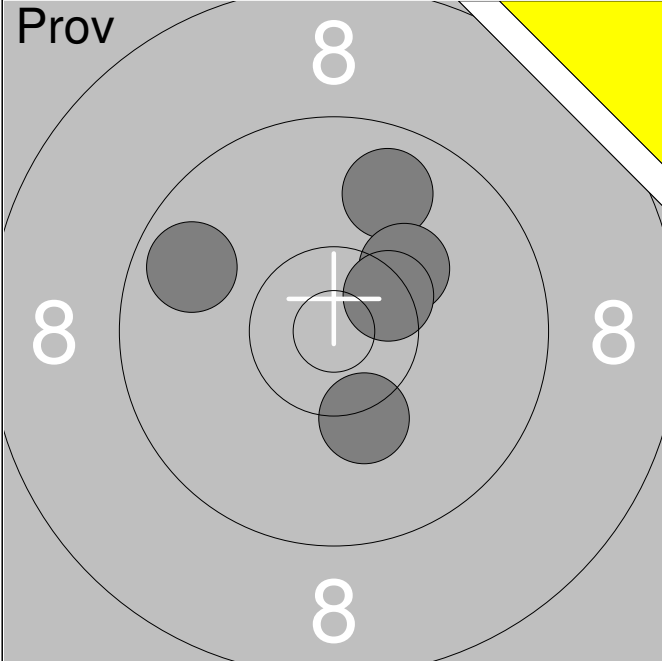
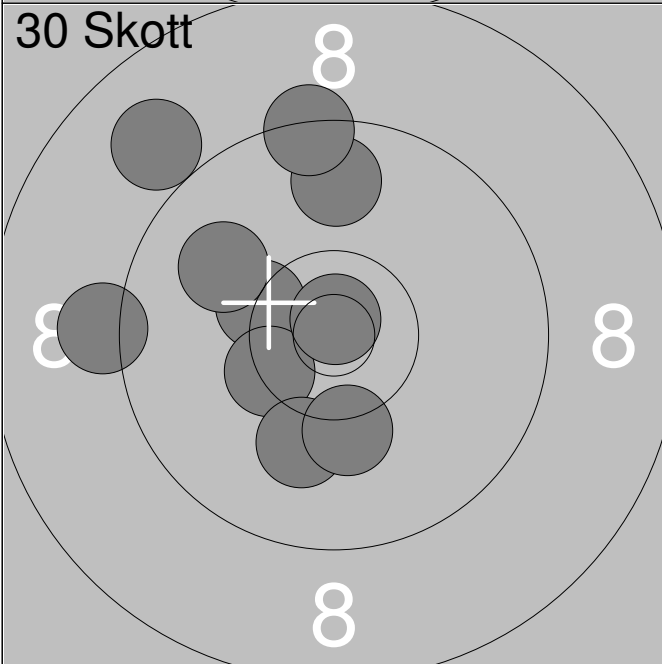
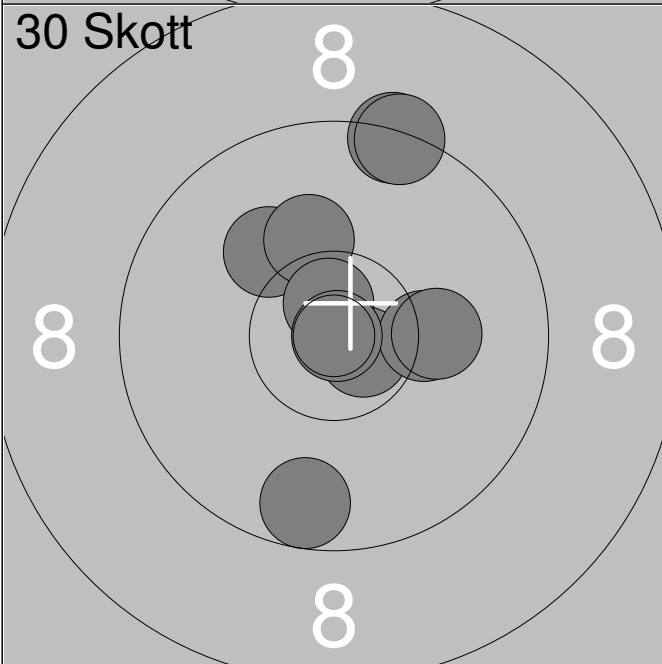
Skjutlag	Tavla	KASPER SVENSSON	
3	6		
50m	Skölvene/Ölanda Skf	K 4	
27.06.2018	Mugg 3	Skaraborgs skytteförbund	
Prov 	1:	9.8	↑
	2:	10.2	↗
	3:	10.4x	↗
	4:	9.8	↖
	5:	10.2	↓
	Serie	48.0	
	Total	0.0	
30 Skott 	1:	9.2	←
	2:	8.9	↗
	3:	10.3x	↖
	4:	10.4x	←
	5:	10.1	↓
	6:	10.0	↖
	7:	9.8	↑
	8:	9.4	↑
	9:	10.8x	↑
	10:	10.2	↓
	Serie	95.0	
	Total	95.0	
30 Skott 	11:	9.4	↑
	12:	10.1	↗
	13:	10.7x	↘
	14:	10.2	↑
	15:	10.3	→
	16:	9.6	↓
	17:	10.7x	↑
	18:	10.9x	→
	19:	9.4	↑
	20:	10.2	→
	Serie	97.0	
	Total	192.0	

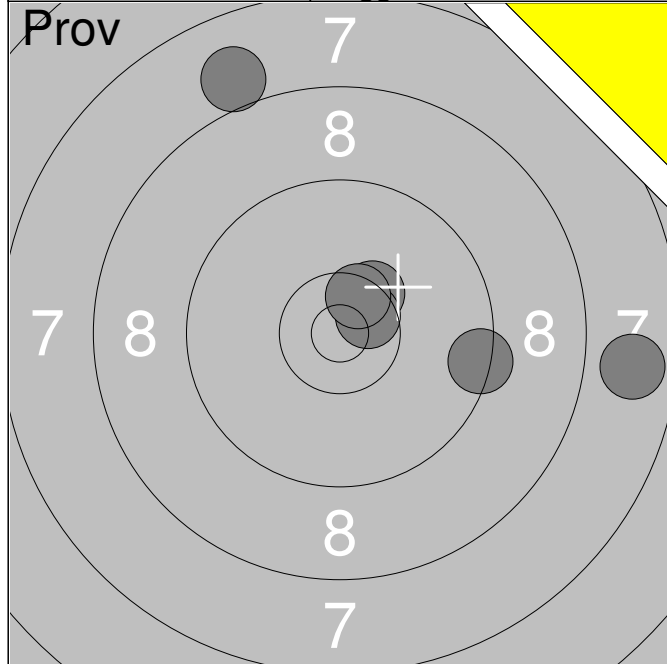

1:	10.4x	↗
2:	7.8	→
3:	9.4	→
4:	10.6x	↗
5:	8.0	↗
6:	10.5x	↗

Serie	54.0
Total	0.0

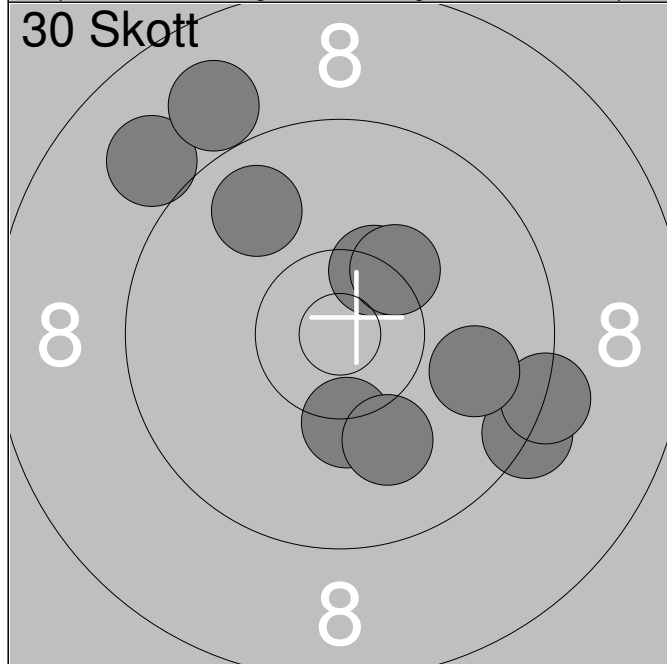

1:	9.0	↗
2:	8.9	↗
3:	9.8	↗
4:	10.4x	↗
5:	9.3	↘
6:	9.3	↘
7:	10.3	↘
8:	10.1	↘
9:	10.3x	↗
10:	9.9	→

Serie	93.0
Total	93.0

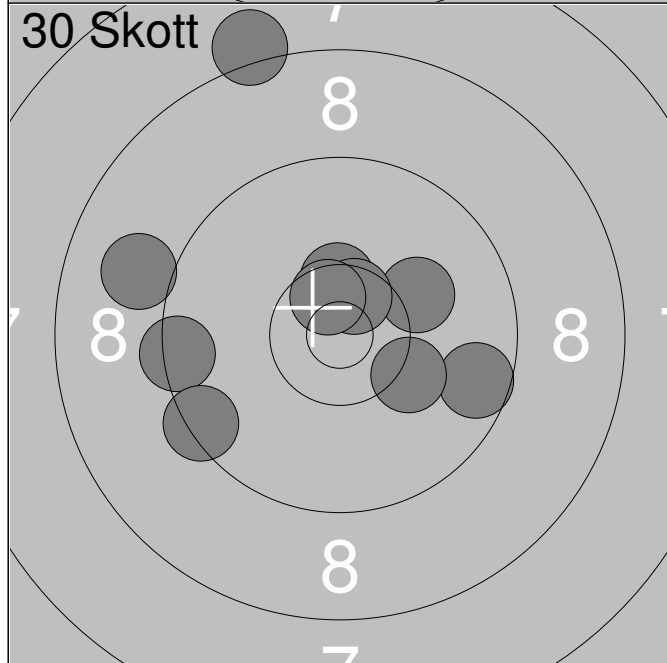

11:	9.6	→
12:	9.4	←
13:	10.1	↗
14:	8.2	↗
15:	9.4	↖
16:	10.4x	↗
17:	10.2	↘
18:	10.6x	↗
19:	10.6x	↗
20:	9.0	←

Serie	94.0
Total	187.0

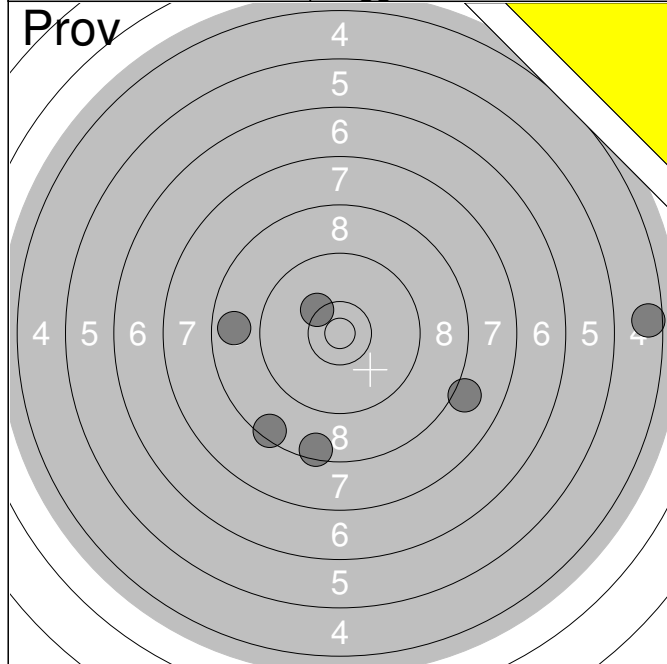

1:	8.1	→
2:	8.5	↓
3:	4.6	→
4:	8.5	↓
5:	8.8	←
6:	10.3	↗

Serie	46.0
Total	0.0

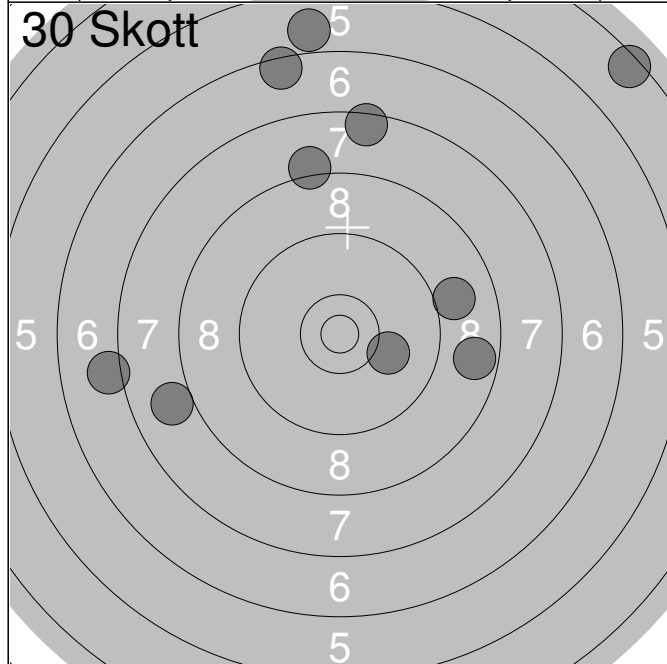

1:	8.0	←
2:	7.1	←
3:	4.5	↗
4:	6.5	↑
5:	9.0	→
6:	5.9	↑
7:	7.5	↑
8:	10.1	→
9:	8.7	→
10:	8.2	↑

Serie	72.0
Total	72.0

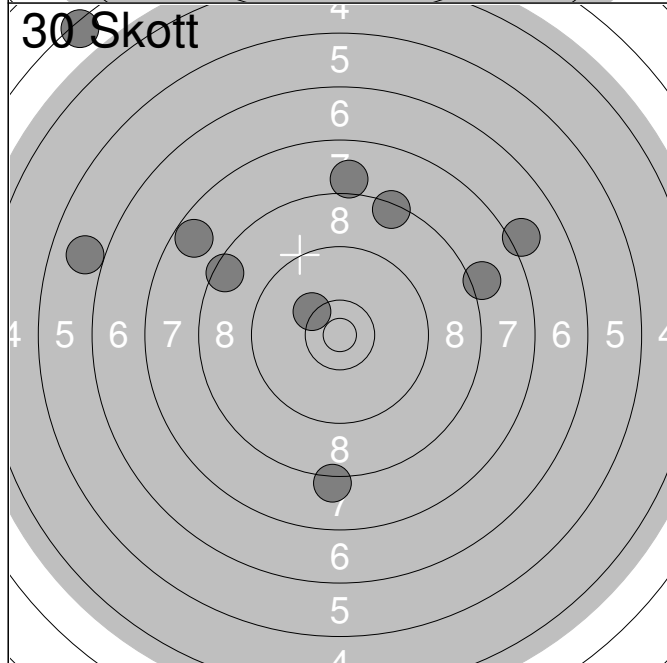

11:	5.9	←
12:	10.3	↗
13:	7.7	↗
14:	8.0	↑
15:	7.1	↗
16:	8.2	↓
17:	8.4	↑
18:	3.4	↗
19:	8.5	↗
20:	8.1	→

Serie	72.0
Total	144.0

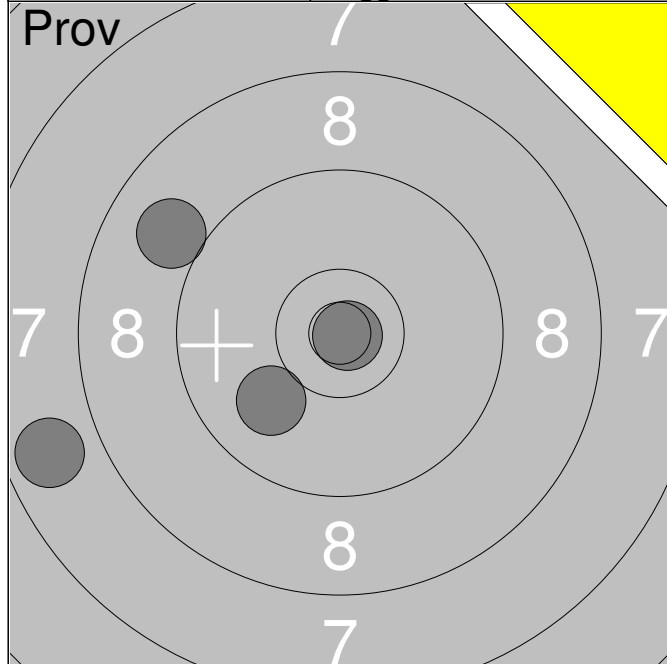

1:	7.8	←
2:	9.0	↗
3:	10.9x	→
4:	10.0	↙

Serie	36.0
Total	0.0

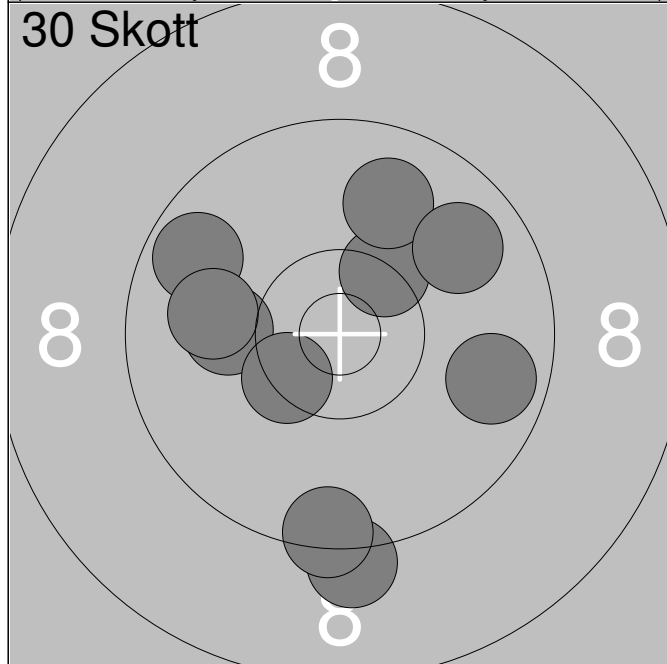

1:	9.2	↓
2:	10.1	←
3:	9.4	↓
4:	10.4x	↗
5:	9.7	↗
6:	10.0	←
7:	9.9	↑
8:	9.8	↗
9:	10.4x	↙
10:	9.7	→

Serie	94.0
Total	94.0

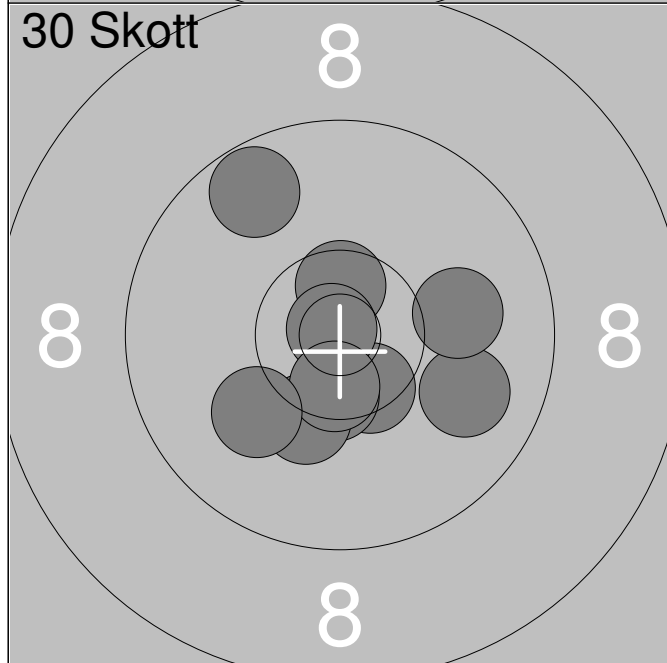

11:	10.5x	↓
12:	9.9	→
13:	10.0	→
14:	10.6x	↑
15:	10.5x	↓
16:	9.7	↗
17:	10.9x	↗
18:	10.3	↓
19:	10.6x	↓
20:	10.1	↙

Serie	98.0
Total	192.0

Skjutlag	Tavla	EMIL HULTSTRÖM	
3	10		

50m	Axvalls Skf	Support
-----	-------------	---------

27.06.2018	Mugg 3	Skaraborgs skytteförbund
------------	--------	--------------------------

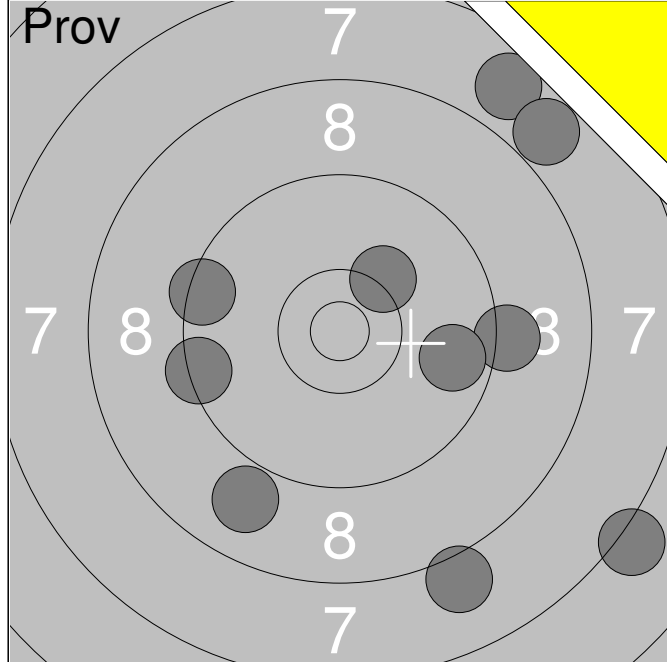

1:	9.4	←
2:	10.2	↗
3:	8.1	↓
4:	7.2	↓
5:	9.2	→
6:	7.8	↗
7:	7.9	↗
8:	9.7	→
9:	9.4	←
10:	8.9	↓

Serie	83.0
Total	0.0

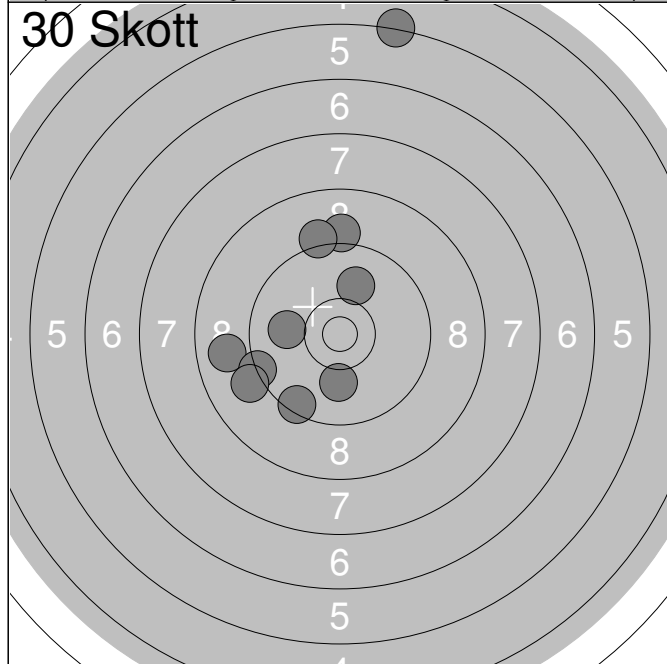

1:	10.0	↑
2:	9.4	↓
3:	8.9	←
4:	9.1	↑
5:	9.3	←
6:	10.1	↓
7:	9.2	↑
8:	5.3	↑
9:	10.0	←
10:	9.1	↙

Serie	88.0
Total	88.0

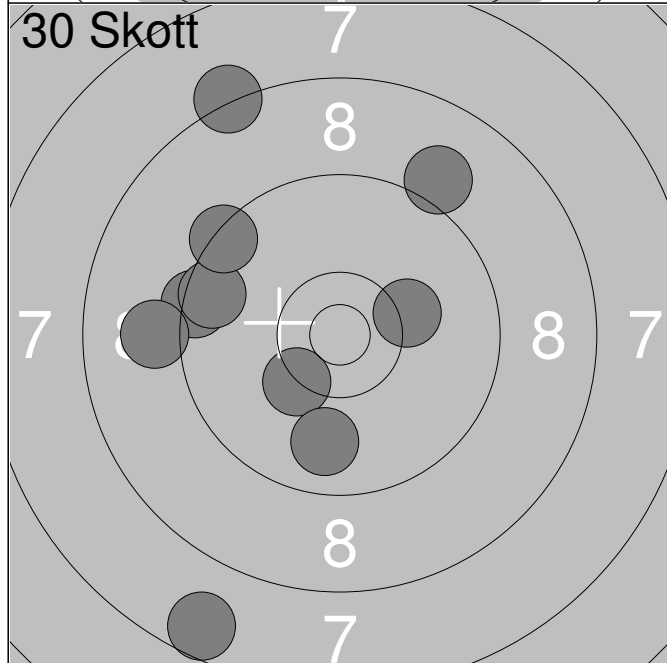

11:	9.4	←
12:	10.3x	↙
13:	7.6	↓
14:	9.0	←
15:	8.3	↗
16:	9.1	↗
17:	9.6	←
18:	9.8	↓
19:	10.2	→
20:	9.4	↖

Serie	89.0
Total	177.0

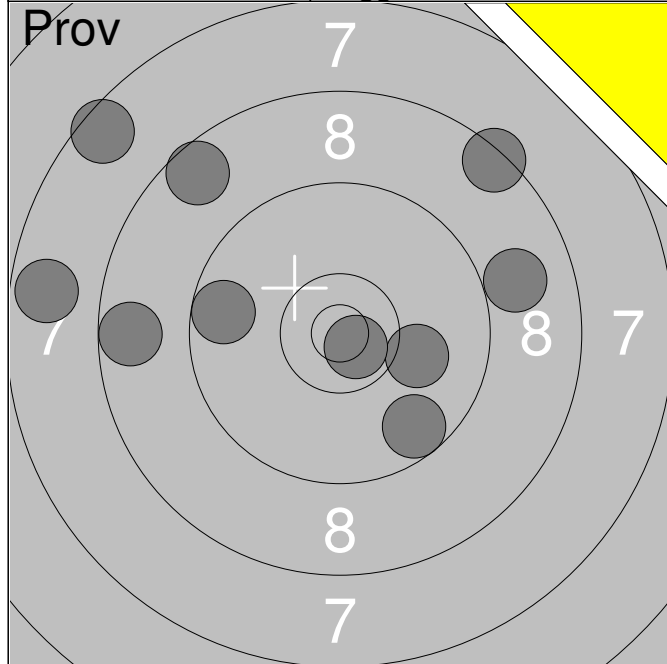

1:	8.6	↗
2:	7.5	↗
3:	8.7	←
4:	8.9	→
5:	10.1	→
6:	10.7x	↘
7:	7.7	←
8:	9.7	←
9:	8.4	↗
10:	9.6	↘

Serie	84.0
Total	0.0

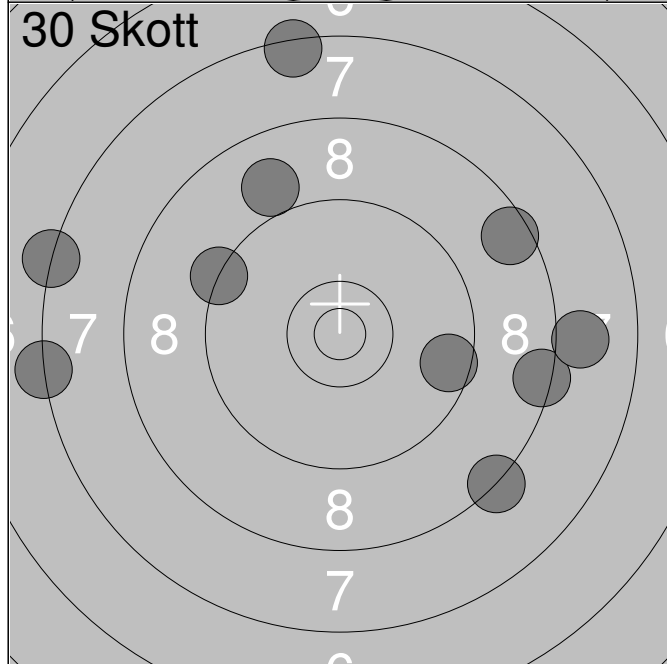

1:	7.4	↑
2:	8.5	↗
3:	8.4	→
4:	9.3	↗
5:	7.3	←
6:	8.0	→
7:	9.6	→
8:	9.0	↗
9:	7.3	←
10:	8.3	↘

Serie	80.0
Total	80.0

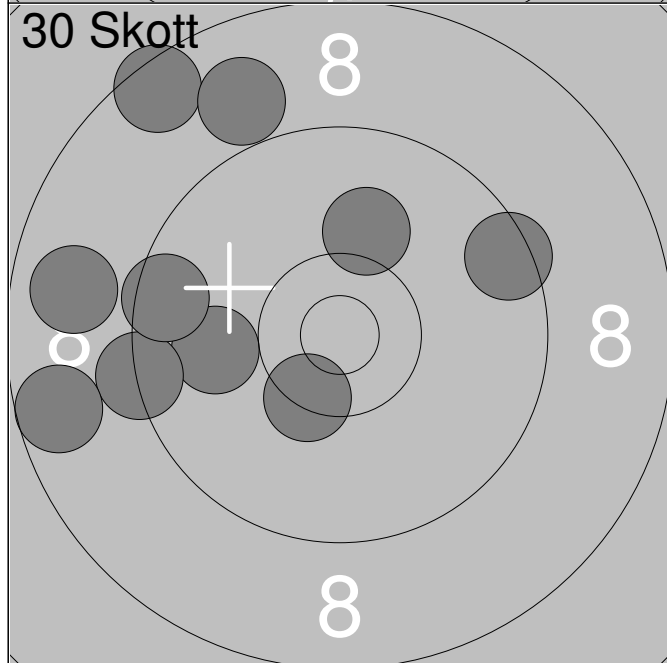

11:	10.1	↑
12:	10.0	←
13:	9.3	←
14:	10.4x	↘
15:	8.6	←
16:	9.5	→
17:	8.5	↗
18:	8.9	↗
19:	8.8	←
20:	9.5	←

Serie	89.0
Total	169.0

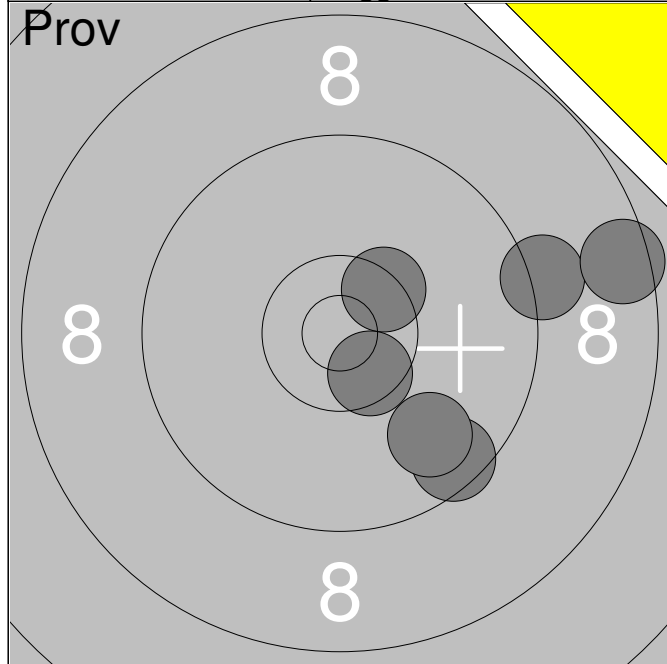

1:	9.5	↘
2:	9.2	→
3:	10.4x	↗
4:	8.5	→
5:	9.8	↘
6:	10.5x	↘

Serie	55.0
Total	0.0

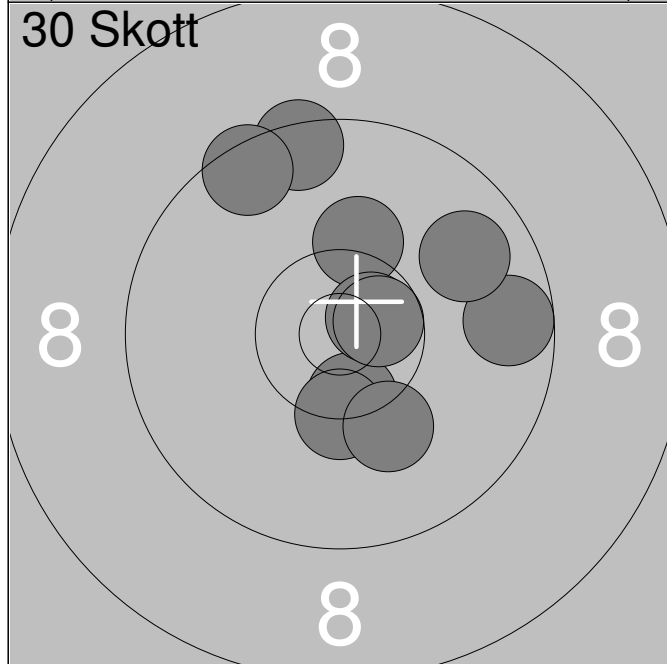

1:	9.7	→
2:	10.5x	↘
3:	9.5	↑
4:	9.5	↗
5:	10.3x	↘
6:	10.2	↑
7:	10.1	↘
8:	10.7x	↗
9:	9.8	↗
10:	10.6x	→

Serie	96.0
Total	96.0

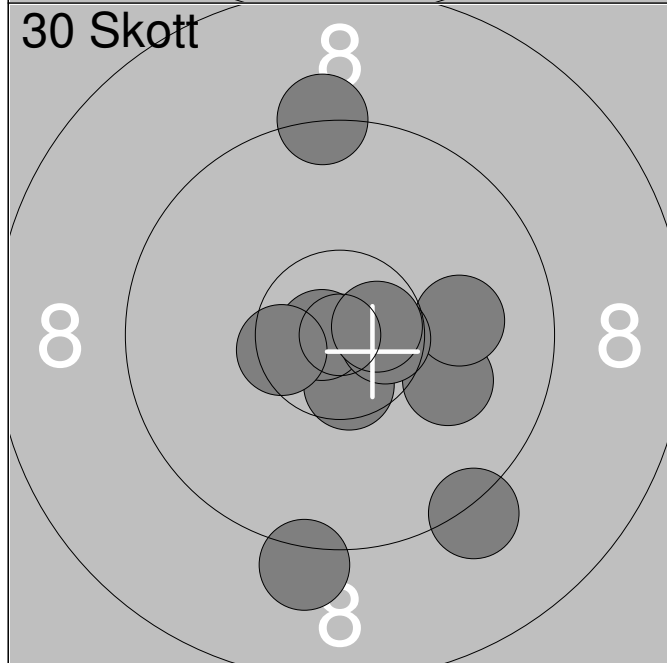

11:	10.6x	↘
12:	10.8x	←
13:	9.2	↘
14:	10.0	→
15:	9.2	↘
16:	10.0	→
17:	10.5x	←
18:	9.3	↑
19:	10.6x	→
20:	10.7x	→

Serie	97.0
Total	193.0

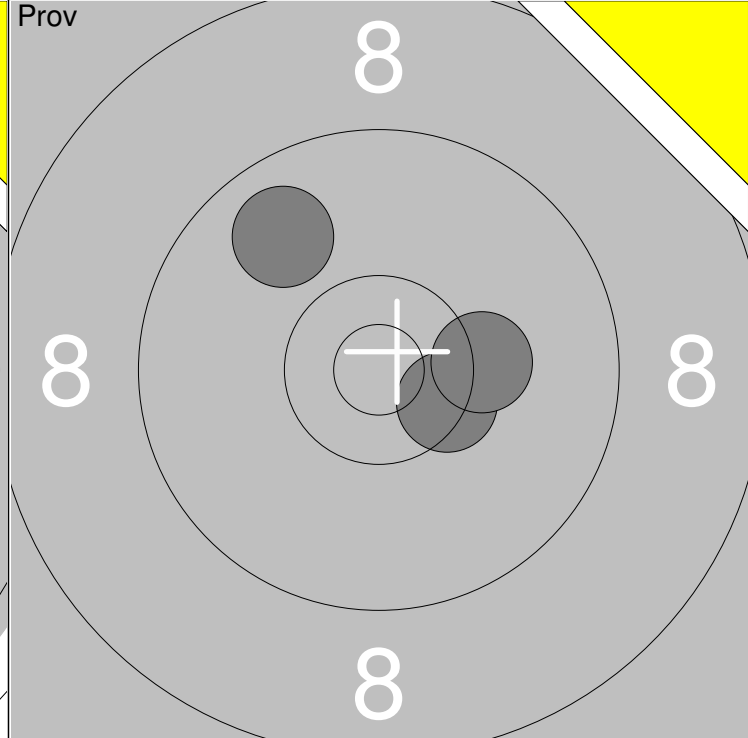
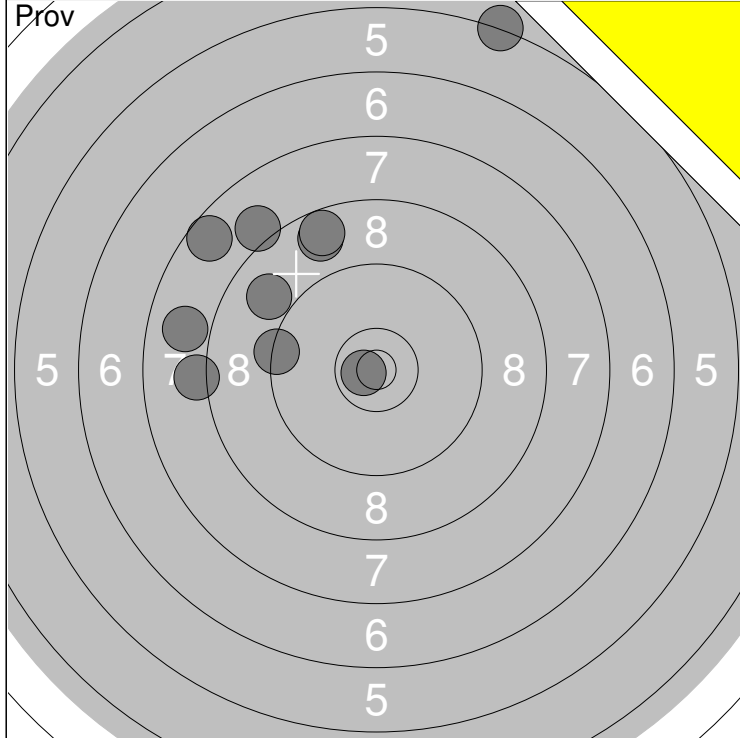

1: 5.3 ↗	6: 8.9 ↗	Serie	78
2: 8.7 ↗	7: 9.4 ↖		
3: 8.1 ↗	8: 7.6 ↗	Total	0
4: 7.9 ↖	9: 10.7x ↖		
5: 8.1 ↖	10: 8.7 ↗		

11: 9.8 ↗	Serie	29
12: 10.4x ↘		
13: 10.2 →	Total	0

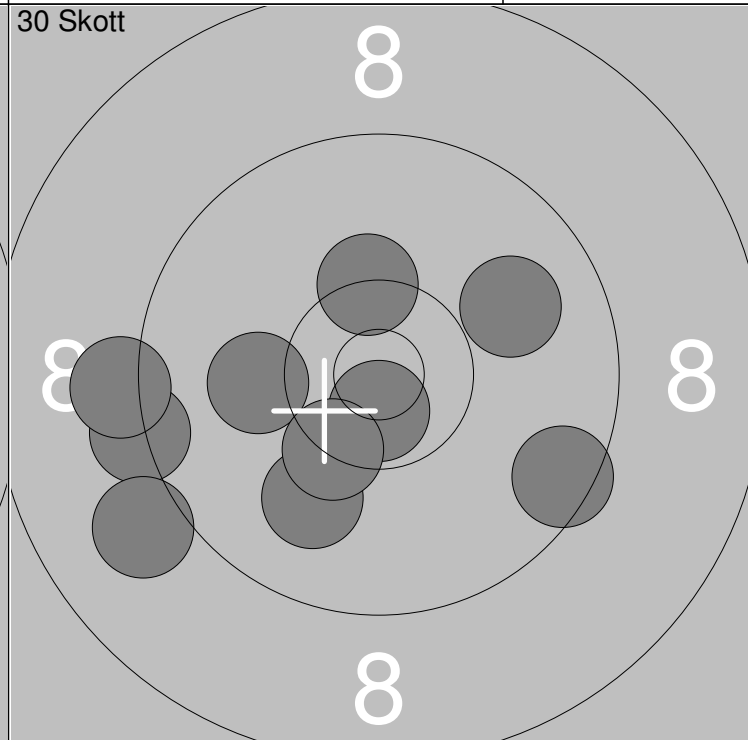
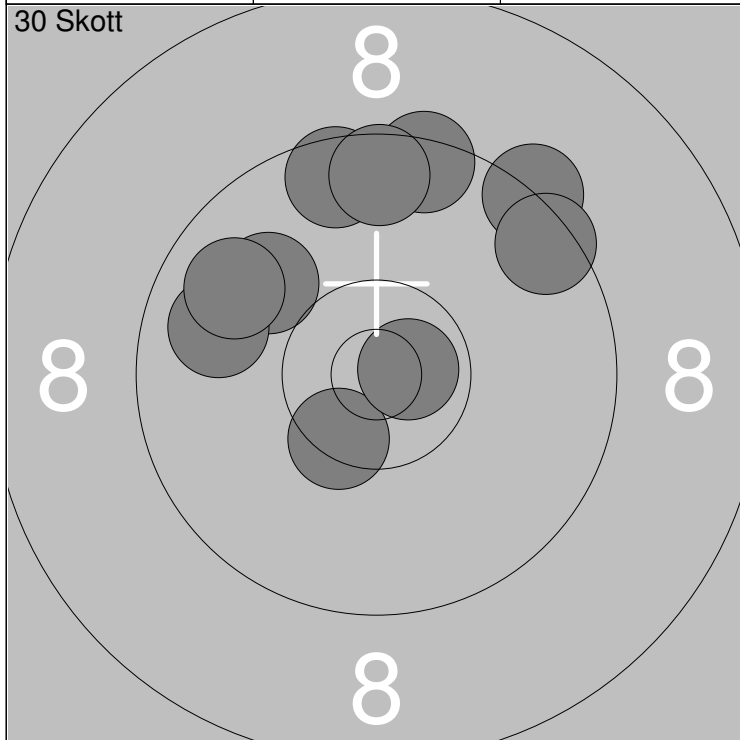

1: 10.4x ↘	6: 9.8 ↗	Serie	93
2: 10.0 ↗	7: 9.5 ↗		
3: 9.6 ↗	8: 9.6 ↗	Total	93
4: 9.8 ↖	9: 9.3 ↗		
5: 10.7x →	10: 9.5 ↗		

11: 9.3 ↖	16: 9.2 ↖	Serie	95
12: 10.7x ↓	17: 10.3x ↘		
13: 10.1 ↖	18: 9.9 ↗	Total	188
14: 10.3x ↗	19: 9.5 ↘		
15: 10.0 ↘	20: 9.0 ↖		



	1:	8.9	↖
	2:	10.2	↗
	3:	9.8	↗
Serie			27.0
Total			0.0

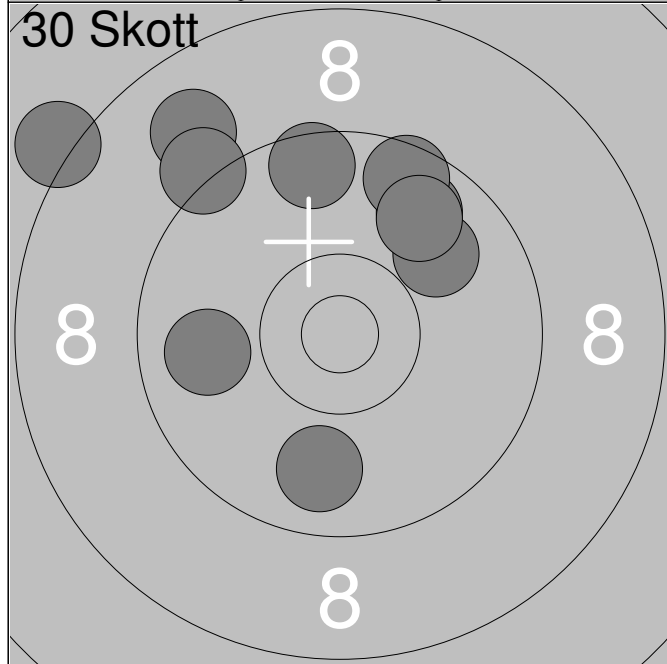

	1:	9.9	←
	2:	8.2	↗
	3:	8.9	↗
	4:	9.8	↗
	5:	9.2	↗
	6:	9.9	↗
	7:	9.8	↓
	8:	9.6	↗
	9:	9.6	↗
	10:	9.8	↗
Serie			88.0
Total			88.0

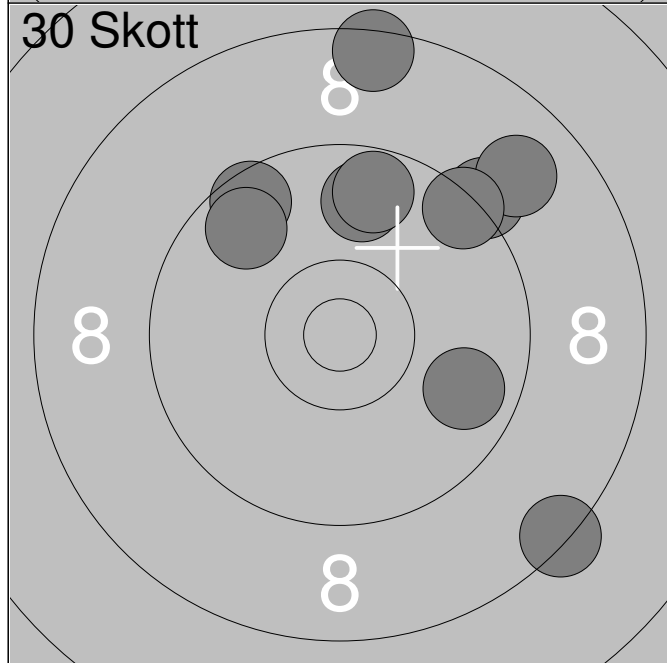

	11:	9.2	↗
	12:	8.9	↗
	13:	9.6	↗
	14:	9.4	↗
	15:	9.8	→
	16:	8.5	↗
	17:	9.7	↗
	18:	9.8	↗
	19:	9.7	↗
	20:	8.4	↘
Serie			87.0
Total			175.0

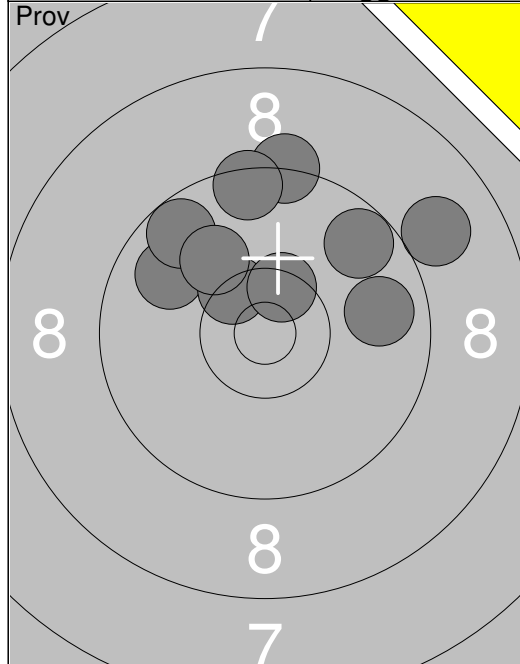

1: 9.0 ↗
2: 9.8 ↖
3: 10.4x ↖
4: 9.7 ↗
5: 9.8 →
6: 9.3 ↑
7: 9.6 ↖
8: 10.1 ↖
9: 9.5 ↑
10: 10.5x ↗
Serie 93.0
Total 0.0

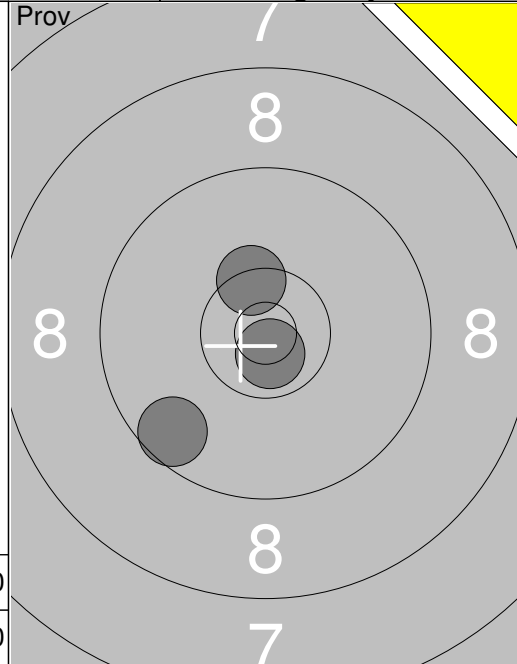

11: 10.7x ↓
12: 9.6 ↖
13: 10.4x ↗
Serie 29.0
Total 0.0

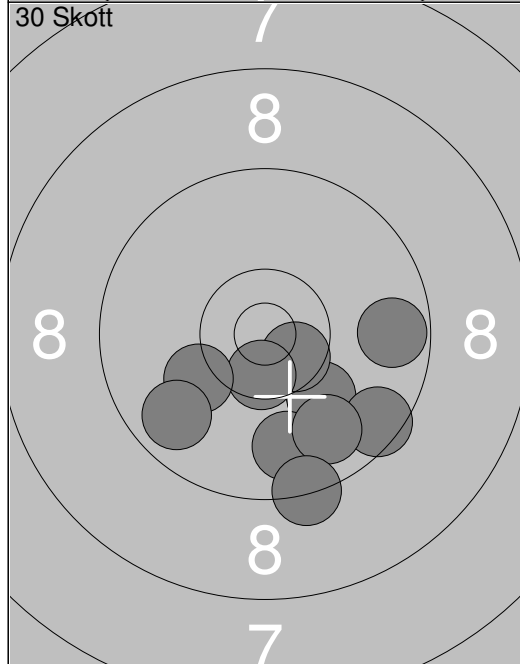

1: 10.1 ↓
2: 9.8 ↓
3: 9.5 ↓
4: 9.7 →
5: 10.6x ↓
6: 10.5x ↓
7: 10.2 ↖
8: 9.8 ↖
9: 9.8 ↓
10: 9.3 ↓
Serie 94.0
Total 94.0

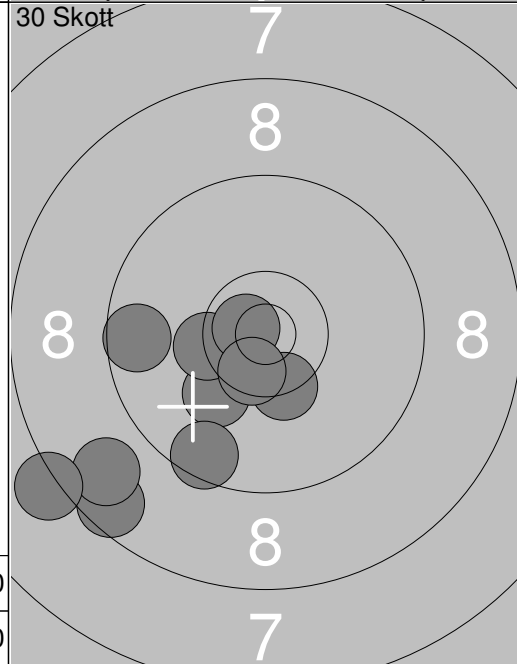

11: 10.2 ↖
12: 10.3x ↖
13: 8.6 ↖
14: 8.8 ↖
15: 9.6 ←
16: 10.4x ↓
17: 10.7x ↖
18: 9.5 ↓
19: 10.5x ↓
20: 8.2 ↖
Serie 92.0
Total 186.0

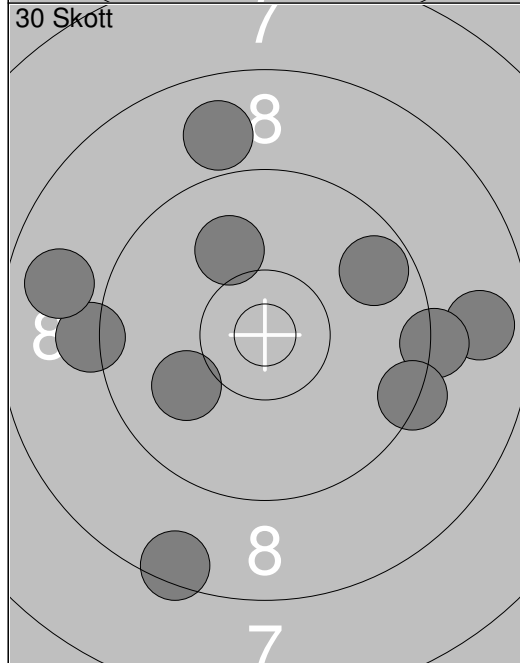

21: 9.2 ←
22: 8.5 ↓
23: 8.8 →
24: 9.3 →
25: 10.0 ↖
26: 8.9 ↑
27: 8.8 ↖
28: 9.4 ↘
29: 10.0 ↗
30: 9.7 ↗
Serie 88.0
Total 274.0

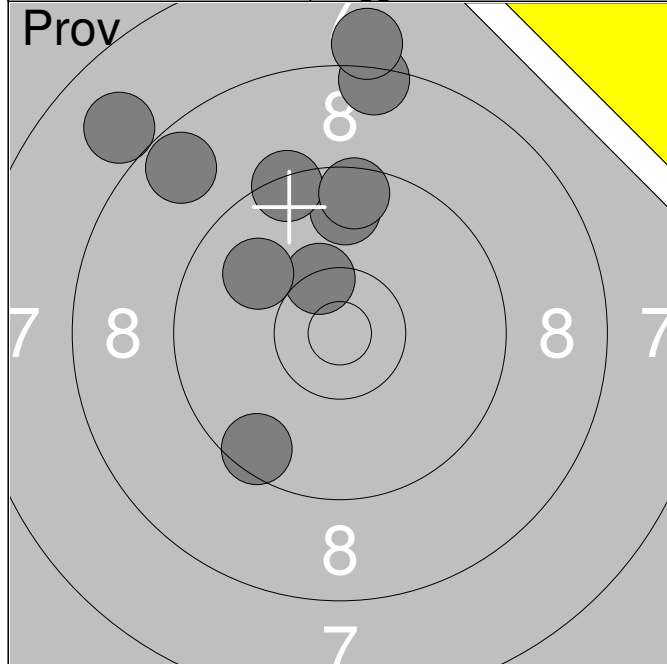

1:	8.4	↑
2:	9.5	↙
3:	8.7	↖
4:	9.7	↑
5:	10.4x	↑
6:	8.1	↑
7:	8.0	↖
8:	9.4	↑
9:	9.6	↑
10:	9.9	↖
Serie		87.0
Total		0.0

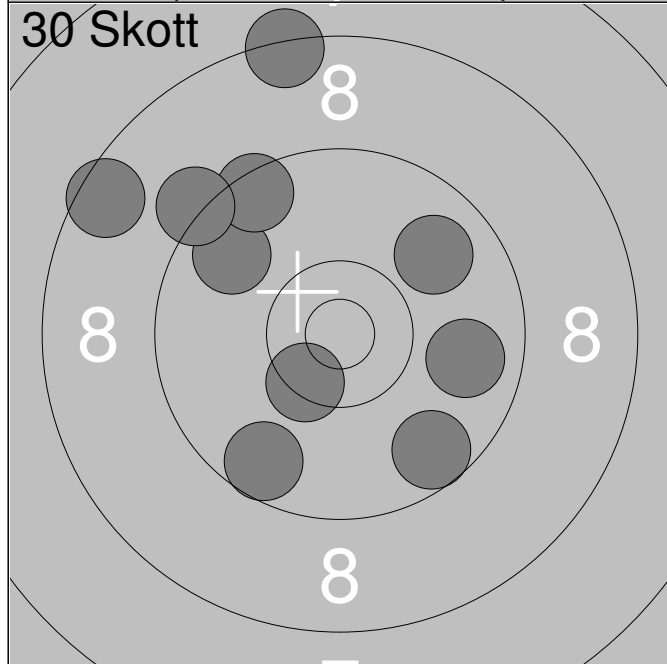

1:	8.4	↑
2:	9.6	↙
3:	9.8	↖
4:	8.5	↖
5:	10.4x	↙
6:	9.8	→
7:	9.6	↙
8:	9.9	↖
9:	9.5	↑
10:	9.2	↖
Serie		89.0
Total		89.0

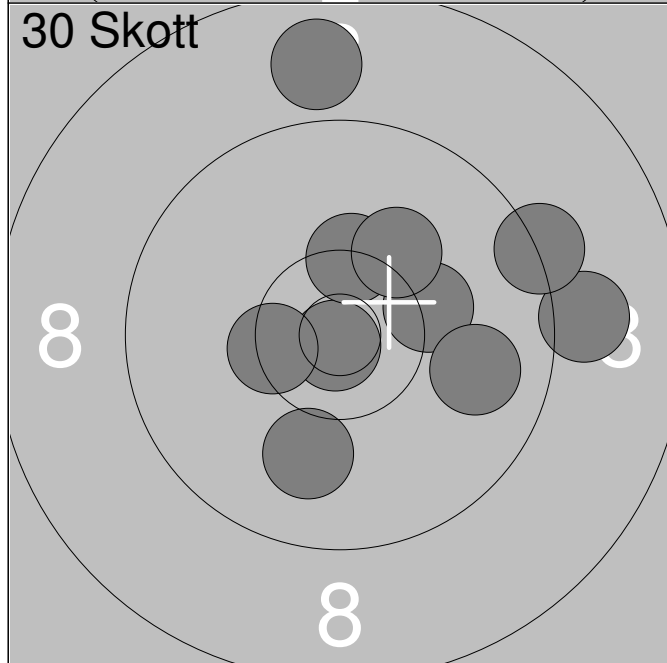

11:	10.0	↙
12:	10.9x	↙
13:	10.4x	↑
14:	8.9	↑
15:	10.4x	←
16:	10.2	→
17:	9.1	→
18:	9.3	→
19:	9.9	→
20:	10.2	↖
Serie		95.0
Total		184.0

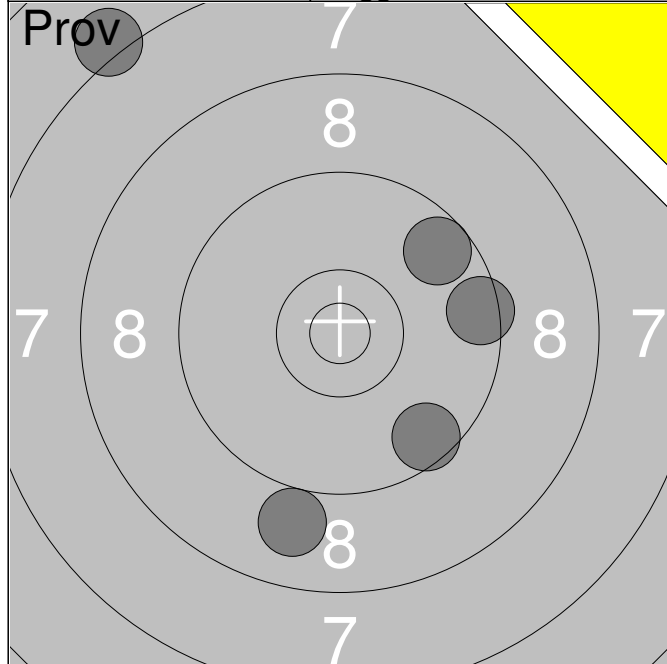

	1:	9.6	↘
	2:	9.0	↘
	3:	9.5	→
	4:	9.6	↗
	5:	7.1	↖

Serie	43.0
Total	0.0

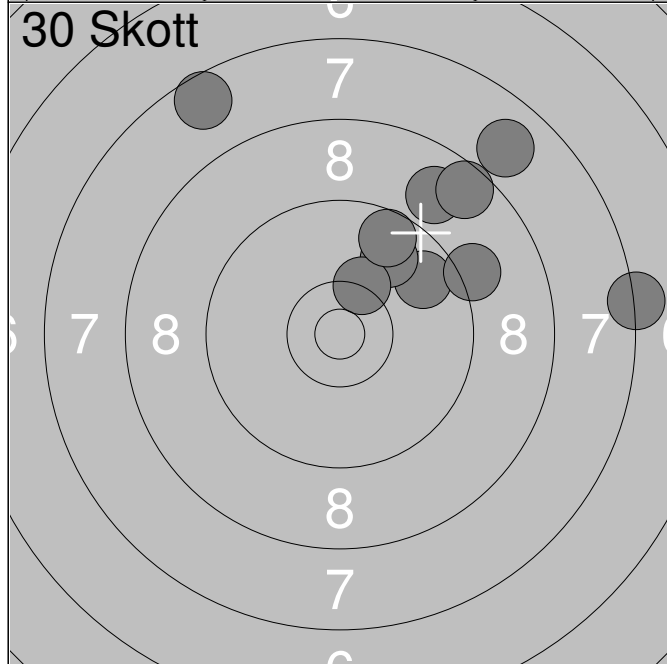

	1:	7.6	↖
	2:	7.9	↗
	3:	9.7	↗
	4:	7.3	→
	5:	9.8	↗
	6:	8.9	↗
	7:	8.6	↗
	8:	10.3x	↗
	9:	9.6	↗
	10:	9.1	→

Serie	83.0
Total	83.0

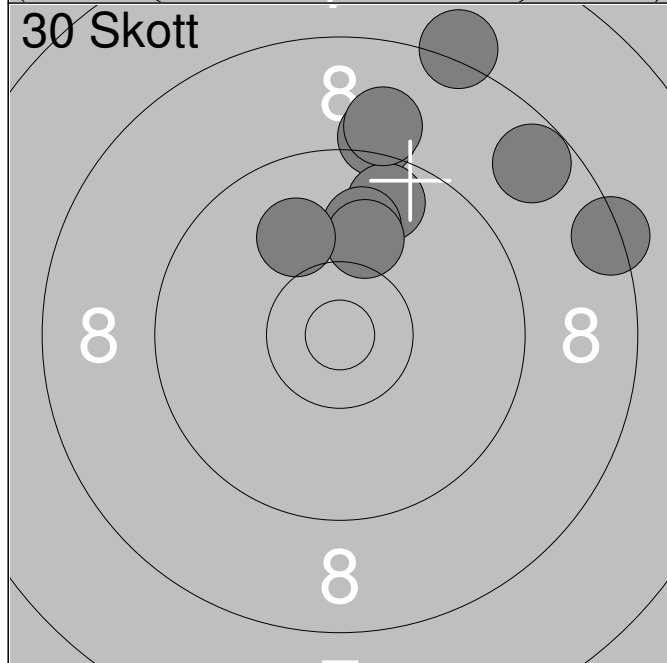

	11:	9.2	↑
	12:	9.7	↑
	13:	10.0	↑
	14:	8.4	→
	15:	10.1	↑
	16:	9.0	↑
	17:	10.0	↖
	18:	8.7	↗
	19:	8.2	↑

Serie	81.0
Total	164.0

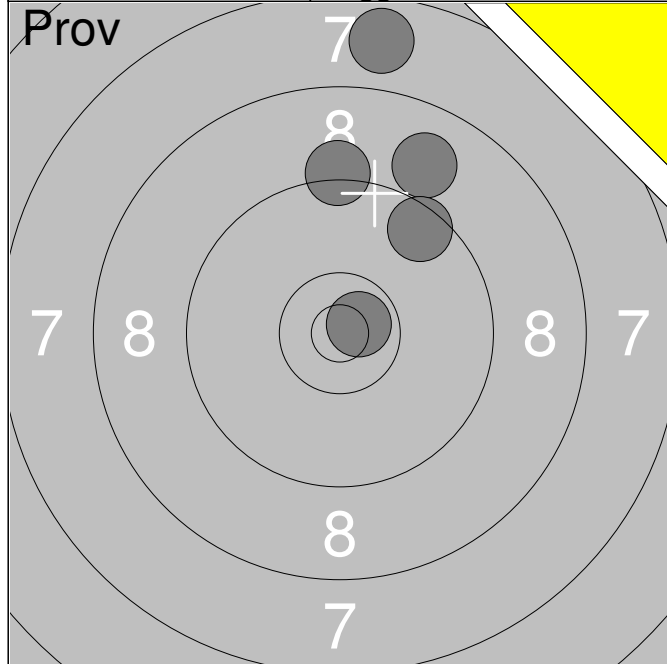

1:	9.2	↑
2:	7.8	↑
3:	10.7x	→
4:	8.9	↑
5:	9.5	↗
Serie		43.0
Total		0.0

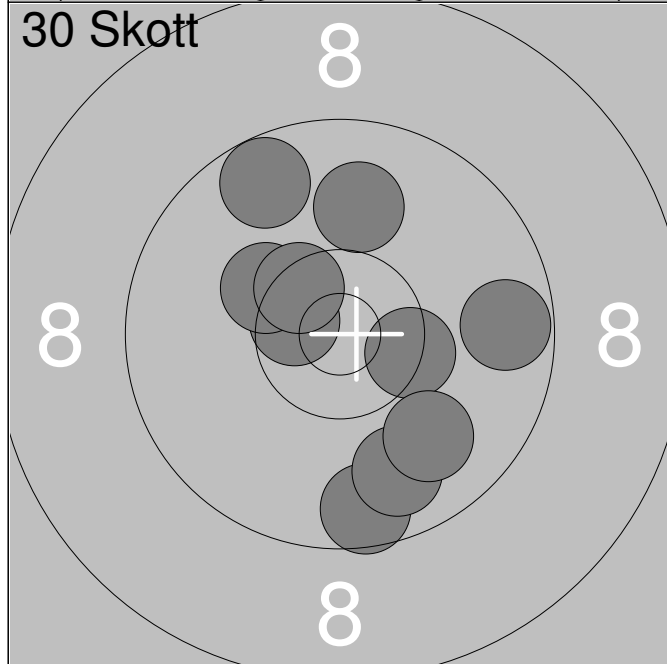

1:	9.6	↓
2:	10.6x	←
3:	10.3	↗
4:	10.5x	↗
5:	9.7	→
6:	9.8	↓
7:	10.4x	→
8:	10.0	↑
9:	9.6	↗
10:	9.9	↓
Serie		95.0
Total		95.0

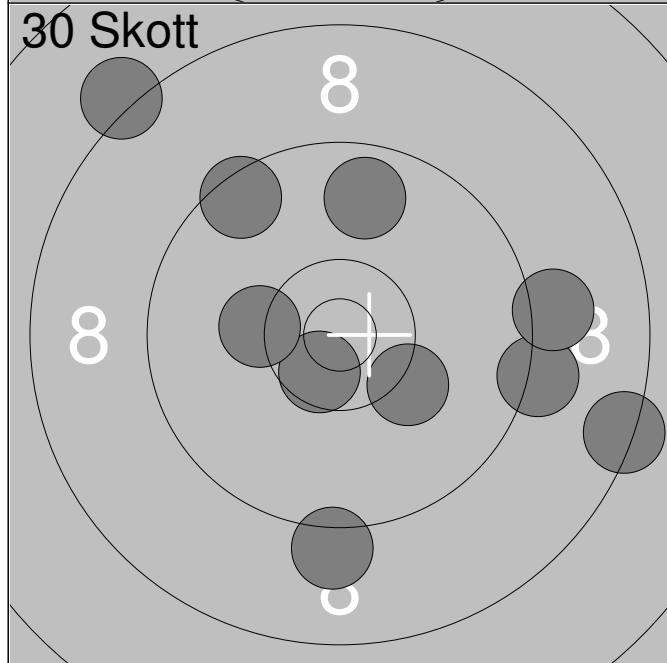

11:	9.5	↗
12:	10.6x	↓
13:	9.1	↓
14:	10.2	↓
15:	8.4	→
16:	9.2	→
17:	8.2	↗
18:	10.3	←
19:	9.1	→
20:	9.8	↑
Serie		91.0
Total		186.0

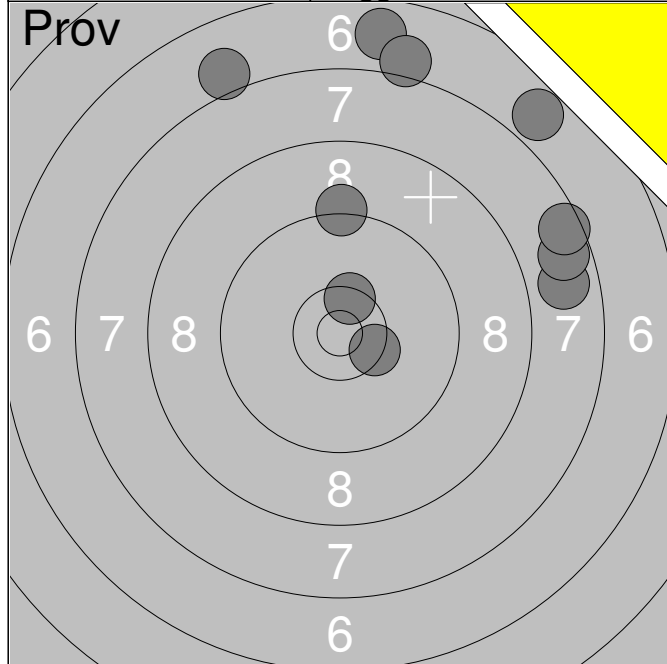

1:	6.8	↑
2:	9.2	↑
3:	10.4x	↑
4:	7.8	→
5:	6.9	↗
6:	7.0	↖
7:	7.1	↑
8:	7.7	→
9:	10.4x	→
10:	7.5	→
Serie		76.0
Total		0.0

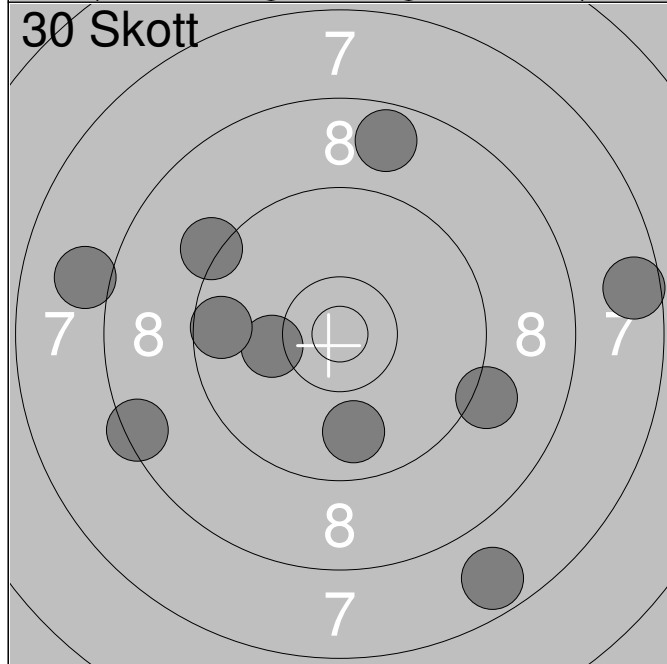

1:	8.0	←
2:	9.2	↖
3:	8.7	↑
4:	7.7	↓
5:	10.2	←
6:	7.6	→
7:	9.6	←
8:	9.2	→
9:	8.4	←
10:	9.8	↓
Serie		84.0
Total		84.0

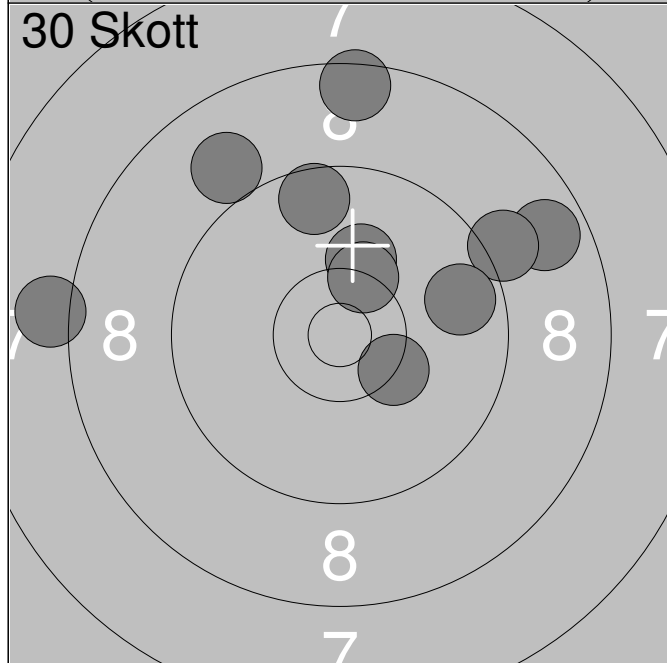

11:	8.7	→
12:	10.3x	→
13:	9.1	→
14:	9.6	↑
15:	10.2	↑
16:	10.3x	↑
17:	9.7	→
18:	8.5	↑
19:	8.1	←
20:	9.0	↖
Serie		90.0
Total		174.0

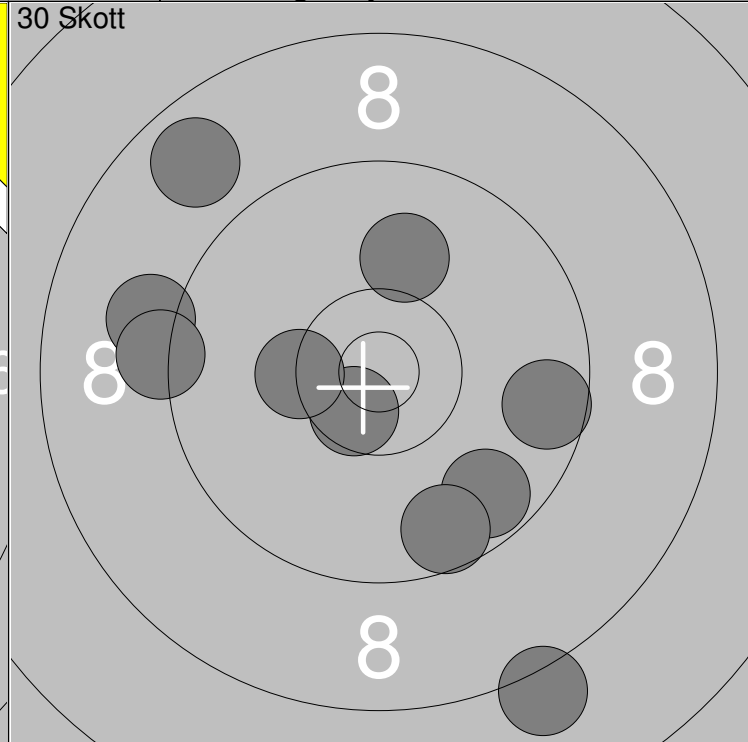
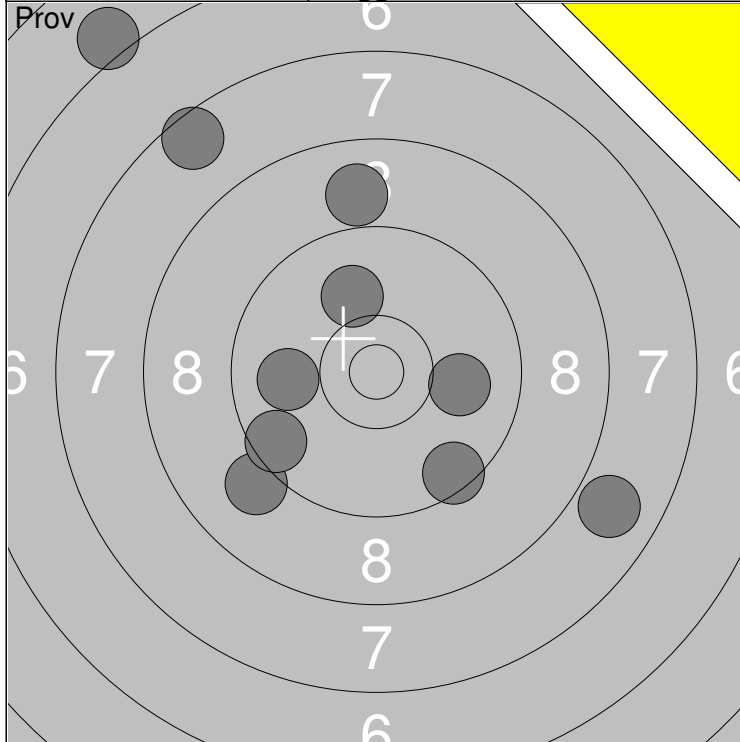

1: 9.5 ↘	6: 6.1 ↗	Serie	84
2: 9.1 ↙	7: 7.6 ↗		
3: 9.6 ↙	8: 10.0 ↗	Total	0
4: 7.9 ↘	9: 8.9 ↗		
5: 9.9 ←	10: 10.0 →		

1: 9.6 →	6: 9.6 ↓	Serie	91
2: 10.0 ↑	7: 10.3x ←		
3: 8.1 ↓	8: 9.1 ←	Total	91
4: 9.7 ↓	9: 9.2 ←		
5: 10.6x ↙	10: 8.8 ↗		

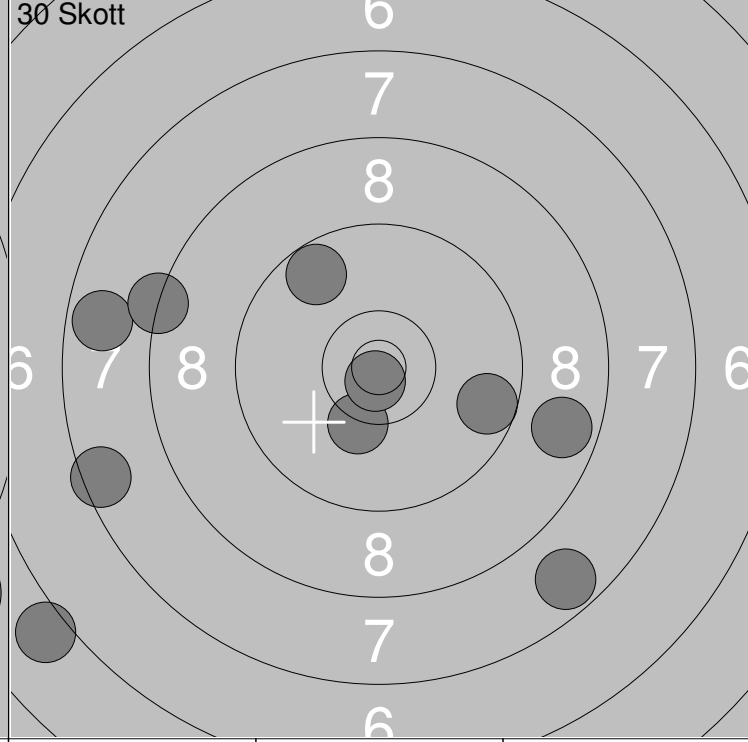
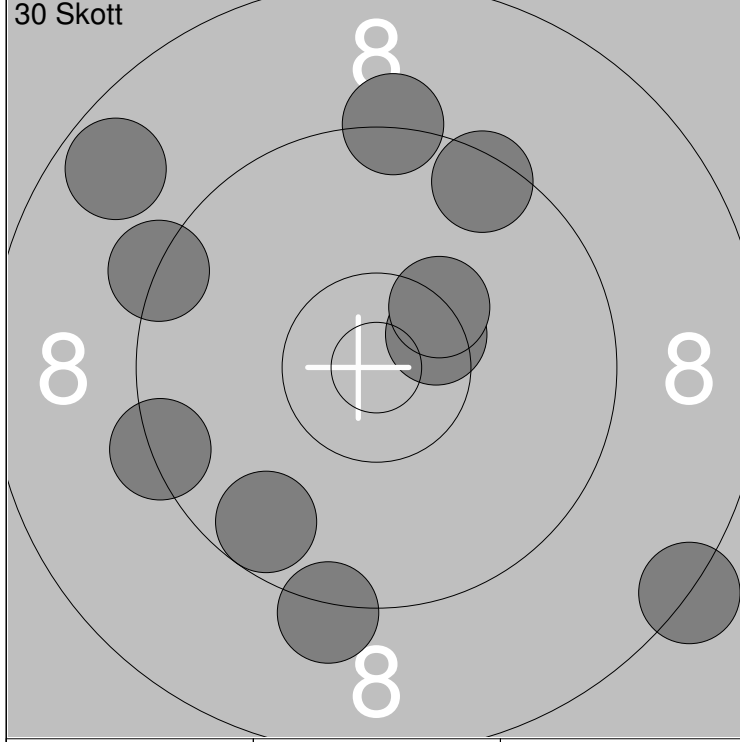

11: 9.3 ↙	16: 9.6 ↓	Serie	90
12: 9.5 ↗	17: 10.4x ↗		
13: 9.3 ↑	18: 9.4 ←	Total	181
14: 8.7 ↙	19: 8.3 ↘		
15: 10.5x ↗	20: 9.2 ↓		

21: 9.7 ↗	26: 8.3 ←	Serie	81
22: 10.3 ↓	27: 10.8x ↓		
23: 7.7 ←	28: 9.6 →	Total	262
24: 6.0 ↙	29: 8.7 →		
25: 7.5 ←	30: 7.7 ↓		

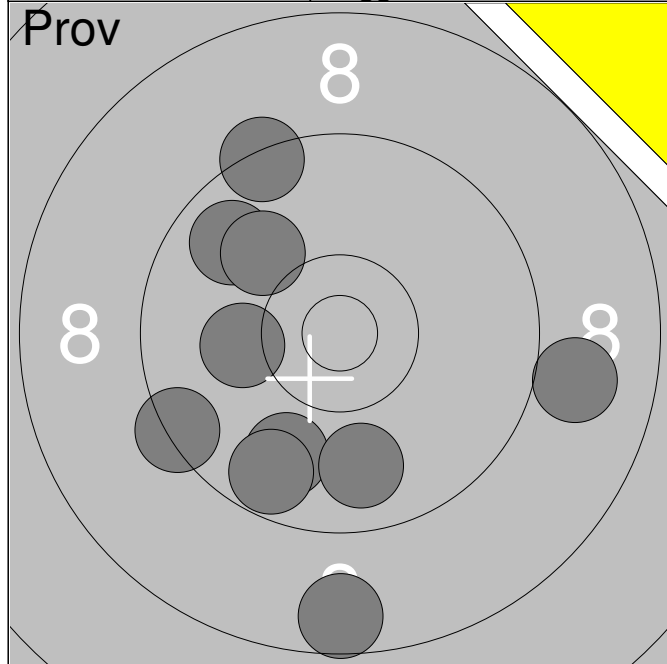

1:	9.8	↙
2:	9.0	→
3:	8.6	↓
4:	9.4	↙
5:	9.8	↓
6:	9.7	↙
7:	9.4	↗
8:	9.8	↗
9:	10.0	↗
10:	10.1	←
Serie		91.0
Total		0.0

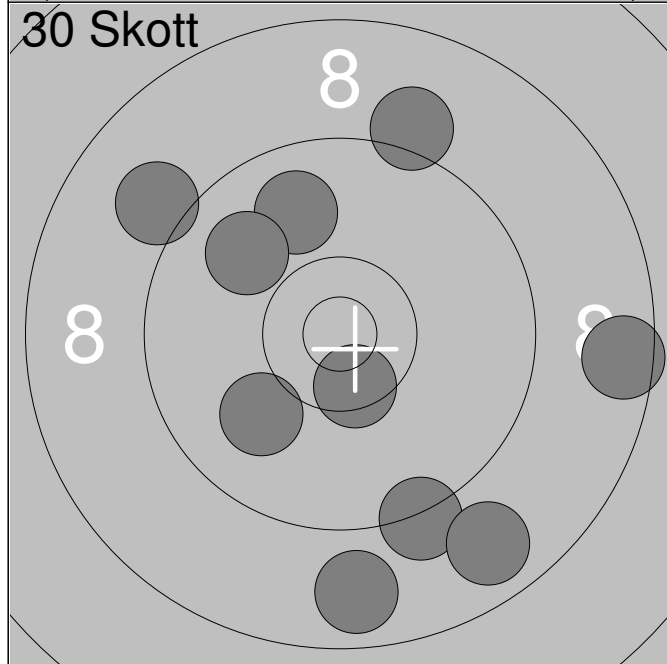

1:	8.8	↓
2:	9.3	↓
3:	9.1	↗
4:	10.0	↙
5:	8.6	→
6:	10.5x	↓
7:	9.9	↗
8:	9.1	↗
9:	9.9	↗
10:	8.8	↓
Serie		89.0
Total		89.0

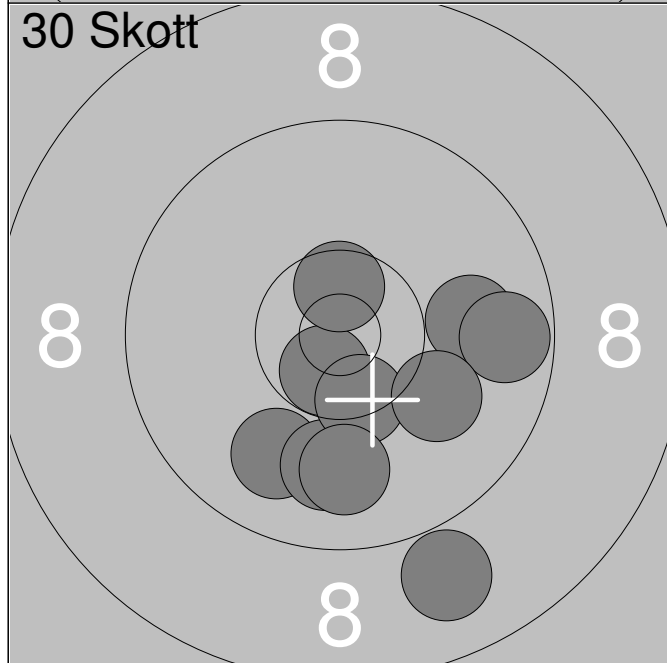

11:	10.7x	↓
12:	9.9	↓
13:	10.6x	↑
14:	9.9	↓
15:	9.9	→
16:	10.4x	↓
17:	9.7	→
18:	9.9	↓
19:	10.1	↓
20:	8.9	↓
Serie		93.0
Total		182.0



1:	3.5	↑
2:	7.1	↖
3:	7.9	↑
4:	10.3	↑
Serie		27.0
Total		0.0

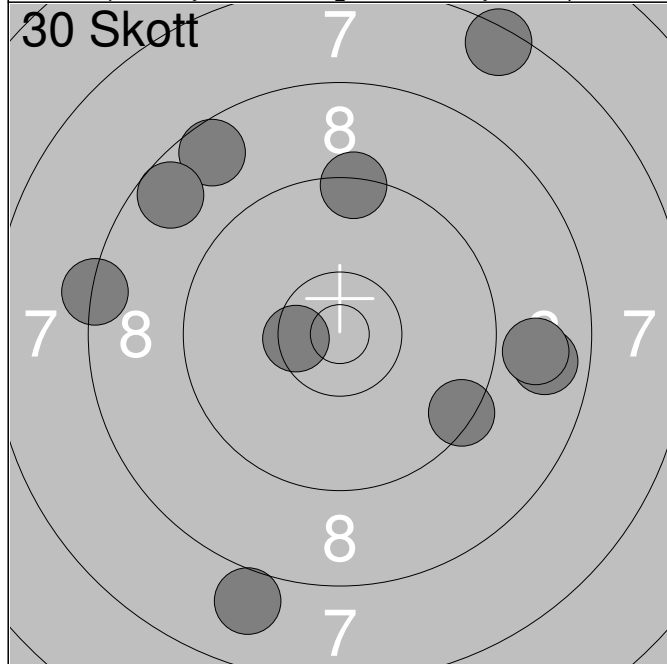

1:	9.4	↑
2:	8.6	↖
3:	8.0	↓
4:	9.4	↘
5:	8.8	→
6:	7.5	↗
7:	10.5x	←
8:	8.3	←
9:	8.6	↗
10:	8.9	→
Serie		83.0
Total		83.0

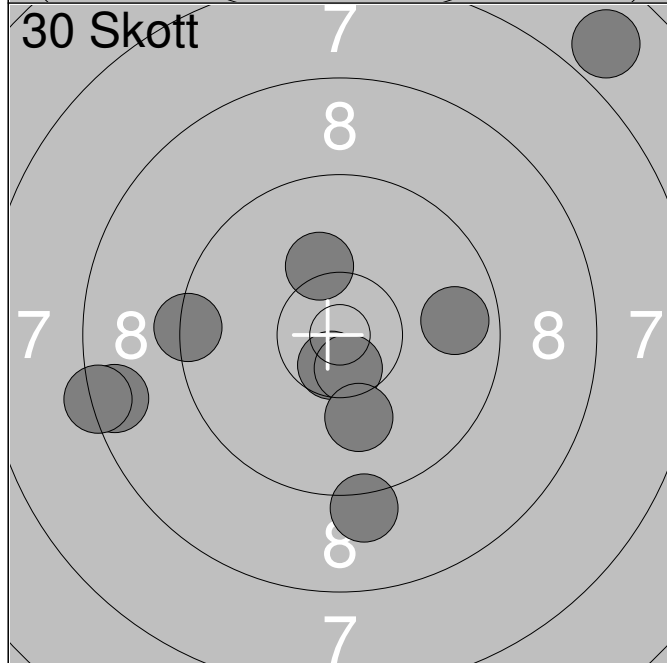

11:	10.6x	↓
12:	8.5	←
13:	8.4	←
14:	10.6x	↓
15:	9.1	↓
16:	10.2	↑
17:	9.8	→
18:	10.1	↓
19:	9.4	←
20:	6.9	↗
Serie		89.0
Total		172.0